



ROSE
ELECTRONICS

UltraMatrix 4X

OVERVIEW

- **Access up to 1000 computers from four keyboards, monitors, and mice**
- **Full non-blocking access from 4 KVMs**
- **Multi-platform for PC, Sun, RS/6000, HP, DEC, SGI, and others**
- **Plug-in cards makes the system easy to expand and maintain**
- **Integrated auto-switching power supply, 110/220 VAC**
- **Advanced on-screen display technology**
- **Rich set of features for security and access**



ROSE
ELECTRONICS

UltraMatrix 4X

HARDWARE

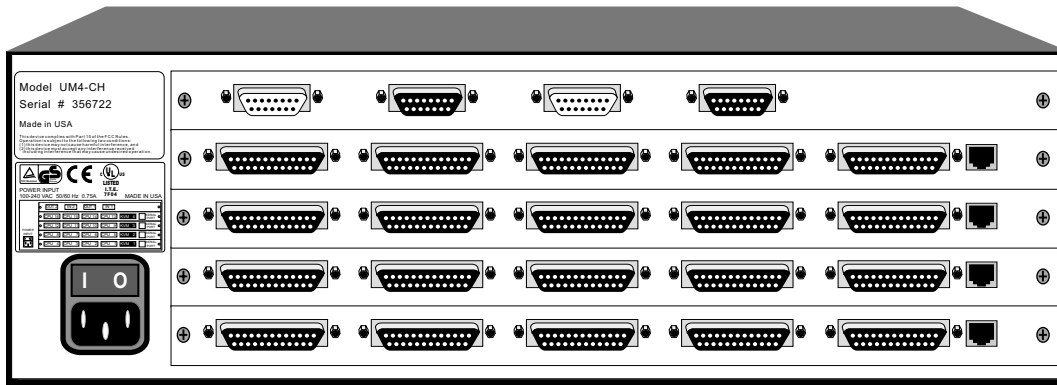

Expansion ports: 2 bus in(female), 2 bus out(male)
2 video connections per bus

Fully populated 4 x 16
unit with expansion

16 CPU ports

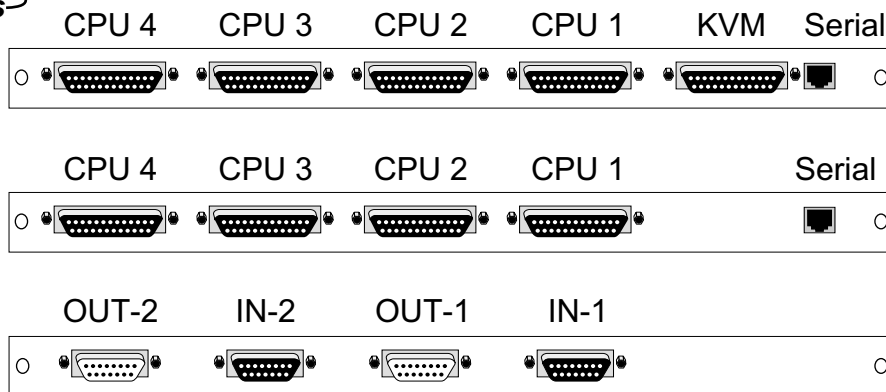

4 KVM ports

Plug-in card for 4 CPUs and 1 KVM

Plug-in card for 4 CPUs

Plug-in card for expansion
when not populated use
terminator board



ROSE
ELECTRONICS

UltraMatrix 4X

EXPANSION

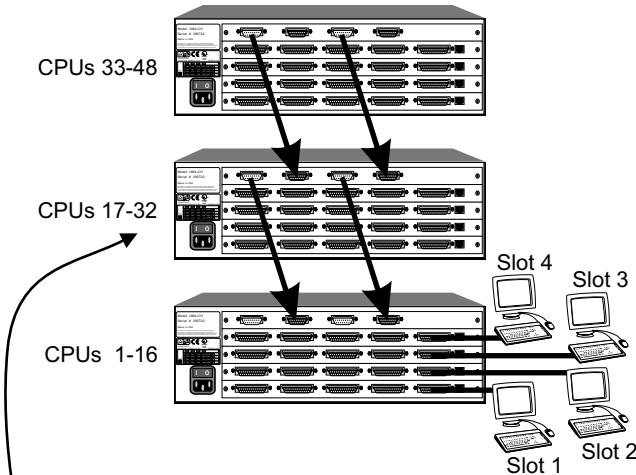

Connecting units together
KVMs clustered together
Same bus direction

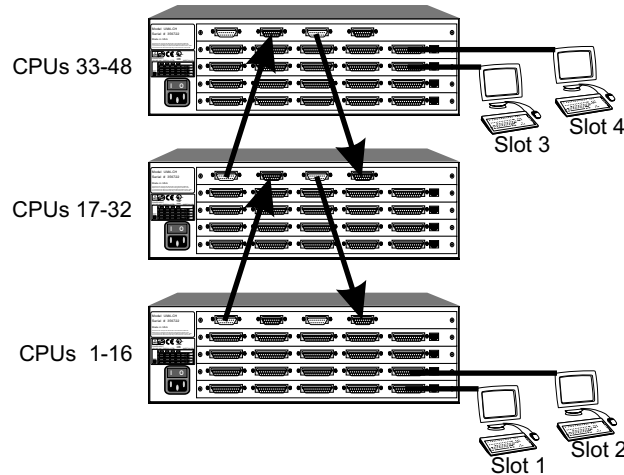

Connecting units together
KVMs separated in 2 locations
Split bus direction

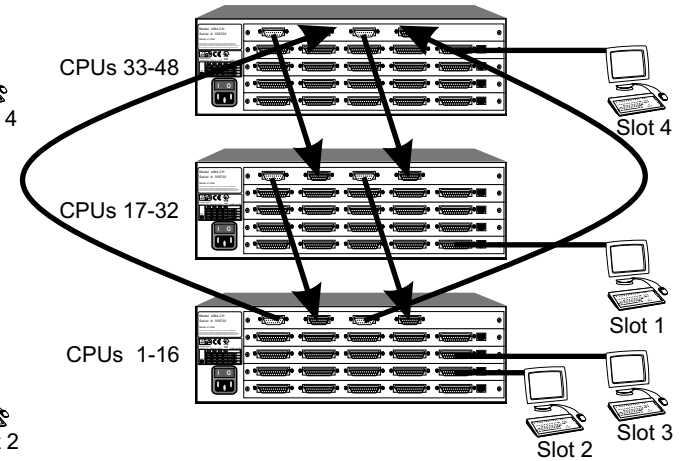

Connecting units together
KVMs distributed
Ring connection
*Two adjacent units
must have bus jumpers
removed on expansion cards*

Note on bus direction: KVMs can not see video from downstream boxes.

Example: KVMs on this box can see video from CPUs 33-48, but can not see video from CPUs 1-16



ROSE
ELECTRONICS

UltraMatrix 4X

MORE THAN 4 KVMS

The UltraMatrix supports up to 4 KVMS with non-blocking access. You can connect more than 4 KVMS, usually for local access to computers on a specific box. This will create some blocking as described further.

The concept of a local KVM is a useful one. It is often desirable to have a KVM located right next to the CPUs for maintenance or access to the CPU's drives, network connection, or other physical access.

When a KVM connects outside of its box, this will cause a conflict with all KVMS on the same slot position. The new connection will cause a "video path cancel" message to appear on all KVMS at the same slot position.

As long as all KVMS on a given slot position connect only to CPUs in their own box, then there will be no video conflict. As soon as any of the KVMS on a given slot position connect to a CPU outside of their box, then all other KVMS on that slot position will get a video path cancel.

In the example shown here, there are three slot 1 KVMS, which can have potential conflicts. KVMS on slots 2, 3, and 4 will never have any conflicts.

It is possible to configure the system to prevent access of a KVM to CPUs outside of its box, preventing conflicts from ever occurring. This is done by giving each KVM a profile with an access group set to include only its CPU ports.

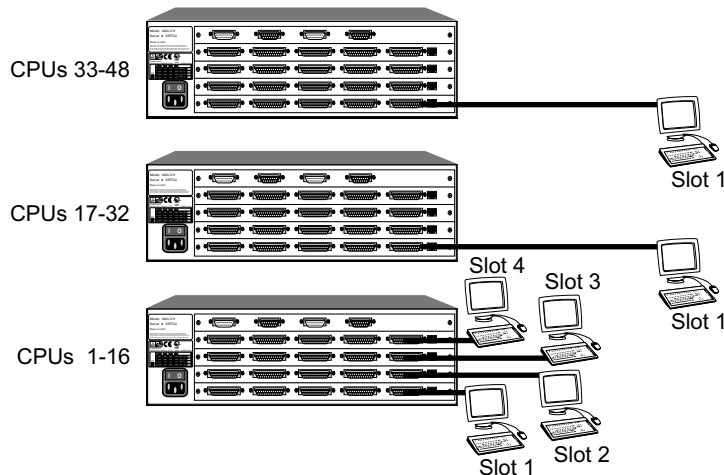



ROSE
ELECTRONICS

UltraMatrix 4X

VIDEO PATH

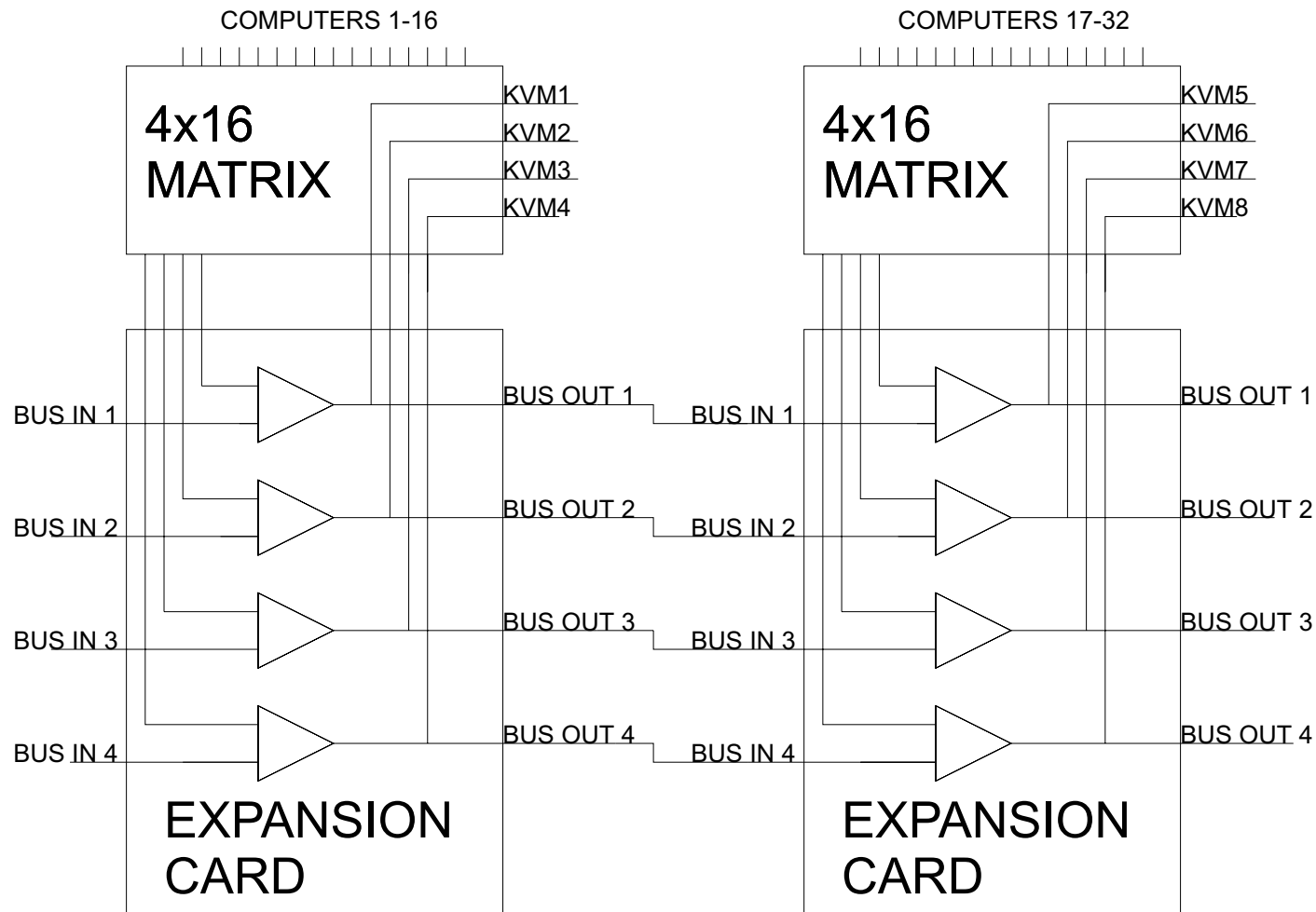



ROSE
ELECTRONICS

UltraMatrix 4X

POWER UP DIAGNOSTICS

```
UltraMatrix version MX16 Rose Electronics Copyright 1990-1999
```

```
Power on diagnostics
```

```
Kernel version    KX14  
Overlay version   031B  
Kernel program    Good  
Static ram        Good  
Configuration     Good  
Board number      2  
Communication ID   6  
Communication     Good  
Local ports       8  
Program version   MX15  
Main program      Good  
PC keyboard detected  
PS2 mouse detected
```



This screen comes from the on-screen display when the switch first turns on. If there is a failure of the self test, then the reason will be displayed. This screen is blue with white letters.

Slot position in chassis
Address of card in system,
1= CPUs 1-4, 2=CPUs 5-8, 3=CPUs 9-12, and so on
Number of CPU cards present in chassis



ROSE
ELECTRONICS

UltraMatrix 4X

MAIN CONFIGURATION MENU

This screen comes from the on-screen display by pressing and releasing the left control key and the hitting the F12 key. From this page, you reach all other pages to configure the unit.

Navigation through the menus is very simple, use the arrow keys to go to an item and hit enter to go to that page or to change a value. The help line at the bottom, changes to explain what each setting is. When changing a value, pop-up boxes appear,

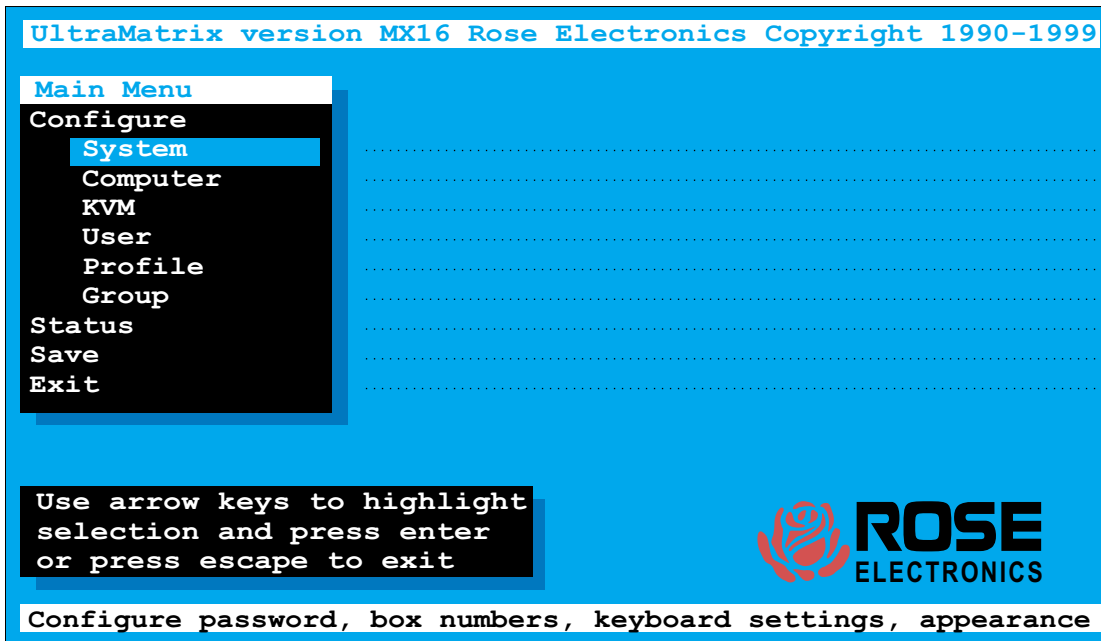

LIST OF HELP MESSAGE FOR EACH ITEM

- Configure password, box numbers, keyboard settings, appearance
- Configure computer names, keyboard, and mouse type
- Configure KVM name, resolution, start port, and login mode
- Configure user name, password, and profile
- Configure user access and other settings
- Configure group names and which computers are in groups
- Show communication and connection status
- Sends configuration to system and saves to flash memory
- Exit this menu and return to normal operation



CONFIGURE SYSTEM

```

Configure system
System settings
Configure password *****
Starting computer number 1
Maximum computer 64
Keyboard settings
PC keyboard rate (chars/sec) 20
PC keyboard delay Fast
Sun keyboard language US
Appearance
Menu color scheme Night sky
Screen saver Weaving
Screen saver time (seconds) 1200
Background color Cyan
Text color Black
Position X= 2 Y= 45
Fadeout (seconds) 5
Password to configure box
  
```

LIST OF HELP MESSAGE FOR EACH ITEM

- Password to configure box
- Number for first CPU on this box, rounded to multiple of 4 + 1
- Maximum number of computers in system
- Rate at which key down repeats (1-31)
- Delay time before key down starts to repeat
- Response to Sun computer's query for language type
- Colors of the configuration menu
- Shows pattern if no keyboard or mouse activity
- Time to screen saver, if no keyboard or mouse activity (0-9999)
- Background color of connection status and select menu
- Text color of connection status and select menu
- Position of connection status
- Connect status erase time(0-255), 0=don't show, 255=always show

This is a critical item to configure. The setting on the bottom card determines the addresses of the CPU in the chassis. The settings on the upper cards are ignored, they automatically follow the bottom card sequentially.
 1 = CPU 1-4, 5 = CPU 5-8, 9 = CPU 9-12, 13 = CPU 13-16 and so on



CONFIGURE COMPUTER

LIST OF HELP MESSAGE FOR EACH COLUMN

Configure computer

	Computer name	Keyboard	Mouse
1	Computer 1	PC2	PS2
2	Computer 2	PC2	PS2
3	Computer 3	PC2	PS2
4	Computer 4	PC2	PS2
5	Computer 5	PC2	PS2
6	Computer 6	PC2	PS2
7	Computer 7	PC2	PS2
8	Computer 8	PC2	PS2
9	Computer 9	PC2	PS2
10	Computer 10	PC2	PS2
11	Computer 11	PC2	PS2
12	Computer 12	PC2	PS2
13	Computer 13	PC2	PS2
14	Computer 14	PC2	PS2
15	Computer 15	PC2	PS2
16	Computer 16	PC2	PS2

Name of computer up to 16 characters
Use page up and page down keys to configure more computers

- Name of computer up to 16 characters
- Use page up and page down keys to configure more computers
- Type of computer, for PCs this is the computer's keyboard mode
- Type of computer mouse used, can be changed for PCs only



CONFIGURE KVM

Configure KVM

	KVM name	Resolution	Start	Login	User
1	KVM Station 1	640x480@60	0	No	User 1
2	KVM Station 2	640x480@60	0	No	User 2
3	KVM Station 3	640x480@60	0	No	User 3
4	KVM Station 4	640x480@60	0	No	User 4

Name of keyboard-video-mouse station(KVM), up to 16 characters

LIST OF HELP MESSAGE FOR EACH COLUMN

- If name/password not required, this user is assigned to KVM
- Required to enter user name/password to access computers
- Computer connected to when box is powered on, use 0 for none
- Resolution of on-screen-display when no external video
- Name of keyboard-video-mouse station (KVM), up to 16 characters



CONFIGURE USER

LIST OF HELP MESSAGE FOR EACH COLUMN

Configure User		
User name	Password	Profile
User 1	*****	Profil 1
User 2	*****	Profil 2
User 3	*****	Profil 3
User 4	*****	Profil 4
User 5	*****	Profil 5
User 6	*****	Profil 6
User 7	*****	Profil 7
User 8	*****	Profil 8
User 9	*****	Profil 9
User10	*****	Profil10
User11	*****	Profil11
User12	*****	Profil12
User13	*****	Profil13
User14	*****	Profil14
User15	*****	Profil15
User16	*****	Profil16

User login name, up to 8 characters

User login name, up to 8 characters

User password, up to 8 characters

User profile, controls access rights and other settings



CONFIGURE PROFILE

Configure Profile						
Name	Access	Connect	Share	Scan	Logout	
Profil 1	Group 1	Share	2	5	240	
Profil 2	Group 2	Share	2	5	240	
Profil 3	Group 3	Share	2	5	240	
Profil 4	Group 4	Share	2	5	240	
Profil 5	Group 5	Share	2	5	240	
Profil 6	Group 6	Share	2	5	240	
Profil 7	Group 7	Share	2	5	240	
Profil 8	Group 8	Share	2	5	240	
Profil 9	Group 9	Share	2	5	240	
Profil10	Group11	Share	2	5	240	
Profil12	Group12	Share	2	5	240	
Profil13	Group13	Share	2	5	240	
Profil14	Group14	Share	2	5	240	
Profil15	Group15	Share	2	5	240	
Profil16	Group16	Share	2	5	240	

Profile name, up to 8 characters

LIST OF HELP MESSAGE FOR EACH COLUMN

Profile name, up to 8 characters

Which group of computers a user may access

Which connect mode (view, share, control, or private) is used

Time(seconds) if no kb-ms activity, another can share computer

Time(seconds) in scan mode between switching to next computer

Time(minutes) with no kb-ms activity that CPU is disconnected



CONFIGURE GROUP

Configure Group

Computer	Group 2
1 Computer	1 + + + + + + + + + + + + + + + +
2 Computer	2 + + + + + + + + + + + + + + + +
3 Computer	3 + + + + + + + + + + + + + + + +
4 Computer	4 + + + + + + + + + + + + + + + +
5 Computer	5 + + + + + + + + + + + + + + + +
6 Computer	6 + + + + + + + + + + + + + + + +
7 Computer	7 + + + + + + + + + + + + + + + +
8 Computer	8 + + + + + + + + + + + + + + + +
9 Computer	9 + + + + + + + + + + + + + + + +
10 Computer	10 + + + + + + + + + + + + + + + +
11 Computer	11 + + + + + + + + + + + + + + + +
12 Computer	12 + + + + + + + + + + + + + + + +
13 Computer	13 + + + + + + + + + + + + + + + +
14 Computer	14 + + + + + + + + + + + + + + + +
15 Computer	15 + + + + + + + + + + + + + + + +
16 Computer	16 + + + + + + + + + + + + + + + +

+ means computer belong to group PAGE UP/DOWN-more computers
SPACE BAR-adds/Removes computer from group ENTER-renames group

This page determines which computers belong to which group. Use the arrow keys to go to the desired row(computer) and column(group) and use the space bar to toggle whether that computer is a member of the group or not.

You can also hit enter to change the name of the group depending upon which column the cursor is in.



STATUS

System Status							
Computers	Power	Slot	Ver	KVM	CPU	User	Status
1-4	■■■■	1	013	PC	14	Bob	View mode
5-8	■ ■ ■ ■	2	013	PC	3	David	Share mode
9-12	■ ■ ■ ■	3	013	PC	14	Sharon	View mode
13-16	■■■■	4	013	Sun			Not logged in
17-20							No response
21-24							No response
25-28							No response
29-32							No response
33-36							No response
37-40							No response
41-44							No response
45-48							No response
49-52							No response
53-56							No response
57-60							No response
61-64							No response

Slot: card position/Ver: program version/KVM: PC, Sun, or none
CPU power: ■=on ■=off Line color: Connect/OK Disconnect Error

This is a very powerful feature that lets you see many things from one screen. Each data line can be green, yellow, or red.
Green means the KVM on that card is connected to a CPU
Yellow means the KVM is not connected
Red means the card does not exist or has an error

- Computers Which card it is
- Power Each square is green for power on to the CPU and red for power off to the CPU
- Slot Which slot the card is installed in
- Ver The firmware version of the main program
- KVM The type of KVM attached either none, PC, or Sun
- CPU If a connection is present, which computer the KVM is connected to
- User If a connection is present, which user is logged on the KVM
- Status What the state of the card is can be any of the following:

Connected (green)

- 1 View mode The KVM is connected in view mode
- 2 Share mode The KVM is connected in share mode
- 3 Control mode The KVM is connected in control mode
- 4 Private mode The KVM is connected in private mode

Disconnected (yellow)

- 5 Initial state Since power on, the KVM has never been connected
- 6 User request The user typed in a control Q command and disconnected
- 7 Timed out The disconnect timer elapsed and the user was disconnected
- 8 Video path cancel A conflict with a KVM on the same slot position caused a disconnect
- 9 Private mode cancel Another user in private mode overrode the connection
- 10 No response The last connect was to a non-existent computer
- 12 Not in access group Last attempt to connect was to computer not in access group of user
- 13 Computer is private Last attempt to connect was to a computer already connected to another user in private mode
- 14 Queue full More than 4 KVMs tried to connect to a single computer
- 15 Unknown reason Error, call tech support
- 16 Not logged in Log in is required and no user has logged in
- 17 Remote request The computer was disconnected by RS232 command

The numbers in the connect and disconnect states are result codes returned by the RS232 switching command.



ROSE
ELECTRONICS

UltraMatrix 4X

CONFIGURATION MENU SAVE

UltraMatrix version MX16 Rose Electronics Copyright 1990-1999

Main Menu

- Configure
- System
- Computer
- KVM
- User
- Profile
- Group
- Status
- Save**
- Exit

boards to update=3

Progress bar: [██████████] [██████████]

Saving to flash

Use arrow keys to highlight selection and press enter or press escape to exit

Sends configuration to system and saves to flash memory



The save function is used to save all the settings in flash memory. The configuration is automatically sent to all the other boards in the system. The number of boards (other than the one you are on) is listed and a progress bar is shown as the flash memory is saved.



SWITCHING TO COMPUTERS

```

Computer select menu
1 Mail Server
2 NT Server 1
3 NT Server 2
4 NT Server 3
5 Inventory
6 Inventory 2
7 Sales domain
8 Computer      8
9 Computer      9
10 Computer     10
11 Computer     11
12 Computer     12
13 Computer     13
14 Computer     14
15 Computer     15
16 Computer     16

```

You can switch to computers through three different methods:

- COMPUTER SELECT MENU** - Pressing and releasing the left control and then hitting the escape key brings up the computer select menu. Use the arrow keys and the page up and page down to highlight a computer and hit enter to switch to it.
- DIRECT BY NUMBER** - If you know the number of the computer you want to switch to then press and release the left control key, enter the numeric value using the number keys below the function keys, and hit enter to switch.
- USING THE RS232 port** - Specify the KVM value with Knnn where nnn is the 1-255 KVM number of the card desired. Specify the CPU number with Cnnnn where nnnn is the 1 to 1000 computer number of the CPU desired. Send S to switch or question for an inquiry. <cr> below means carriage return (value 13). The last value of K or C is remembered.
 For example: K1C3S<cr> Switches KVM 1 to computer 3
 For example: K2?<cr> Returns which computer KVM 2 is connected to in the form K2CnnnRxx<cr> where nnn is the computer connected or last connected and xx is the status value described previously on the status page.

The on-screen display gives you messages on the status of your connection and you will receive a message of the following type when connecting or disconnecting. The last line is the status and is very important for troubleshooting. This message may also be recalled with the control D command.

```

Status MIS Console
Connection successful
to NT Server
on Admin
Share mode

```

```

Status Control Room 5
Connect failed
to Mail Server
on Richard
Not in access group

```

```

Status App station 1
Disconnected
from Payroll
on Sharon
Timed out

```



ROSE
ELECTRONICS

UltraMatrix 4X

SECURITY

There are several types of security features in the product.

1. Configuration password

This feature is used to prevent unauthorized access to the configuration menus. The password is entered from the configure system page. Any subsequent access to the configuration page will require this password.

There is a password defeat jumper, in case the password is forgotten. The jumper is marked on the CPU cards. The unit is shipped with no jumper. If this jumper is installed., the unit will behave as if no password is present.

2. Switch login

On the configure KVM page there is a selection for login yes/no. If you say yes all access to the box from this KVM will require a user id and password as shown to the left. Once the password is entered correctly, the profile assigned to the user via the configure user page will be active. The settings of that profile are assigned on the configure profile page.

3. User access group

Each KVM has a user assigned to it. This is determined by the settings on the configure KVM page. If login=yes, then the user is from the value entered at the login box. If login=no, then the user name is from the user field adjacent to the login=no field. Each user has a profile from the configure user page and each profile has an access group. The access group can be configure to allow or deny access to any computer.

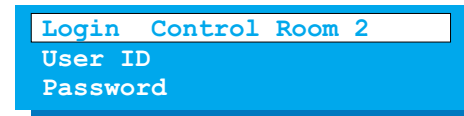
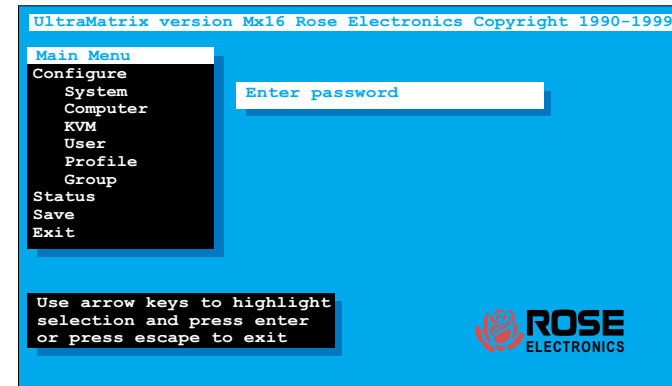



SERIAL OPTIONS MENU

Hit space bar within 5 seconds of power-on of unit
Primarily used for loading flash and initial installation

```

Welcome to UltraMatrix

Hit space bar within 5 seconds to get serial options menu

Power on diagnostics
Kernel version  KX14
Overlay version  031R
Kernel program  Good
Static ram      Good
Configuration   Good
Board number    2
Communication ID 6
Communication   Good
Local ports    16

Serial options menu

1) Change starting computer number ... 1
2) Change the serial port baud rate ... 9600
3) Receive new main program or kernel from serial port (this card only)
4) Send this unit's main program to other units
5) Send this unit's kernel to other units
6) Reset configuration data to factory default (this card only)
7) Save changes made in 1 and 2 (this card only)
8) Exit (restart the unit)

Enter choice -->

```

To set unit's address if no KVM in slot 1, can be saved with item 7

To set baud rate of serial port, can be saved with item 7
Much faster to use 57600 when loading new flash

To load new flash program or kernel from serial port
Use file copy from dos or send text file from Hyperterminal

To copy flash program or kernel to other boxes
Will display total of boards to update and prompt
Are you sure ? Y/N

Reset to factory default, resets this card only
Other cards must be reset with save configuration from main configuration menu

To save items 1 and 2 only

Exits serial option menu and restarts box