

# Orion FX

Enterprise KVM Switch • CATx or Fiber • 8 – 160 Ports

## Installation and Operation Manual



ROSE.COM

# LIMITED WARRANTY

---

---

Rose Electronics warrants the Orion™ FX to be in good working order for one year from the date of purchase from Rose Electronics or an authorized dealer. Should this product fail to be in good working order at any time during this one-year warranty period, Rose Electronics will, at its option, repair or replace the Unit as set forth below. Repair parts and replacement units will be either reconditioned or new. All replaced parts become the property of Rose Electronics. This limited warranty does not include service to repair damage to the Unit resulting from accident, disaster, abuse, or unauthorized modification of the Unit, including static discharge and power surges.

Limited Warranty service may be obtained by delivering this unit during the one-year warranty period to Rose Electronics or an authorized repair center providing a proof of purchase date. If this Unit is delivered by mail, you agree to insure the Unit or assume the risk of loss or damage in transit, to prepay shipping charges to the warranty service location, and to use the original shipping container or its equivalent. You must call for a return authorization number first. Under no circumstances will a unit be accepted without a return authorization number. Contact an authorized repair center or Rose Electronics for further information.

ALL EXPRESS AND IMPLIED WARRANTIES FOR THIS PRODUCT INCLUDING THE WARRANTIES OF MERCHANTABILITY AND FITNESS FOR A PARTICULAR PURPOSE, ARE LIMITED IN DURATION TO A PERIOD OF ONE YEAR FROM THE DATE OF PURCHASE, AND NO WARRANTIES, WHETHER EXPRESS OR IMPLIED, WILL APPLY AFTER THIS PERIOD. SOME STATES DO NOT ALLOW LIMITATIONS ON HOW LONG AN IMPLIED WARRANTY LASTS, SO THE ABOVE LIMITATION MAY NOT APPLY TO YOU.

IF THIS PRODUCT IS NOT IN GOOD WORKING ORDER AS WARRANTED ABOVE, YOUR SOLE REMEDY SHALL BE REPLACEMENT OR REPAIR AS PROVIDED ABOVE. IN NO EVENT WILL ROSE ELECTRONICS BE LIABLE TO YOU FOR ANY DAMAGES INCLUDING ANY LOST PROFITS, LOST SAVINGS OR OTHER INCIDENTAL OR CONSEQUENTIAL DAMAGES ARISING OUT OF THE USE OF OR THE INABILITY TO USE SUCH PRODUCT, EVEN IF ROSE ELECTRONICS OR AN AUTHORIZED DEALER HAS BEEN ADVISED OF THE POSSIBILITY OF SUCH DAMAGES, OR FOR ANY CLAIM BY ANY OTHER PARTY.

SOME STATES DO NOT ALLOW THE EXCLUSION OR LIMITATION OF INCIDENTAL OR CONSEQUENTIAL DAMAGES FOR CONSUMER PRODUCTS, SO THE ABOVE MAY NOT APPLY TO YOU. THIS WARRANTY GIVES YOU SPECIFIC LEGAL RIGHTS AND YOU MAY ALSO HAVE OTHER RIGHTS WHICH MAY VARY FROM STATE TO STATE.

Copyright Rose Electronics 2026. All rights reserved.

No part of this manual may be reproduced, stored in a retrieval system, or transcribed in any form or any means, electronic or mechanical, including photocopying and recording, without the prior written permission of Rose Electronics.

# DECLARATIONS OF CONFORMITY

---

This is to certify that Orion FX Series as delivered complies with the 2014/30/EU Council Directive on the approximation of the laws of the Member States relating to electromagnetic compatibility, and with the 2014/35/EU Council Directive on the harmonization of the laws of the Member States relating to the making available on the market of electrical equipment designed for use within certain voltage limits., as well as these standards:

- EN 55032:2015 + AC:2016 + A11:2020 + A1:2020
- EN 55035:2017/A11:2020
- EN IEC 61000-3-2:2019
- EN 61000-3-3:2013 + A1:2019 + A2:2021 + A2:2021/AC:2022
- EN 61000-6-2:2019
- EN 62368-1:2020 + A11:2020
- EN IEC 63000:2018

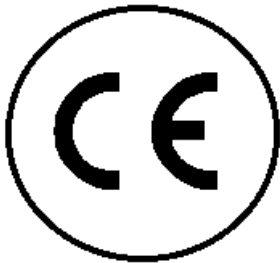

This equipment has been found to comply with the limits for a Class A digital device, pursuant to Part 15 of the FCC Rules. These limits are designed to provide reasonable protection against harmful interference when the equipment is operated in a commercial environment. This equipment generates, uses, and can radiate radio frequency energy and, if not installed and used in accordance with the instruction manual, may cause harmful interference to radio communications. Operation of this equipment in a residential area is likely to cause harmful interference in which case the user will be required to correct the interference at their own expense.

The product safety of the devices is proven by their compliance to the EN 62368-1:2020 + A11:2020 standard.

The manufacturer complies with the EU Directive 2012/19/EU on the prevention of waste electrical and electronic equipment (WEEE). The device labels carry a respective marking.

These devices comply with Directive EN 63000:2018 on the restriction of the use of certain hazardous substances in electrical and electronic equipment

# TABLE OF CONTENTS

---

---

## Contents

Disclaimer	1
Introduction	1
Features	2
Compatibility	3
Package contents	3
Orion FX Model Description	4
Orion FX 8-Port Models	4
Orion FX 16-Port Models	5
Orion FX 24-Port Models	6
Orion FX 32-Port Models	7
Orion FX 32-Port Models with Grid Ports	8
Orion FX 40-Port Models	9
Orion FX 48-Port Models	10
Orion FX 64-Port Models	11
Orion FX 64-Port Models (Continued)	12
Orion FX 80-Port Models	13
Orion FX 80-Port Models (Continued)	14
Orion FX 120-Port Models	15
Orion FX 120-Port Models (Continued)	16
Orion FX 128-Port Models	17
Orion FX 128-Port Models (Continued)	18
Orion FX 144-Port Models	19
Orion FX 144-Port Models (Continued)	20
Orion FX 160-Port Models	21
Orion FX 160-Port Models (Continued)	22
Orion FX 160-Port Models (Continued)	23
Orion FX 160-Port Models (Continued)	24
Orion FX 160-Port Models (Continued)	25
Installation	26
System Setup	26
Setup of the matrix	26
Setup of Extenders	26
Possible Orion FX Setups	27
KVM Matrix	27
Parallel Operation (Stacking)	28
Matrix Grid	29

Configuration	30
Command Mode	30
Set user-defined 'Hot Key'	31
Set 'Hot Key' for direct OSD access	31
Reset 'Hot Key'	31
Control Options	32
Control through the OSD	32
Entering the OSD	32
Leaving the OSD	32
Menu Structure	33
OSD Keyboard controls	34
Sorting Functions	34
Password request	35
Control through the Java Tool	37
Requirements	37
Installation of the Java Tool	37
Computer Connection to the Matrix	37
Starting the Java Tool	37
Connecting to the Orion X	38
Java Tool Menu Structure	39
Operating Instructions	40
Mouse Controls in the Java Tool	40
Keyboard Controls in the Java Tool	40
Reload Options	40
Context Function	41
Sorting Function	41
Filter Function	41
Offline Configuration	41
Online Configuration	42
Setting Java Tool Options	43
Report	47
Configuring System Settings	48
System Settings	48
Modifying System Settings through the OSD	50
Modifying System Settings through the Java Tool	51
Automatic ID	52
Modifying Automatic ID Settings through the OSD	52
Modifying Automatic ID Settings through the Java Tool	53

Global OSD Settings	54
Modifying Global Hot Key and Fast Key Settings through the OSD	54
Modifying Global Hot Key and Fast Key Settings through the Java Tool	55
Access Control	56
Modifying Access Control through the OSD	57
Modifying Access Control through the Java Tool	58
Switch Settings	59
Modifying Switch Settings through the OSD	60
Modifying Switch Settings through the Java Tool	61
Network Configuration	62
Network Ports Used by Orion FX	63
Modifying Network Settings through the OSD	64
Modifying Network Configuration through the Java Tool	65
Active Directory	68
Configuration of Active Directory Server Synchronization with the OSD	69
Configuration of Active Directory Server Synchronization with the Java Tool	71
SNMP	74
SNMP Configuration with the OSD	74
SNMP Configuration with the Java Tool	76
Date and Time	78
Modifying Date and Time Settings through the OSD	79
Modifying Date and Time Settings through the Java Tool	80
Configuring User Settings	81
User	81
Modifying User Settings through the OSD	82
Modifying User Settings through the Java Tool	84
User Favorites List	87
Setting up User Favorites through the OSD	87
Setting up User Favorites through the Java Tool	89
User Macros	90
Setting up User Macros through the OSD	91
Setting up User Macros through the Java Tool	92
User Groups	96
Setting up User Groups through the OSD	96
Setting up User Groups through the Java Tool	98
Configuring Extender Settings	99
Managing Extender Settings through the OSD	100
Managing Extender Settings through the Java Tool	101

Flex-Port Extender Units	101
USB 2.0 Extender	102
Configuring USB 2.0 Extenders through the OSD	102
Configuring USB 2.0 Extenders through the Java Tool	104
Configuring CPU Settings	106
CPU Device Settings	106
Modifying CPU Device Settings through the OSD	107
Modifying CPU Device Settings with the Java Tool	108
CPU Groups	111
Creating and Modifying CPU Groups with the OSD	111
Creating and Modifying CPU Groups with the Java Tool	112
Configuration of a CPU Switch	114
Configuring a CPU Switch with the OSD	114
Virtual CPU	116
Assignment of Virtual CPUs through the OSD	116
Assignment of Virtual CPUs through Java Tool	117
Configuring Console Settings	119
Console Device Settings	119
Setting up CON Devices through the OSD	121
Setting up CON Devices through the Java Tool	122
OSD Mouse and Keyboard Configuration	125
Modifying OSD Mouse and Keyboard Settings with the OSD	126
Modifying OSD Mouse and Keyboard Settings through the Java Tool	127
Console Extender OSD Settings	128
Modifying Console Extender OSD Settings through the OSD	129
Modifying Console Extender OSD Settings through the Java Tool	130
Console Favorites List	131
Setting up Console Favorites through the OSD	131
Setting up Console Favorites with the Java Tool	132
Console Macros	133
Setting up Console Macros through the OSD	134
Setting up Console Macros through the Java Tool	135
Virtual Console	138
Assignment of Virtual Consoles through the OSD	138
Assignment of Virtual Consoles through Java Tool	139
Shared Operation	140
Setting up Shared Operation with the OSD	141
Setting up Shared Operation with the Java Tool	142

Multi-Screen Control	143
Configuring Multi-Screen Control through the OSD (for Single-Head Applications)	143
Configuring Multi-Screen Control with the Java Tool	146
Extended Configuration for Multi-Head Multi-Screen Control with the Java Tool	149
Saving and Loading of Configurations	150
Saving the Current Configuration to the Orion FX	150
Saving the Configuration in a specific internal location	152
Saving the Configuration to a Specific Storage using the OSD	152
Saving the Configuration to a Specific Location using the Java Tool	153
Loading Configurations from Internal Memory	154
Loading a Configuration from Internal Memory with the OSD	154
Loading a Configuration from Internal Memory with the Java Tool	155
Saving of Configurations (External)	156
Loading of Configurations (external)	157
Export and Import Options	159
Export Options	159
Import Options	160
Matrix Cascading	161
Setting Up Matrix Cascading through the OSD	161
Setting Up Matrix Cascading through the Java Tool	163
Matrix Grid	165
Administration of Settings	165
General Preparation	165
Setting Up a Matrix Grid through the OSD	166
Setting Up a Matrix Grid through the Java Tool	168
Firmware Update	170
Matrix Update	170
Preparation	170
Performing the Update	171
Extender Update	174
Preparation	174
Performing the Update in Standard Mode (Parallel Update)	175
Performing the Update in Expert Mode (sequential Update)	178
Operation	180
Switching Operation via Keyboard Commands	180
Direct Switching	180
Direct Switching of Video, Keyboard and Mouse	180
Direct Switching of Video, Keyboard and Mouse in Private Mode	180

Direct Switching of Video Only	181
Direct Switching of Video, Keyboard and Mouse to previous CPU	181
Disconnect current connection	181
Scan Mode	181
Function Keys <F1>-<F16>	181
Switching a CON Unit to a local Source	182
Multi-Screen Control	182
Switching through the mouse	182
Switching through the keyboard	182
Switching Operation through the OSD	183
KVM Switching	183
Switching using the Selection List for CPU Devices	185
Activating automatic Scan Mode for CPU Devices	185
Extended Switching	186
USB 2.0 Switching	187
Switching a CON Unit to a Local Source with the OSD	188
Switching via Macro List	189
Switching Single EXT Units within Devices through the OSD	190
Addressing of Master and Sub Matrices	191
Switching Operation through the Java Tool	192
Extended Switching	192
Predefining Macros	196
Redundancy	198
Monitoring Redundancy Status with the OSD	198
Monitoring Redundancy Status with the Java Tool	199
Power Up and Power Down Functions	200
Restart	200
Restarting Through the OSD	200
Restarting through the Java Tool	200
Factory Reset	200
Resetting Through the OSD	200
Resetting Through the Java Tool	200
Power Down	201
Power Down through the OSD	201
Power Down through the Java Tool	201
Summary of Keyboard Commands	202
Extender Commands	202
Matrix Commands	203

Diagnostics and Status	204
LED Indicators	204
Device Status LEDs	204
Port Link Status LEDs, CATx 1G	205
Port Link Status LEDs, CATx 3G	205
Port Link Status LEDs, Fiber	206
Network Connection Link and Activity Status LEDs	207
Power Supply Status LEDs	207
Port Status	208
Viewing Port Status with the Java Tool	208
Port Status Matrix Grid	211
Extender OSD	212
Network Status	213
Viewing Network Status through the OSD	213
Viewing Network Status with the Java Tool	214
Matrix Firmware Status	214
Firmware Status through the OSD	215
Firmware Status through the Java Tool	216
Extender Firmware Status	217
Extender Firmware on I/O Board Status	220
Trace Function	221
Syslog Monitoring	222
Filter Function	223
Recording Function	223
Syslog Find Function	224
System Check	225
Repair	227
Technical Support	227
Safety	228
Safety and EMC Regulatory Statements	229
Troubleshooting	230
External Failure	230
Video Interference	230
Fan Malfunction	230
Power Supply Unit Malfunction	230
Network Error	231
Failure at the matrix	231
Port Interconnect Failure	231

Error Indication at the 1G CATx port	231
Error Indication at the 3G CATx Port	232
Error Indication at the Fiber Port	232
Blank Screen	233

## Figures

Figure 1. Front Panel, 8-Port Model with all CATx Ports	4
Figure 2. Front Panel, 8-Port Model with All Fiber Ports	4
Figure 3. Front Panel, 16-Port Model with all CATx Ports	5
Figure 4. Front Panel, 16-Port Model with All Fiber Ports	5
Figure 5. Rear Panel, 16-Port Models	5
Figure 6. Front Panel, 24-Port Model with all CATx Ports	6
Figure 7. Front Panel, 24-Port Model with All Fiber Ports	6
Figure 8. Rear Panel, 24-Port Models	6
Figure 9. Front Panel, 32-Port Model with all CATx Ports	7
Figure 10. Front Panel, 32-Port Model with All Fiber Ports	7
Figure 11. Rear Panel, 32-Port Models	7
Figure 12. Front Panel, 32-Port Model with Grid Port and all CATx Ports	8
Figure 13. Front Panel, 32-Port Model with Grid Port and all Fiber Ports	8
Figure 14. Rear Panel, 32-Port Models with Grid Port	8
Figure 15. Front Panel, 40-Port Model with all CATx Ports	9
Figure 16. Front Panel, 40-Port Model with all Fiber Ports	9
Figure 17. Front Panel, 40-Port Model with 24 CATx and 16 Fiber Ports	9
Figure 18. Rear Panel, 40-Port Models	9
Figure 19. Front Panel, 48-port Model with All CATx Ports	10
Figure 20. Front Panel, 48-Port Model with All Fiber Ports	10
Figure 21. Rear Panel, 48-Port Models	10
Figure 22. Front Panel, 64-Port Model with All CATx Ports	11
Figure 23. Front Panel, 64-Port Model with All Fiber Ports	11
Figure 24. Front Panel, 64-Port Model with 40 Fiber Ports and 24 CATx Ports	11
Figure 25. Front Panel, 64-Port Model with 40 CATx Ports and 24 Fiber Ports	11
Figure 26. Rear Panel, 64-Port Models	12
Figure 27. Front Panel, 80-Port Model with all CATx Ports	13
Figure 28. Front Panel, 80-Port Model with all Fiber Ports	13
Figure 29. Front Panel, 80-Port Model with 40 CATx Ports and 40 Fiber Ports	13
Figure 30. Rear Panel, 80-Port Models	14
Figure 31. Front Panel, 120-Port Model with All CATx Ports	15
Figure 32. Front Panel, 120-Port Model with All Fiber Ports	15
Figure 33. Front Panel, 120-Port Model with 80 CATx Ports and 40 Fiber Ports	16
Figure 34. Rear Panel, 120-Port Models	16
Figure 35. Front Panel, 128-Port Model with All CATx Ports	17
Figure 36. Front Panel, 128-Port Model with All Fiber Ports	17
Figure 37. Rear Panel, 128-Port Models	18

Figure 38. Front Panel, 144-Port Model with All CATx Ports	19
Figure 39. Front Panel, 144-Port Model with All Fiber Ports	19
Figure 40. Rear Panel, 144-Port Models	20
Figure 41. Front Panel, 160-Port Model with All CATx Ports	21
Figure 42. Front Panel, 160-Port Model with All Fiber Ports	22
Figure 43. Front Panel, 160-Port Model with 120 CATx Ports and 40 Fiber Ports	23
Figure 44. Front Panel, 160-Port Model with 80 CATx Ports and 80 Fiber Ports	24
Figure 45. Rear Panel, 160-Port Models	25
Figure 46. Single-head KVM Matrix	27
Figure 47. Parallel Operation (Stacking)	28
Figure 48. Matrix Grid	29
Figure 49. OSD Main Menu	33
Figure 50. Configuration Login Screen in the OSD	35
Figure 51. Configuration Menu in the OSD	36
Figure 52. Java Tool Device Connect	38
Figure 53. Device Finder in the Java Tool	38
Figure 54. System Settings - System Screen in the Java Tool	39
Figure 55. Java Tool Online Configuration	42
Figure 56. Default Settings Tab in the Java Tool Options Menu	43
Figure 57. Java Tool Font Size, Tool Tips and Color Theme	44
Figure 58. Java Tool Language and Character Set	45
Figure 59. Java Tool Miscellaneous Options Menu	46
Figure 60. Java Tool Configuration Report	47
Figure 61. Modifying System Settings through the OSD	50
Figure 62. Modifying System Settings through the Java Tool	51
Figure 63. Modifying Automatic ID Settings through the OSD	52
Figure 64. Modifying Automatic ID Settings through the Java Tool	53
Figure 65. Global Hot Key and Fast Key settings in the OSD	54
Figure 66. Global Hot Key and Fast Key Settings in the Java Tool	55
Figure 67. Modifying Access Control through the OSD	57
Figure 68. Modifying Access Control through the Java Tool	58
Figure 69. Modifying Switch Settings through the OSD	60
Figure 70. Modifying Switch Settings through the Java Tool	61
Figure 71. Modifying Network Settings through the OSD	64
Figure 72. Modifying Network Settings through the Java Tool	65
Figure 73. Syslog Activation	66
Figure 74. Syslog Options Tab in the Java Tool	67
Figure 75. Network Settings for Active Directory with the OSD	69

Figure 76. Active Directory Configuration with the OSD	70
Figure 77. Active Directory Setup with the Java Tool	71
Figure 78. Creating a User for Active Directory with the Java Tool	72
Figure 79. Create an LDAP User in the Java Tool	72
Figure 80. Create a new LDAP Group with the Java Tool	73
Figure 81. SNMP Monitoring through the OSD	74
Figure 82. SNMP Monitoring through the Java Tool	76
Figure 83. Setting SNMP Options in the Java Tool	77
Figure 84. Add SNMP User in the Java Tool	77
Figure 85. Modifying Date and Time Settings through the OSD	79
Figure 86. Modifying Date and Time Settings through the Java Tool	80
Figure 87. Modifying User Settings through the OSD	82
Figure 88. Modifying User Settings through the Java Tool	84
Figure 89. Choosing a User Type in the Java Tool	85
Figure 90. New User Password Assignment in the Java Tool	85
Figure 91. Assigning New User Access Rights in the Java Tool	86
Figure 92. OSD Main Menu	87
Figure 93. User Favorites OSD menu	88
Figure 94. Setting up a User Favorites List with the Java Tool	89
Figure 95. Setting Up User Macros through the OSD	91
Figure 96. Setting Up User Macros through the Java Tool	92
Figure 97. User Macros Function Key selection with Java Tool	93
Figure 98. User Macro Function Selection with Java Tool	94
Figure 99. User Macro Parameter Selection with Java Tool	95
Figure 100. User Groups Settings in the OSD	96
Figure 101. Setting up User Groups with the Java Tool	98
Figure 102. Select New Group type in the Java Tool	98
Figure 103. Managing Extender Settings through the OSD	100
Figure 104. Managing Extender Settings through the Java Tool	101
Figure 105. Configuring USB 2.0 Extenders through the OSD	102
Figure 106. Configuring USB 2.0 Extenders through the Java Tool	104
Figure 107. New Extender Unit Type Selection in the Java Tool	104
Figure 108. Activate Fixed USB Port Dialog	105
Figure 109. Modifying CPU Device Settings through the OSD	107
Figure 110. Modifying CPU Device Settings with the Java Tool	108
Figure 111. New CPU Device Dialog in the Java Tool	110
Figure 112. Creating and Modifying CPU Groups with the Java Tool	112
Figure 113. CPU Group Template Pop-Up Menu in the Java Tool	113

Figure 114. Configuring a 484 Series Switch with the OSD	114
Figure 115. Virtual CPU Device Assignment through the OSD	116
Figure 116. Virtual CPU Devices Assignment through Java Tool	117
Figure 117. Open CPU device in Assignment Virtual CPU Menu	118
Figure 118. Setting Up CON Devices through the OSD	121
Figure 119. Setting Up CON Devices through the Java Tool	122
Figure 120. New CON Device Type	123
Figure 121. Assign CON Device Access Rights by Right Click	124
Figure 122. Modifying OSD Mouse and Keyboard Settings through the OSD	126
Figure 123. Modifying Mouse and Keyboard Settings through the Java Tool	127
Figure 124. Modifying Extender OSD Settings through the OSD	129
Figure 125. Modifying Extender OSD Settings through the Java Tool	130
Figure 126. Setting up Console Favorites through the OSD	131
Figure 127. Setting Up Console Favorites through the Java Tool	132
Figure 128. Setting Up Console Macros through the OSD	134
Figure 129. Setting up Console Macros through the Java Tool	135
Figure 130. Assign Settings Menu in the Java Tool	136
Figure 131. Select CON Device to Receive Assigned Settings in the Java Tool	137
Figure 132. Virtual CON Devices Assignment through the OSD	138
Figure 133. Virtual to Real Console Assignment through Java Tool	139
Figure 134. Enabling Shared Operation with the OSD	141
Figure 135. Enabling Shared Operation with the Java Tool	142
Figure 136. Setting Up Multi-Screen Control with the OSD	144
Figure 137. Setting Up Multi-Screen Control with the Java Tool	146
Figure 138. Multi-Head Multi-Screen Configuration with the Java Tool	149
Figure 139. Configuration Save in the OSD	150
Figure 140. Remote Save in the Java Tool	151
Figure 141. Remote Save Configuration Prompt in the Java Tool	151
Figure 142. Saving Configuration to Internal Storage Locations with the OSD	152
Figure 143. Saving Configuration to Internal Storage with the Java Tool	153
Figure 144. Select a Configuration Internal Storage Location with the Java Tool	153
Figure 145. Loading Internal Configuration through the OSD	154
Figure 146. Loading Internal Configuration through the Java Tool	155
Figure 147. Prompt to Activate Loaded Configuration	155
Figure 148. Saving External Configuration through the Java Tool	156
Figure 149. Loading external configuration through the Java Tool	157
Figure 150. File Upload of Externally Saved Configuration in the Java Tool	158
Figure 151. Selecting a Slot to Store the Externally Saved Configuration in the Java Tool	158

Figure 152. Completed Loading of Externally Stored Configuration in the Java Tool	158
Figure 153. Exporting Configuration Lists in the Java Tool	159
Figure 154. Configuration List File Name and Storage Location in the Java Tool	159
Figure 155. Importing a Configuration List in the Java Too	160
Figure 156. Importing Configuration Lists through the Java Tool	160
Figure 157. Setting Up Matrix Cascading Through the OSD	161
Figure 158. Setting Up Matrix Cascading Through the Java Tool	163
Figure 159. Creating New Cascade Units with the Java Tool	163
Figure 160. Setting Up a Matrix Grid through the OSD - Step 1	166
Figure 161. Setting Up a Matrix Grid through the OSD - Step 2	167
Figure 162. Setting Up a Matrix Grid through the Java Tool	168
Figure 163. Matrix Grid Wizard in the Java Tool, Step 1	169
Figure 164. Matrix Grid Wizard in the Java Tool, Step 2	169
Figure 165. Additional Firmware Update Selection Options	171
Figure 166. Update Matrix Firmware in the Java Tool	171
Figure 167. Save Matrix Status Prompt	172
Figure 168. Firmware Update Progress Indicator	172
Figure 169. Prompt to Restart the Matrix After Firmware Update	173
Figure 170. Firmware Update Success	173
Figure 171. Firmware Directory in the Java Tool	174
Figure 172. Extender Update in Standard Mode through the Java Tool - Step 1: Upload Firmware	175
Figure 173. Upload Extender Firmware to I/O boards with Java Tool	176
Figure 174. Extender Firmware Update Part 2 in the Java Tool	176
Figure 175. Enable Downgrade to Reload Current or Previous Firmware with the Java Tool	177
Figure 176. Extender Update in Sequential Mode – Step 1 (from the Java Tool)	178
Figure 177. Activate Service Mode with the Java Tool	179
Figure 178. OSD View Service Mode – Step 2 (from the Service Mode of the OSD)	179
Figure 179. Main Menu of the OSD	183
Figure 180. KVM Switching Through the OSD	184
Figure 181. CPU Selection List in the OSD for KVM Switching	185
Figure 182. Extended KVM Switching through the OSD	186
Figure 183. CON Switching Through the OSD	188
Figure 184. Switching via Macro List in the OSD	189
Figure 185. Switching of Single Extenders within Devices in the OSD	190
Figure 186. Extended KVM Switching through Java Tool - Method 1 (From Extended Switch)	192
Figure 187. Full Access Selection List in the Java Tool	193
Figure 188. Extended KVM Switching through Java Tool - Method 2 (From View Matrix)	195
Figure 189. Setting up Macro Presets in the Java Tool	196

Figure 190. New Preset Macro Query	196
Figure 191. Selecting the Preset Switching Operation	197
Figure 192. Checking Redundant Links with the OSD	198
Figure 193. Checking Redundant Links with the Java Tool	199
Figure 194. Device Status LED 1 and LED 2	204
Figure 195. I/O Port Link Status Indicators, 1G CATx	205
Figure 196. I/O Port Link Status Indicators, 3G CATx	205
Figure 197. I/O Board Port Link Status Indicators, Fiber	206
Figure 198. Network Connection Link and Activity Status LEDs	207
Figure 199. Power Supply Status Indicators	207
Figure 200. Viewing Port Status with the Java Tool	208
Figure 201. Port Status Mouse Context Menu	210
Figure 202. View Port Status Matrix Grid	211
Figure 203. Extender OSD	212
Figure 204. Network Status in the OSD	213
Figure 205. Viewing Network Status through the Java Tool	214
Figure 206. Firmware Status through the OSD	215
Figure 207. Viewing Firmware Status through the Java Tool	216
Figure 208. Save Status Location and File Name in the Java Tool	216
Figure 209. Save Status Anonymous Option in the Java Tool	217
Figure 210. Save Status Steps in the Java Tool	217
Figure 211. Extender Firmware Status in the Java Tool	218
Figure 212. Expanded Firmware Status of Extender with the Java Tool	219
Figure 213. Extender Firmware on I/O Board Status	220
Figure 214. Trace Log Monitoring in the OSD	221
Figure 215. Syslog Monitoring with the Java Tool	222
Figure 216. Syslog Find Function	224
Figure 217. System Check with the Java Tool	225
Figure 218. Troubleshooting a 1G CATx Port Error	231
Figure 219. Troubleshooting a 3G CATx Port Error	232
Figure 220. Troubleshooting a Fiber Port Error	232
Figure 221. Troubleshooting Blank Screen	233
Figure 222. RJ45 Network Connector	235
Figure 223. I/O Board RJ45 Connector	235
Figure 224. I/O Port Fiber Type LC Connector	235

## Tables

Table 1. Compatible Devices	3
Table 2. Basic Keyboard Commands	30
Table 3. Keyboard Commands - Hot Key Codes	30
Table 4. Standard OSD Keyboard Commands	33
Table 5. Keyboard Controls in the OSD	34
Table 6. OSD Sorting Functions	34
Table 7. Default Login Settings	35
Table 8. Mouse Controls in the Java Tool	40
Table 9. Keyboard Controls in the Java Tool	40
Table 10. Java Tool Sorting Functions	41
Table 11. Java Tool Filter Functions	41
Table 12. Java Tool Options	43
Table 13. Java Tool Miscellaneous Options	46
Table 14. System Data in the OSD	49
Table 15. Buttons in the OSD System Screen	50
Table 16. Automatic ID Settings	52
Table 17. Buttons in the OSD System Screen	52
Table 18. Global OSD Settings	54
Table 19. OSD Save / Reject Selection Options	55
Table 20. Access Control Settings	57
Table 21. Buttons in OSD Configuration Access Screen	57
Table 22. Switch Settings	59
Table 23. Buttons in OSD Switch Settings Screen	60
Table 24. Network Settings	63
Table 25. Orion FX Network Ports	63
Table 26. Buttons in the OSD Network Settings Screen	64
Table 27. Java Tool Syslog Settings	66
Table 28. Syslog Options	67
Table 29. Active Directory Parameters	68
Table 30. Available SNMP Traps	75
Table 31. Date and Time Settings	78
Table 32. User Settings	81
Table 33. Buttons in the OSD User Settings Screen	82
Table 34. Buttons in the Java Tool User Settings Screen	84
Table 35. User Macro Settings	90
Table 36. General Extender Settings	99
Table 37. Buttons in the OSD Extender Settings Screen	100

Table 38. Buttons in the Java Tool Extender Settings Screen	101
Table 39. CPU Device Settings	106
Table 40. Buttons in the CPU Device Settings Screen	107
Table 41. Buttons in the Java Tools CU Device Settings Screen	109
Table 42. Keyboard Commands in the Java Tool CPU Device Settings Screen	109
Table 43. CPU Group Settings	111
Table 44. Some Buttons in the CPU Device Settings Screen	111
Table 45. CPU Group Settings	114
Table 46. Some Buttons in the CPU Device Settings Screen	115
Table 47. CON Device Settings	120
Table 48. Buttons in the Java Tool CON Devices Screen	122
Table 49. Keyboard Commands in the Java Tool CON Devices Screen	123
Table 50. Keyboard Commands for CPU Access Assignment in Java Tool in CON Devices Menu	124
Table 51. Mouse and Keyboard Settings	125
Table 52. Buttons in the Console Extender OSD Mouse and Keyboard Settings Screen	126
Table 53. Extender OSD Settings	128
Table 54. Console Macro Settings	133
Table 55. Java Tool Virtual CON Assignment Screen Buttons	139
Table 56. Multi-Screen Parameters in the OSD	143
Table 57. Setting Up Multi-Screen Control with the Java Tool	146
Table 58. Firmware Update Options in the Java Tool	170
Table 59. Additional Selection Options in the Update firmware menu	170
Table 60. Keyboard Commands for Local Source Switching	182
Table 61. Keyboard Commands for Multi-Screen Switching	182
Table 62. Keyboard Commands for Connecting and Disconnecting in the OSD	185
Table 63. Extended KVM Switch Settings in the OSD	187
Table 64. Description of Connection Symbols in the Java Tool Extended Switch Screen	194
Table 65. Buttons in the Java Tool Extended Switching Screen	194
Table 66. Extender Keyboard Commands	202
Table 67. Matrix Keyboard Commands	203
Table 68. Device Status Indicators	204
Table 69. CATx 1G Link Status Indicators	205
Table 70. CATx 3G Link Status Indicators	205
Table 71. Fiber Link Status Indicators	206
Table 72. Network Connection Link and Activity Status Indicators	207
Table 73. Front Panel Power Supply Indicators	207
Table 74. Color Indicators in the Java Tool Port Status Screen	208
Table 75. Symbols in the Java Tool Port Status Screen	209

Table 76. Extender Information for a Port in the Java Tool Port Status Screen	209
Table 77. Mouse Context Menu for a Port in the Java Tool Port Status Screen	210
Table 78. Information Displayed in the Extender OSD Screen	212
Table 79. Network Status Settings	213
Table 80. Information Displayed in the Matrix Firmware Status Screen	214
Table 81. Information Displayed in the Extender Firmware Status Screen	217
Table 82. Extender Firmware Update Indicators in the Java Tool	219
Table 83. Information Displayed in the Extender Firmware on I/O Board Status Screen	220
Table 84. Information Displayed in Trace Function	221
Table 85. Filter Options for Syslog Monitoring	223
Table 86. System Check Notification Levels	226
Table 87. Troubleshooting an External Failure	230
Table 88. Troubleshooting Video Interference	230
Table 89. Troubleshooting a Fan Malfunction	230
Table 90. Troubleshooting a Power Supply Unit Malfunction	230
Table 91. Troubleshooting a Network Error	231
Table 92. Troubleshooting a Failure at the Matrix	231
Table 93. Troubleshooting a 1G CATx Port Error	231
Table 94. Troubleshooting a 3G CATx Port Error	232
Table 95. Troubleshooting a Fiber Port Error	232
Table 96. Troubleshooting a Blank Screen	233
Table 102. Link Bandwidth and Distance	234
Table 103. RJ45 Network Connector Pinouts	235
Table 104. I/O Board RJ45 Connector Pinouts	235
Table 105. I/O Port Fiber Type LC Connector Pinouts	235
Table 106. Current and Voltage and Power Requirements for the Orion FX CATx 1G	236
Table 107. Current and Voltage and Power Requirements for the Orion FX CATx 3G	236
Table 108. Current and Voltage and Power Requirements for the Orion FX CATx 3G	237
Table 109. Current and Voltage and Power Requirements for the Orion FX Mixed Port Models 1G	237
Table 110. Current and Voltage and Power Requirements for the Orion FX Mixed Port Models 3G	237
Table 111. Environmental Conditions Requirements for the Orion X	238
Table 112. MTBF Values for the Orion FX	238
Table 113. Size of the 4U Orion FX model and its Shipping Box	239
Table 114. Size of the 2U Orion FX model and its Shipping Box	239
Table 115. Size of the 1U Orion FX model and its Shipping Box	239
Table 116. Size of the 8-Port Orion FX model and its Shipping Box	239
Table 117. Shipping Weight of the 4U Orion FX	239
Table 118. Shipping Weight of the 2U Orion FX	239

<u>Table 119. Shipping Weight of the 1U Orion FX</u>	<u>239</u>
<u>Table 120. Shipping Weight of the 8-Port Orion FX</u>	<u>239</u>
<u>Table 121. Part Numbers for Orion FX Units with CATx 1G Ports</u>	<u>240</u>
<u>Table 122. Part Numbers for Orion FX Units with CATx 3GPorts</u>	<u>240</u>
<u>Table 123. Part Numbers for Orion FX Units with Fiber Single Mode 1G Ports</u>	<u>241</u>
<u>Table 124. Part Numbers for Orion FX Units with Fiber Multi Mode 1G Ports</u>	<u>241</u>
<u>Table 125. Part Numbers for Orion FX Units with Fiber Single Mode 3G Ports</u>	<u>242</u>
<u>Table 126. Part Numbers for Orion FX Units with Mixed CATx and Fiber 1G Ports</u>	<u>242</u>
<u>Table 127. Part Numbers for Orion FX Units with Mixed CATx and Fiber 3G Ports</u>	<u>242</u>
<u>Table 128. Part Numbers for Orion FX Units Matrix Grid Version with 1G Ports</u>	<u>242</u>
<u>Table 129. Part Numbers for Orion FX Units with Expansion Capability in a 2U Chassis</u>	<u>243</u>
<u>Table 130. Part Numbers for Orion FX Units with Expansion Capability in a 4U Chassis</u>	<u>243</u>

## Appendices

Appendix A - General Specifications	234
Link Bandwidth and Distance	234
Connector Pinouts	235
RJ45 Connector (Network)	235
RJ45 Connector (Interconnect)	235
Fiber SFP Type LC Connector	235
Maximum Current, Voltage, and Power Consumption	236
Orion FX, CATx 1G	236
Orion FX, CATx 3G	236
Orion FX, Fiber 1G and 3G	237
Orion FX Mixed Port Models 1G	237
Orion FX Mixed Port Models 3G	237
Environmental Conditions	238
MTBF	238
Dimensions	239
Orion FX 120-port, 128-port, 144-port, and 160-port (4U)	239
Orion FX 48-port, 64-port, and 80-port models (2U)	239
Orion FX 16-port, 24-port, 32-port, and 40-port models (1U)	239
Orion FX 8-port models (1U Half-Width)	239
Weight	239
Orion FX 120-port, 128-port, 144-port, and 160-port (4U)	239
Orion FX 48-port, 64-port, and 80-port models (2U)	239
Orion FX 16-port, 24-port, 32-port, and 40-port models (1U)	239
Orion FX 8-port models (1U Half-Width)	239
Appendix B - Part numbers	240

# INTRODUCTION

---

---

## Disclaimer

---

While every precaution has been taken in the preparation of this manual, the manufacturer assumes no responsibility for errors or omissions. Neither does the manufacturer assume any liability for damages resulting from the use of the information contained herein. The manufacturer reserves the right to change the specifications, functions, circuitry of the product, and manual content at any time without notice.

The manufacturer cannot accept liability for damages due to misuse of the product or other circumstances outside the manufacturer's control. The manufacturer will not be responsible for any loss, damage, or injury arising directly or indirectly from the use of this product. (See limited warranty.)

## Introduction

---

Thank you for choosing the Rose Electronics Orion™ FX System. The Orion FX System is the result of Rose Electronics' commitment to providing continued state-of-the-art switching solutions for today's demanding workplace. The Orion FX System has proven to be a valuable investment for all types of businesses that have the need to monitor, maintain, route, switch and access information from multiple computer systems. Its use in large computer and multimedia facilities gives the IT professional the added flexibility to monitor and maintain several systems, running on different platforms, from multiple KVM stations. The Orion FX System is the common-sense solution that provides the flexibility and security required for today's business environment.

Rose Electronics' Orion FX System is designed to be configured to meet system demands - one user or multiple users, two computers or hundreds. All configurations offer standard features that allow for easy, secure, and complete access to as many computers as the system has, from multiple KVM user stations. The Orion FX unit is connected to the computers and user stations through CATx cables, single-mode fiber cables or multi-mode fiber cables. Using CATx cabling, the distance can be up to 460 feet (140m) on either side of the matrix. The distance can be up to 3,280 feet (1 km) using multi-mode fiber, or 32,808 feet (10 km) using single-mode Fiber. The use of lower bulk cables makes installation easier, quicker, and less expensive.

The Orion FX is available in models which can support from 8 up to 160 independent ports, each of which functions independently. Each port can be defined and switched either as a console or a CPU port. The ports can be all CATx or all Fiber, or a combination of the two. It is designed to operate with extenders that can transmit keyboard, video, mouse, USB 2.0 signals. It can also be used as a video only matrix.

The convenient On-Screen Display (OSD) menus are intuitive and easy to use. They guide the user through the process of configuring the Orion FX.

The Orion FX is used along with extender Transmitters (CPU devices), and Receivers (CON devices). The CPU devices connect to the computer or video source, and the CON devices connect to DVI, HDMI or DisplayPort displays, as well as USB keyboards and USB mice. The CPU and CON devices connect to the Orion FX using CATx or Fiber cables. CPU and CON device models vary depending on the device support required.

The reliability, security, and versatility of the Orion FX streamline any data center or server room by simplifying maintenance, access, and updating.

**Note:** This is a Class A product. In a domestic environment, this product may cause radio interference, in which case the user may be required to take adequate measures to correct the interference at their own expense. The safety instructions and installation guidelines in this manual should be considered carefully. Compliance with the specifications for cable lengths and types is essential.

## Features

---

- Comes in a variety of models, each with different numbers of ports, from 8-port to 160-port
- Ports can be all CATx, all Fiber, or mixed CATx and Fiber
- Extend KVM stations and computers up to 460 feet (140m) on either side of the matrix through CATx cable, up to 3,280 feet (1 km) using multi-mode fiber, or 32,808 feet (10 km) using single-mode fiber
- Supports resolutions up to 1920 x 1200 @ 60Hz
- Intuitive OSD for easy use and configuration at each user station
- Each port on the Orion FX will automatically be configured as an input or output depending on the type of device that is connected. If a CPU device is connected, the port becomes an input. If a CON device is connected, the port becomes an output.
- Switch between video sources of the same resolution instantly
- Handles a variety of signals including:
  - DVI-D, DVI-I(VGA), HDMI, DisplayPort inputs
  - USB 2.0, USB HID
  - PS/2
  - Analog and Digital audio
- Orion FX units can be cascaded or stacked to build larger systems
- Matrix grid configuration allows combining Orion FX units into larger systems with redundant connections
- Multi-screen control provides for configuring extenders with multiple displays so that they can be seamlessly blended to function as one display in a variety of configurations
- Redundant power connections
- Rack-mountable:
  - 8-port, 16-port, 24-port, 32-port, and 40-port models are 1U size
  - 48-port, 64-port, and 80-port models are 2U size
  - 120-port, 128-port, 144-port, and 160-port are 4U size

## Compatibility

---

Video	DVI-I (VGA or DVI), HDMI, DisplayPort
Keyboards	Compatible with all standard USB keyboards. Keyboards with a built-in hub are also supported maximum of two HID devices supported
Mouse	Compatible with all standard USB 2-button, 3-button and wheel mice
Audio	Supports analog and digital audio
USB	Supports USB 2.0 devices
Interconnect	<ul style="list-style-type: none"><li>■ CATx cable allows a maximum distance of 460 ft (140 m) on either side of the switch.</li><li>■ Single-mode fiber cable allows up to 32,800 ft (10 km) on either side of the switch.</li><li>■ Multi-mode fiber cable allows up to 3,280 ft (1 km) on either side of the switch.</li></ul>

**Table 1. Compatible Devices**

Contact Rose Electronics for PS/2 keyboard and mouse support options

## Package contents

---

- Orion FX unit as ordered
- 1 x power cord for each AC power connector
- Rack mount kit with screws (optional)
- 1 x CATx network crossover cable (optional)
- Java Tool Software
- Manual

# MODELS

## Orion FX Model Description

The Orion FX is available in models with 8, 16, 24, 32, 40, 48, 64, 80, 120, 128, 144, and 160 ports. These models are available with all CATx ports, all fiber ports, and mixed CATx and fiber ports.

### Orion FX 8-Port Models

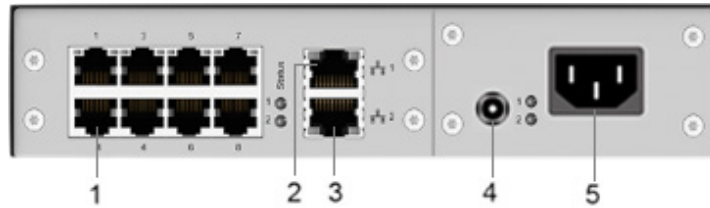

Figure 1. Front Panel, 8-Port Model with all CATx Ports

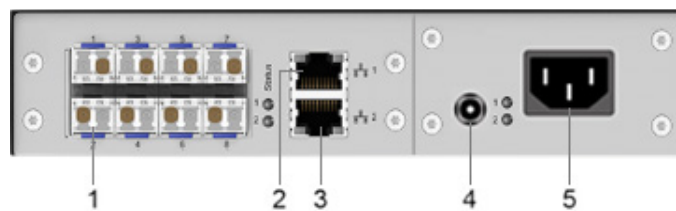

Figure 2. Front Panel, 8-Port Model with All Fiber Ports

- |                           |   |
|---------------------------|---|
| 1 – I/O Ports 1 through 8 | 4 – DC Power supply connector (redundant) |
| 2 – Network port 1 (RJ45) | 5 – AC Power supply connector (standard)  |
| 3 – Network port 2 (RJ45) |   |

# Orion FX 16-Port Models

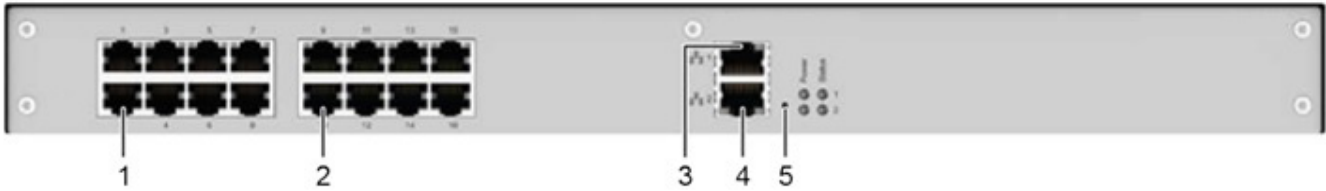

Figure 3. Front Panel, 16-Port Model with all CATx Ports

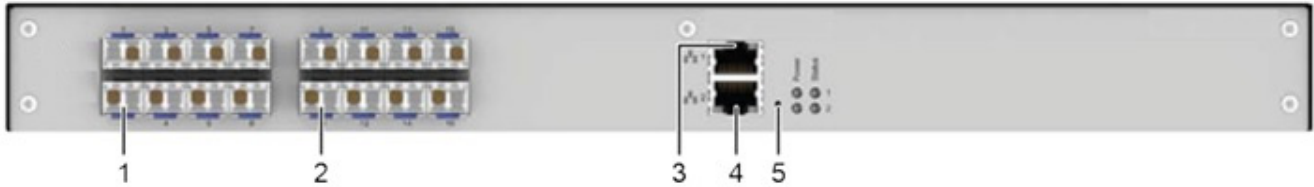

Figure 4. Front Panel, 16-Port Model with All Fiber Ports

- 1 – I/O Ports 1 through 8
- 2 – I/O Ports 9 through 16
- 3 – Network port 1 (RJ45)
- 4 – Network port 2 (RJ45)
- 5 – Reset button



Figure 5. Rear Panel, 16-Port Models

- 1 – Power supply connector (standard)
- 2 – Power supply connector (redundant)
- 3 – Grounding

## Orion FX 24-Port Models

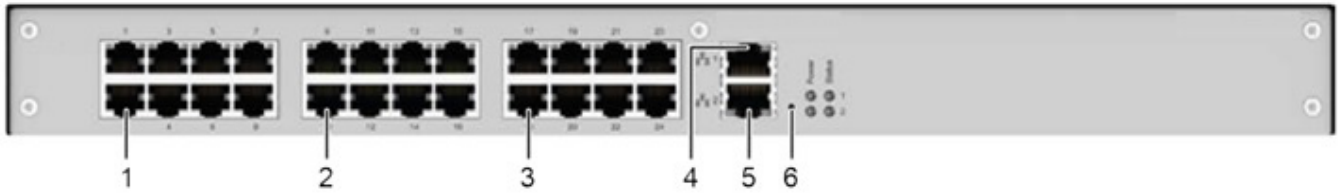

Figure 6. Front Panel, 24-Port Model with all CATx Ports

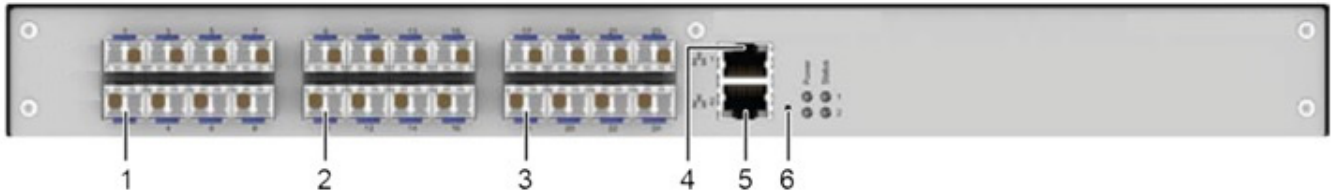

Figure 7. Front Panel, 24-Port Model with All Fiber Ports

- |                             |                           |
|-----------------------------|---------------------------|
| 1 - I/O Ports 1 through 8   | 4 - Network Port 1 (RJ45) |
| 2 - I/O Ports 9 through 16  | 5 - Network port 2 (RJ45) |
| 3 - I/O Ports 17 through 24 | 6 - Reset button          |



Figure 8. Rear Panel, 24-Port Models

- |  |               |
|--|---------------|
| 1 - Power supply connector (standard)  | 3 - Grounding |
| 2 - Power supply connector (redundant) |               |

## Orion FX 32-Port Models

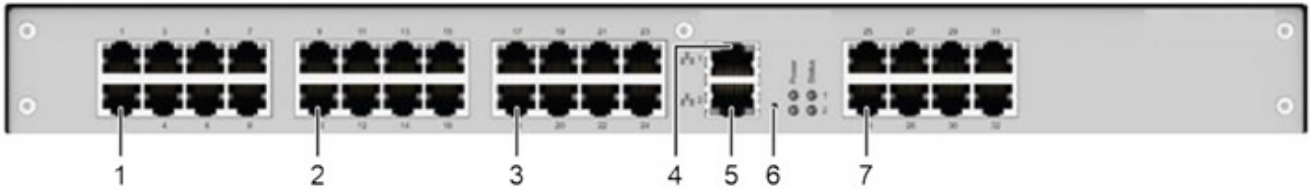

Figure 9. Front Panel, 32-Port Model with all CATx Ports

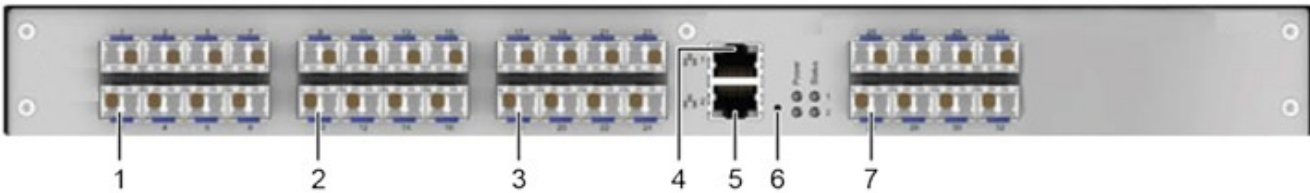

Figure 10. Front Panel, 32-Port Model with All Fiber Ports

- |                             |                             |
|-----------------------------|-----------------------------|
| 1 – I/O Ports 1 through 8   | 5 – Network Port 2 (RJ45)   |
| 2 – I/O Ports 9 through 16  | 6 – Reset button            |
| 3 – I/O Ports 17 through 24 | 7 – I/O Ports 25 through 32 |
| 4 – Network port 1 (RJ45)   |                             |



Figure 11. Rear Panel, 32-Port Models

- |  |               |
|--|---------------|
| 1 – Power supply connector (standard)  | 3 – Grounding |
| 2 – Power supply connector (redundant) |               |

## Orion FX 32-Port Models with Grid Ports

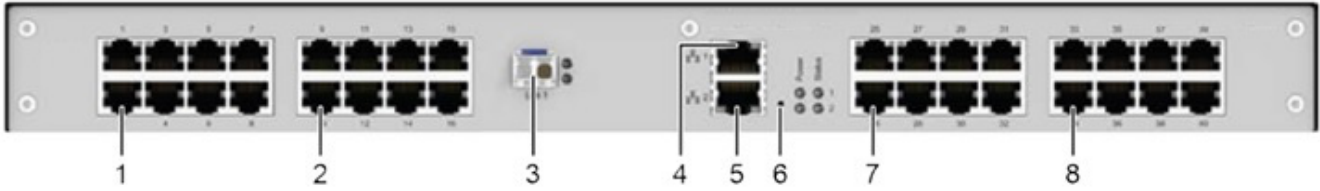

Figure 12. Front Panel, 32-Port Model with Grid Port and all CATx Ports

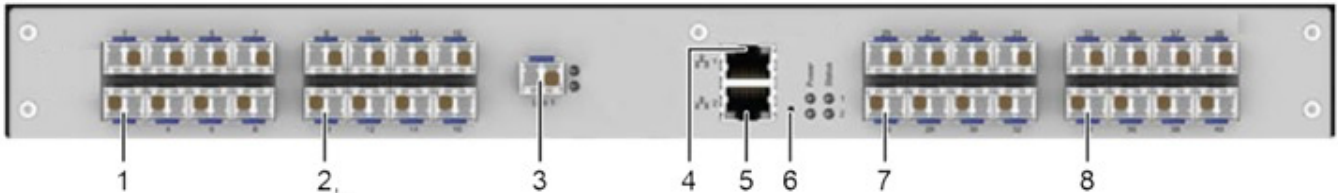

Figure 13. Front Panel, 32-Port Model with Grid Port and all Fiber Ports

- |                            |                             |
|----------------------------|-----------------------------|
| 1 – I/O Ports 1 through 8  | 5 – Network Port 2 (RJ45)   |
| 2 – I/O Ports 9 through 16 | 6 – Reset button            |
| 3 – Grid port 1            | 7 – I/O Ports 17 through 24 |
| 4 – Network port 1 (RJ45)  | 8 – I/O Ports 25 through 32 |



Figure 14. Rear Panel, 32-Port Models with Grid Port

- |  |               |
|--|---------------|
| 1 – Power supply connector (standard)  | 3 – Grounding |
| 2 – Power supply connector (redundant) |               |

## Orion FX 40-Port Models

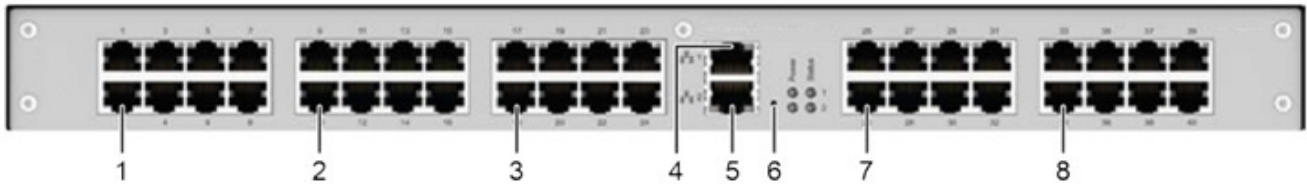

Figure 15. Front Panel, 40-Port Model with all CATx Ports

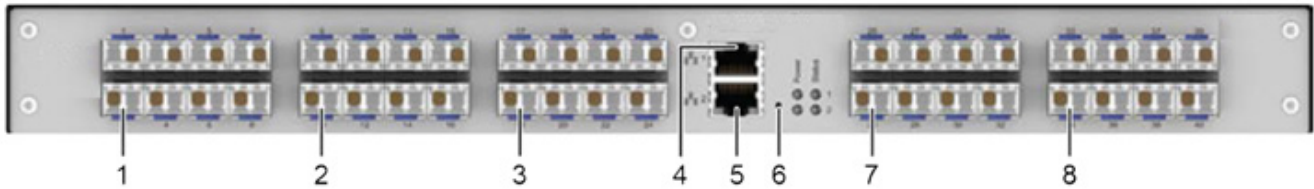

Figure 16. Front Panel, 40-Port Model with all Fiber Ports

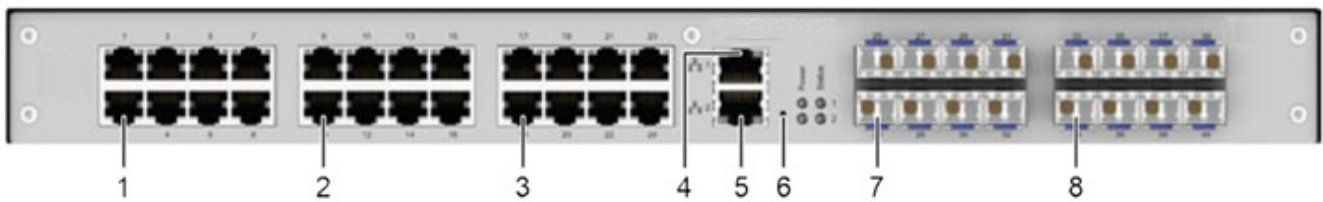

Figure 17. Front Panel, 40-Port Model with 24 CATx and 16 Fiber Ports

- |                             |                             |
|-----------------------------|-----------------------------|
| 1 – I/O Ports 1 through 8   | 5 – Network Port 2 (RJ45)   |
| 2 – I/O Ports 9 through 16  | 6 – Reset button            |
| 3 – I/O Ports 17 through 24 | 7 – I/O Ports 25 through 32 |
| 4 – Network port 1 (RJ45)   | 8 – I/O Ports 33 through 40 |



Figure 18. Rear Panel, 40-Port Models

- |  |               |
|--|---------------|
| 1 – Power supply connector (standard)  | 3 – Grounding |
| 2 – Power supply connector (redundant) |               |

## Orion FX 48-Port Models

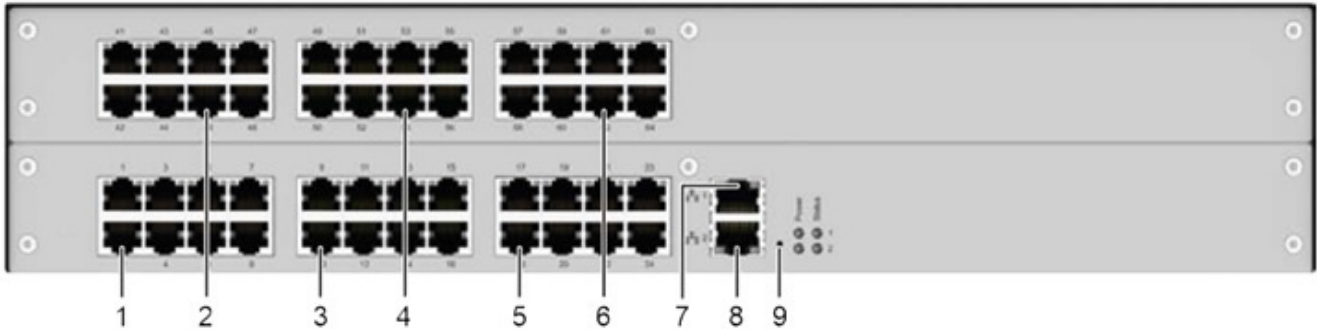

Figure 19. Front Panel, 48-port Model with All CATx Ports

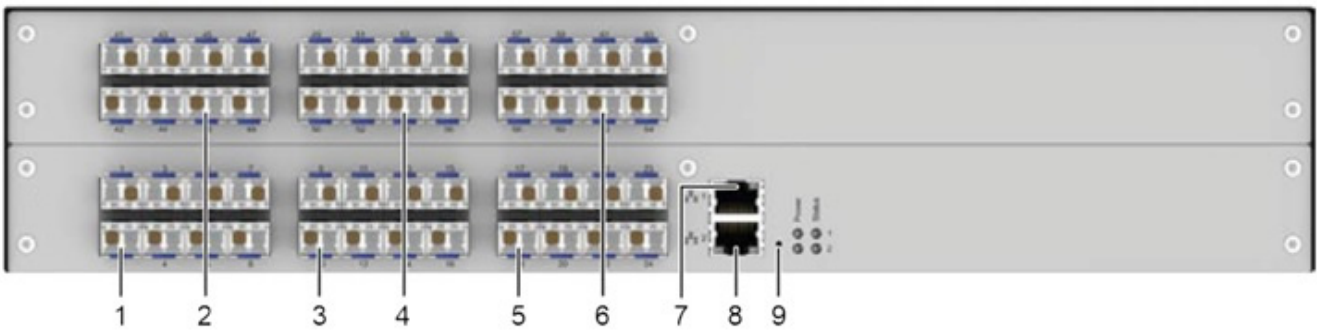

Figure 20. Front Panel, 48-Port Model with All Fiber Ports

- |                             |                             |
|-----------------------------|-----------------------------|
| 1 – I/O Ports 1 through 8   | 6 – I/O Ports 41 through 48 |
| 2 – I/O Ports 25 through 32 | 7 – Network Port 1 (RJ45)   |
| 3 – I/O Ports 9 through 16  | 8 – Network Port 2 (RJ45)   |
| 4 – I/O Ports 33 through 40 | 9 – Reset button            |
| 5 – I/O Ports 17 through 24 |                             |



Figure 21. Rear Panel, 48-Port Models

- |  |               |
|--|---------------|
| 1 – Power supply connector (standard)  | 3 – Grounding |
| 2 – Power supply connector (redundant) |               |

## Orion FX 64-Port Models

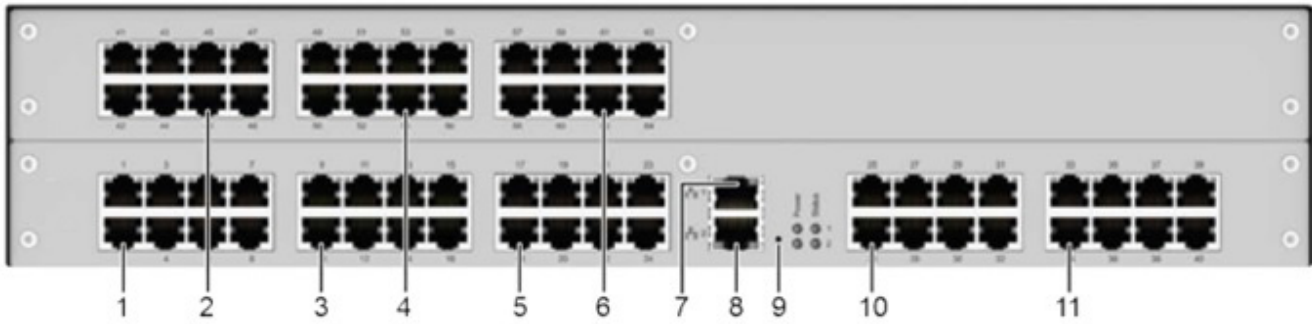

Figure 22. Front Panel, 64-Port Model with All CATx Ports

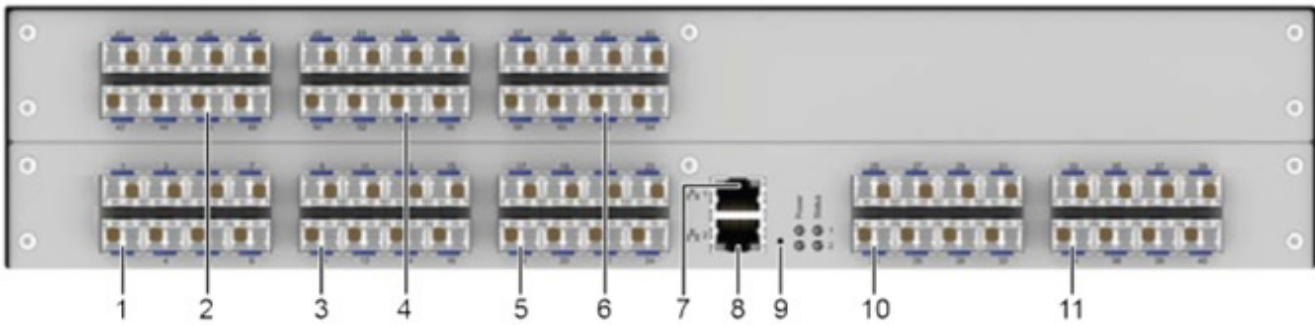

Figure 23. Front Panel, 64-Port Model with All Fiber Ports

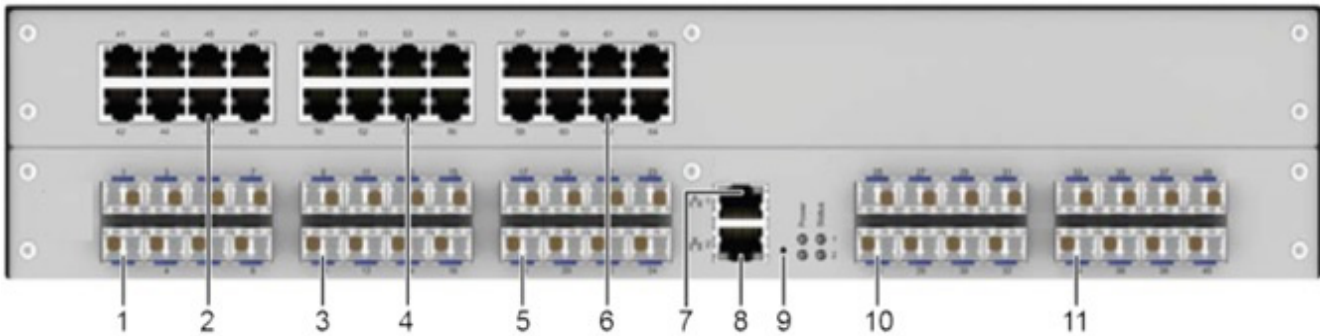

Figure 24. Front Panel, 64-Port Model with 40 Fiber Ports and 24 CATx Ports

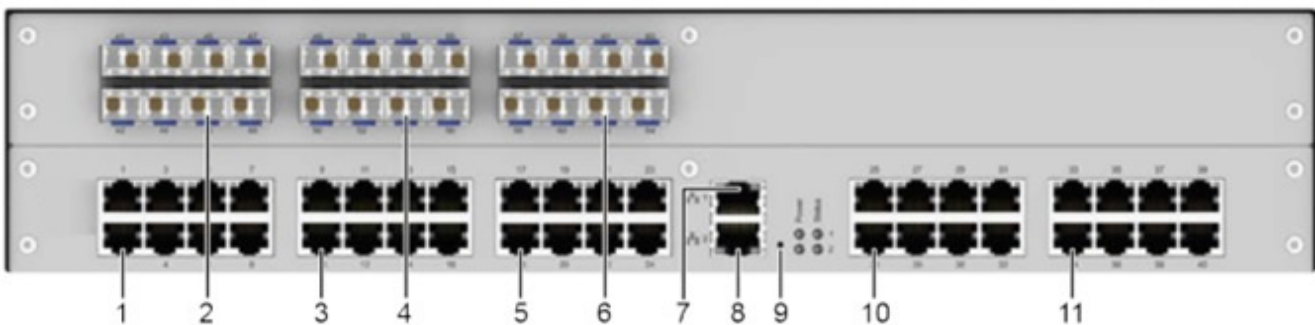

Figure 25. Front Panel, 64-Port Model with 40 CATx Ports and 24 Fiber Ports

- |                             |                              |
|-----------------------------|------------------------------|
| 1 – I/O Ports 1 through 8   | 7 – Network Port 1 (RJ45)    |
| 2 – I/O Ports 41 through 48 | 8 – Network Port 2 (RJ45)    |
| 3 – I/O Ports 9 through 16  | 9 – Reset button             |
| 4 – I/O Ports 49 through 56 | 10 – I/O Ports 25 through 32 |
| 5 – I/O Ports 17 through 24 | 11 – I/O Ports 33 through 40 |
| 6 – I/O Ports 57 through 64 |                              |

## Orion FX 64-Port Models (Continued)



**Figure 26. Rear Panel, 64-Port Models**

- 1 – Power supply connector (standard)
- 2 – Power supply connector (redundant)
- 3 – Grounding

## Orion FX 80-Port Models

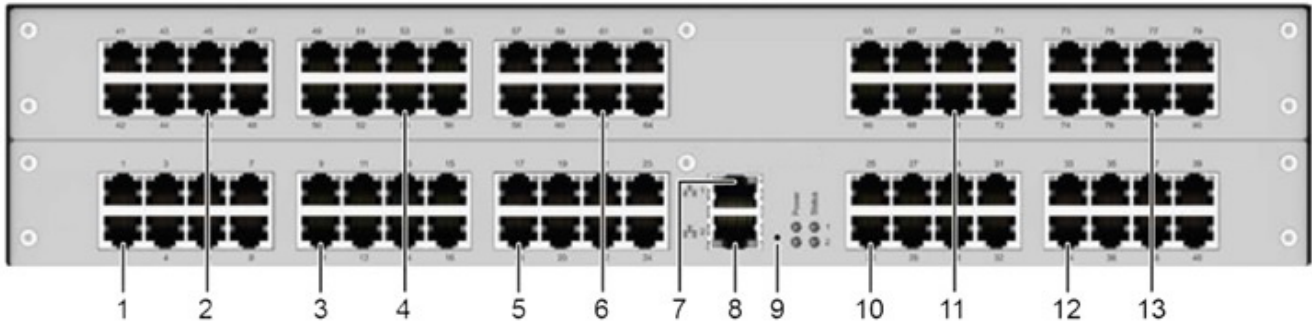

Figure 27. Front Panel, 80-Port Model with all CATx Ports

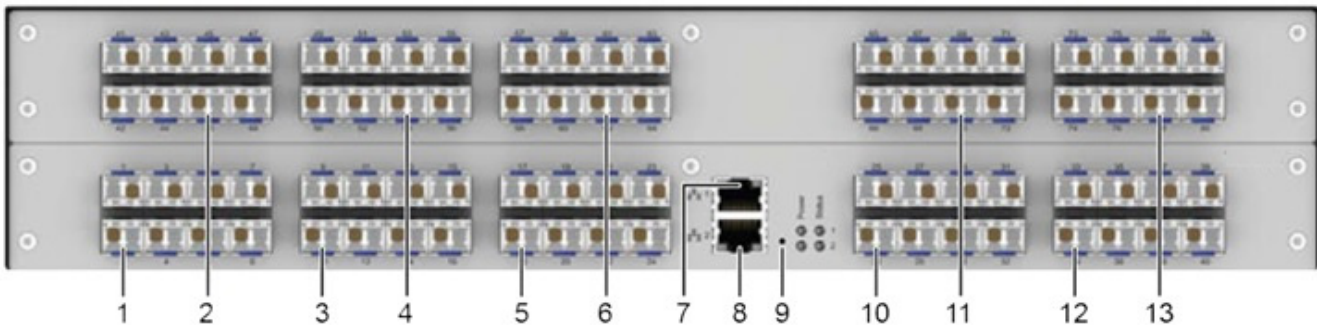

Figure 28. Front Panel, 80-Port Model with all Fiber Ports

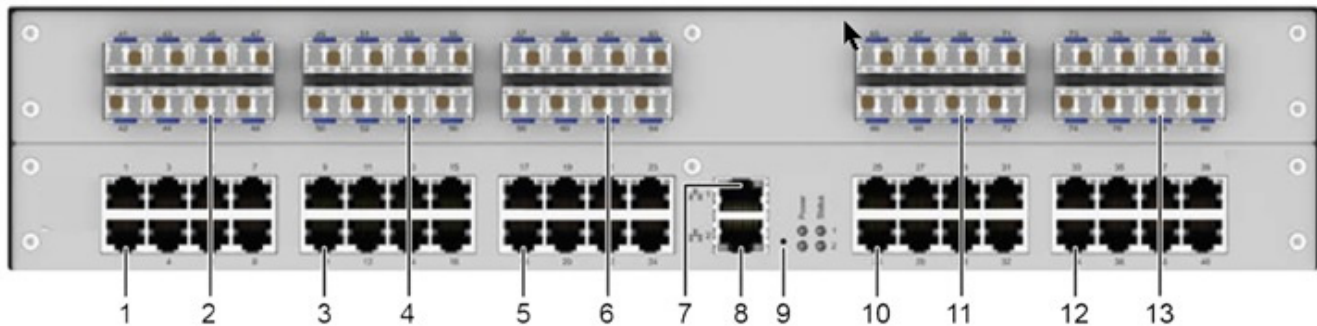

Figure 29. Front Panel, 80-Port Model with 40 CATx Ports and 40 Fiber Ports

- |                             |                             |
|-----------------------------|-----------------------------|
| 1 - I/O Ports 1 through 8   | 8 - Network Port 2 (RJ45)   |
| 2 - I/O Ports 41 through 48 | 9 - Reset button            |
| 3 - I/O Ports 9 through 16  | 10- I/O Ports 25 through 32 |
| 4 - I/O Ports 49 through 56 | 11- I/O Ports 65 through 72 |
| 5 - I/O Ports 17 through 24 | 12- I/O Ports 33 through 40 |
| 6 - I/O Ports 57 through 64 | 13- I/O Ports 73 through 80 |
| 7 - Network Port 1 (RJ45)   |                             |

## Orion FX 80-Port Models (Continued)



**Figure 30. Rear Panel, 80-Port Models**

- 1 – Power supply connector (standard)
- 2 – Power supply connector (redundant)
- 3 – Grounding

## Orion FX 120-Port Models

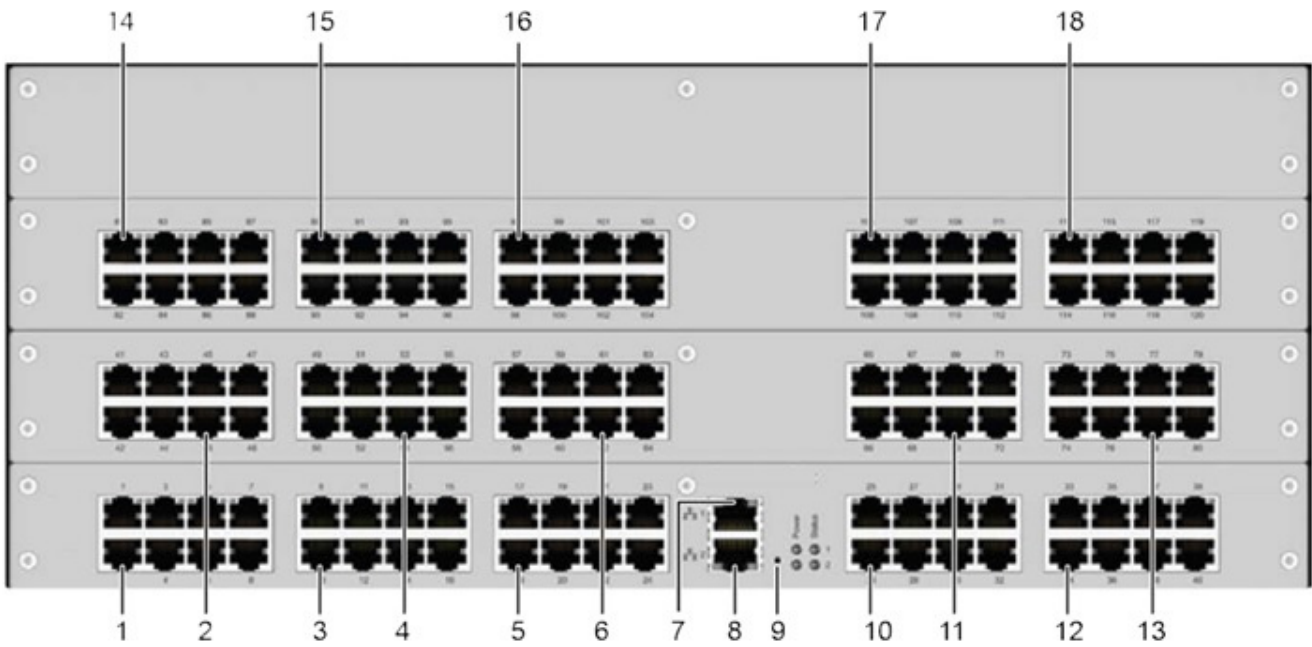

Figure 31. Front Panel, 120-Port Model with All CATx Ports

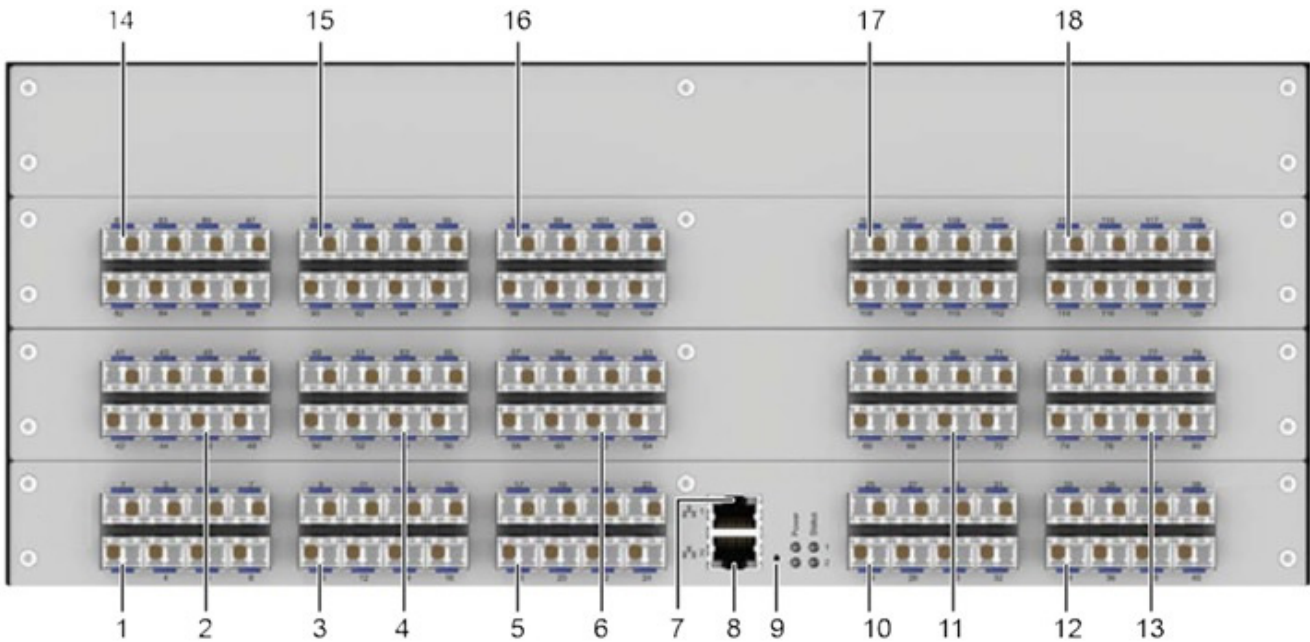
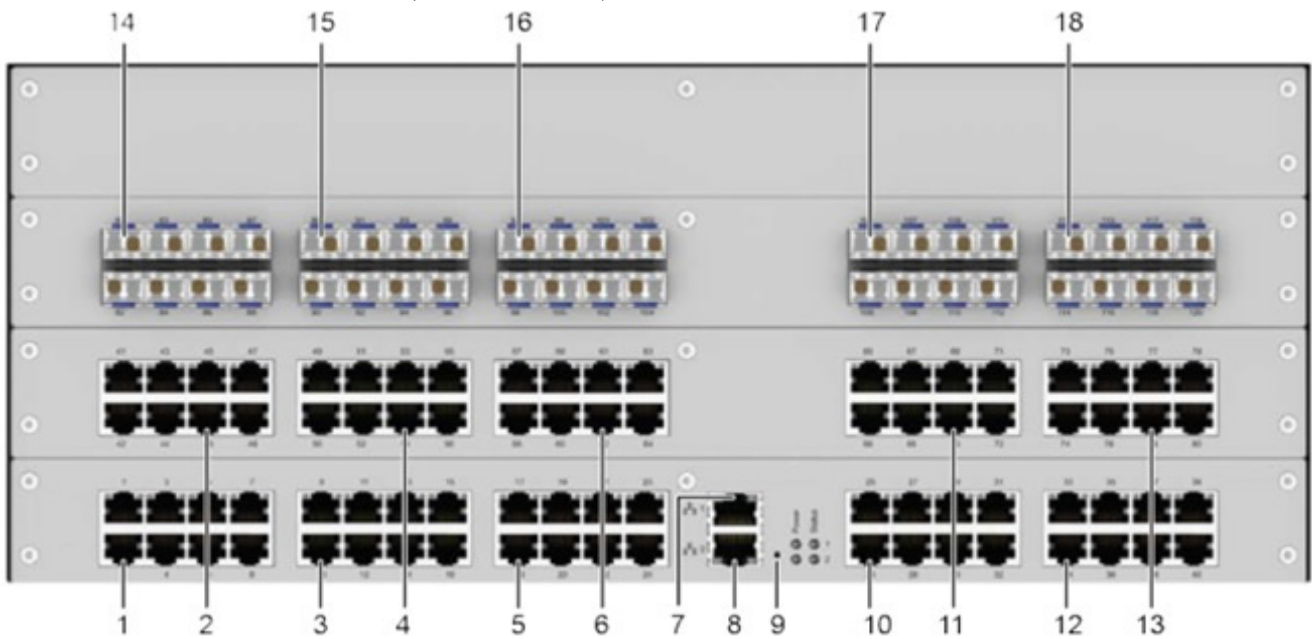

Figure 32. Front Panel, 120-Port Model with All Fiber Ports

## Orion FX 120-Port Models (Continued)



**Figure 33. Front Panel, 120-Port Model with 80 CATx Ports and 40 Fiber Ports**

- |                             |                                |
|-----------------------------|--------------------------------|
| 1 – I/O Ports 1 through 8   | 10 – I/O Ports 25 through 32   |
| 2 – I/O Ports 41 through 48 | 11 – I/O Ports 65 through 72   |
| 3 – I/O Ports 9 through 16  | 12 – I/O Ports 33 through 40   |
| 4 – I/O Ports 49 through 56 | 13 – I/O Ports 73 through 80   |
| 5 – I/O Ports 17 through 24 | 14 – I/O Ports 81 through 88   |
| 6 – I/O Ports 57 through 64 | 15 – I/O Ports 89 through 96   |
| 7 – Network Port 1 (RJ45)   | 16 – I/O Ports 97 through 104  |
| 8 – Network Port 2 (RJ45)   | 17 – I/O Ports 105 through 112 |
| 9 – Reset button            | 18 – I/O Ports 113 through 120 |

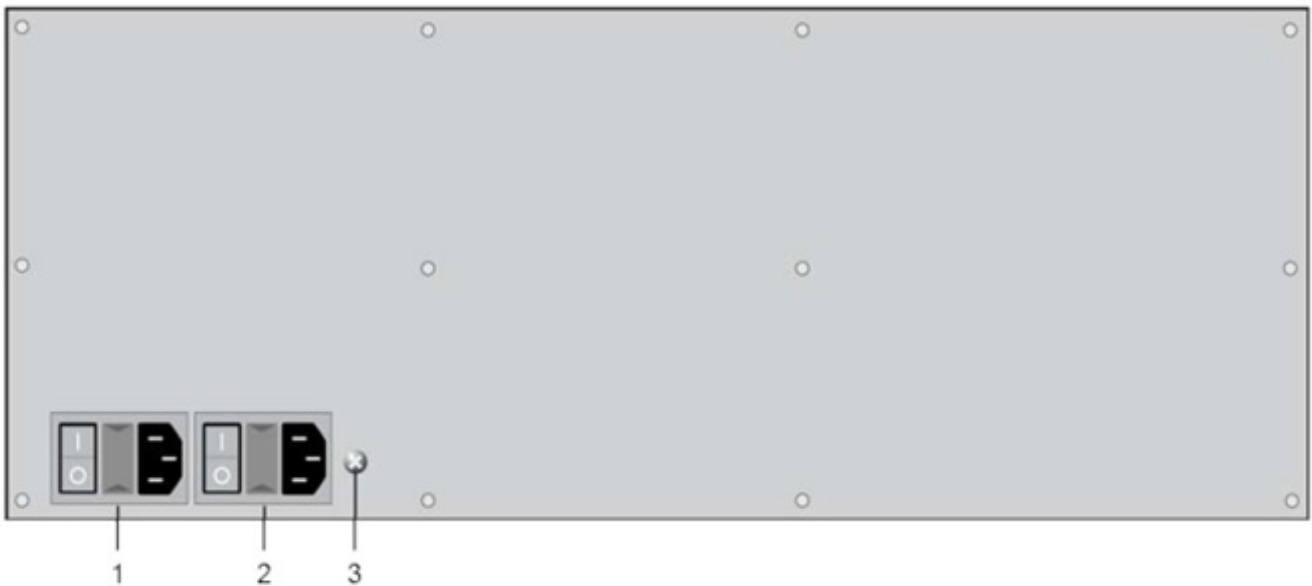

**Figure 34. Rear Panel, 120-Port Models**

- |  |               |
|--|---------------|
| 1 – Power supply connector (standard)  | 3 – Grounding |
| 2 – Power supply connector (redundant) |               |

## Orion FX 128-Port Models



Figure 35. Front Panel, 128-Port Model with All CATx Ports

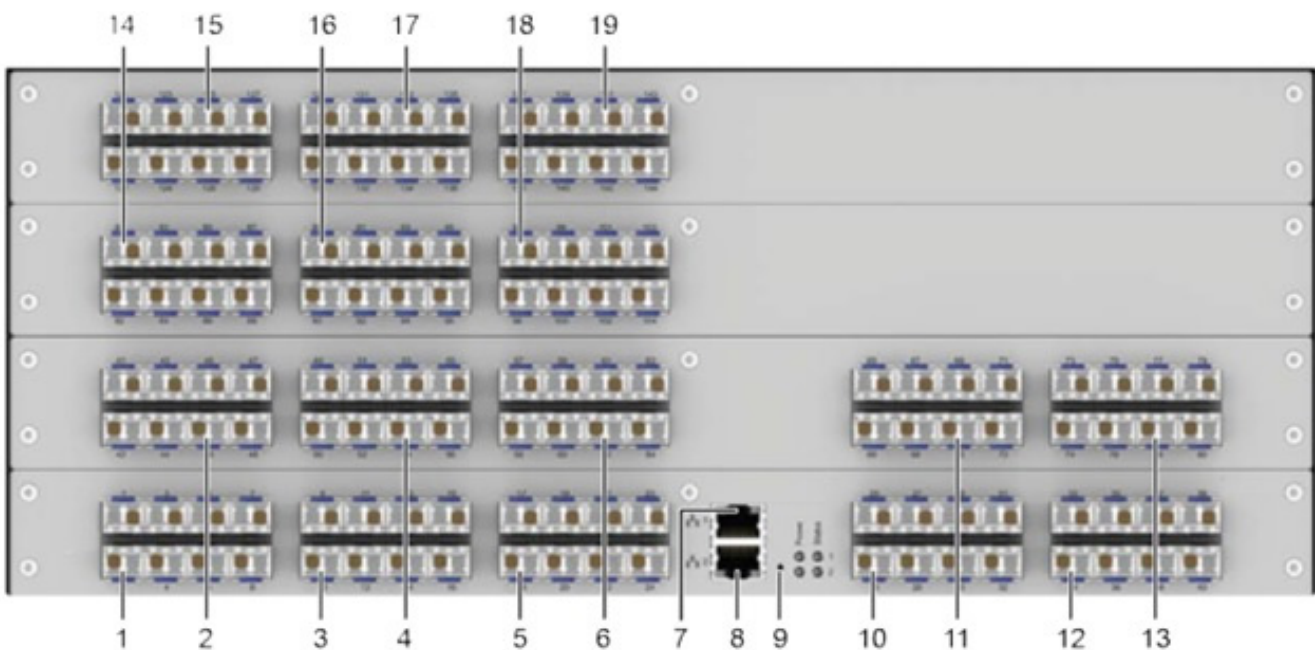
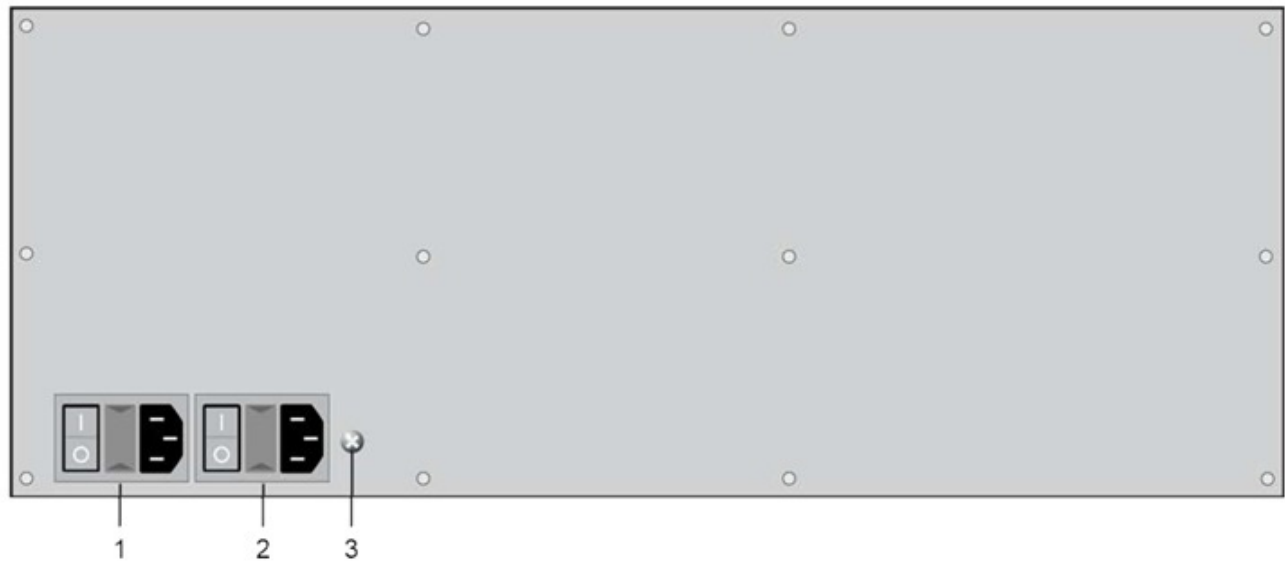

Figure 36. Front Panel, 128-Port Model with All Fiber Ports

- |                             |                                |
|-----------------------------|--------------------------------|
| 1 – I/O Ports 1 through 8   | 11 – I/O Ports 65 through 72   |
| 2 – I/O Ports 41 through 48 | 12 – I/O Ports 33 through 40   |
| 3 – I/O Ports 9 through 16  | 13 – I/O Ports 73 through 80   |
| 4 – I/O Ports 49 through 56 | 14 – I/O Ports 81 through 88   |
| 5 – I/O Ports 17 through 24 | 15 – I/O Ports 105 through 112 |
| 6 – I/O Ports 57 through 64 | 16 – I/O Ports 89 through 96   |
| 7 – Network Port 1 (RJ45)   | 17 – I/O Ports 113 through 120 |
| 8 – Network Port 2 (RJ45)   | 18 – I/O Ports 97 through 104  |
| 9 – Reset button            | 19 – I/O Ports 121 through 128 |
| 10 – I/O Ports 25 to 32     |                                |

## Orion FX 128-Port Models (Continued)



**Figure 37. Rear Panel, 128-Port Models**

- 1 – Power supply connector (standard)
- 2 – Power supply connector (redundant)
- 3 – Grounding

## Orion FX 144-Port Models



Figure 38. Front Panel, 144-Port Model with All CATx Ports

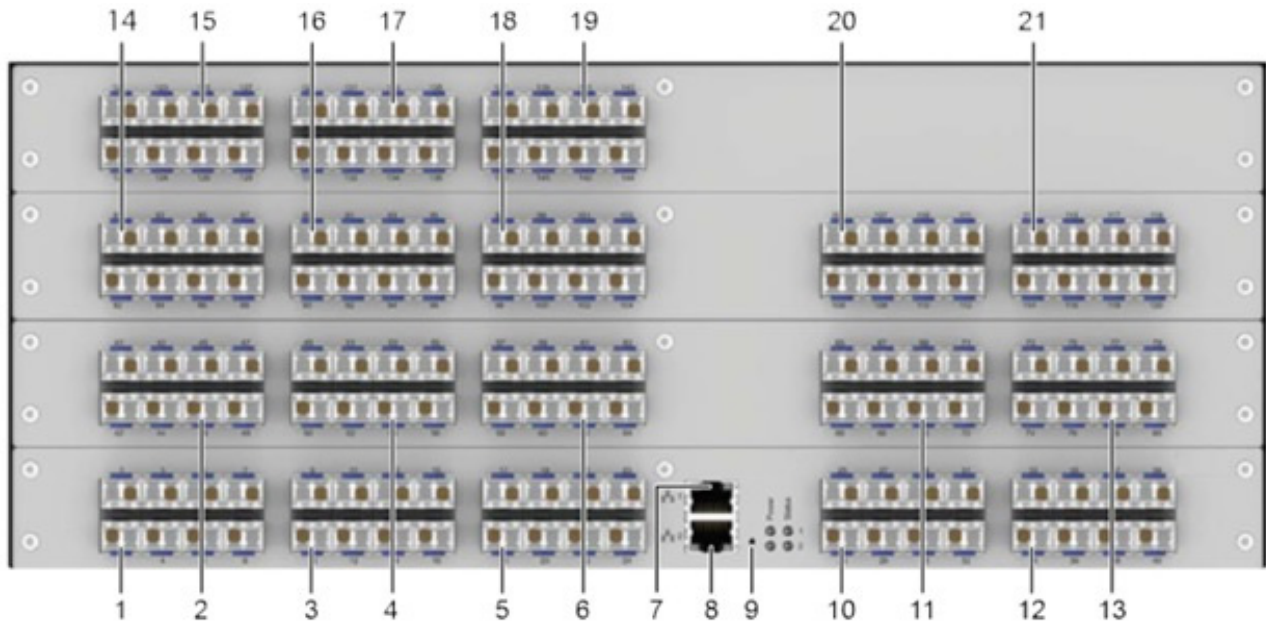
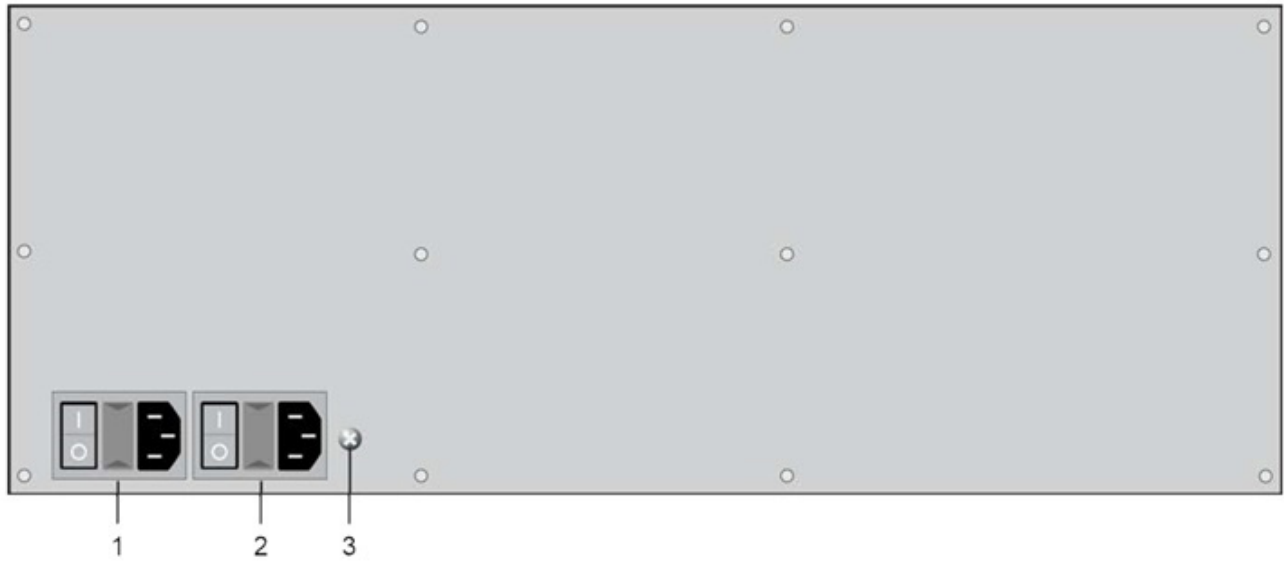

Figure 39. Front Panel, 144-Port Model with All Fiber Ports

- |                              |                                |
|------------------------------|--------------------------------|
| 1 – I/O Ports 1 through 8    | 12 – I/O Ports 33 through 40   |
| 2 – I/O Ports 41 through 48  | 13 – I/O Ports 73 through 80   |
| 3 – I/O Ports 9 through 16   | 14 – I/O Ports 81 through 88   |
| 4 – I/O Ports 49 through 56  | 15 – I/O Ports 121 through 128 |
| 5 – I/O Ports 17 through 24  | 16 – I/O Ports 89 through 96   |
| 6 – I/O Ports 57 through 64  | 17 – I/O Ports 129 through 136 |
| 7 – Network Port 1 (RJ45)    | 18 – I/O Ports 97 through 104  |
| 8 – Network Port 2 (RJ45)    | 19 – I/O Ports 137 through 144 |
| 9 – Reset button             | 20 – I/O Ports 105 through 112 |
| 10 – I/O Ports 25 to 32      | 21 – I/O Ports 113 through 120 |
| 11 – I/O Ports 65 through 72 |                                |

## Orion FX 144-Port Models (Continued)



**Figure 40. Rear Panel, 144-Port Models**

- 1 – Power supply connector (standard)
- 2 – Power supply connector (redundant)
- 3 – Grounding

## Orion FX 160-Port Models

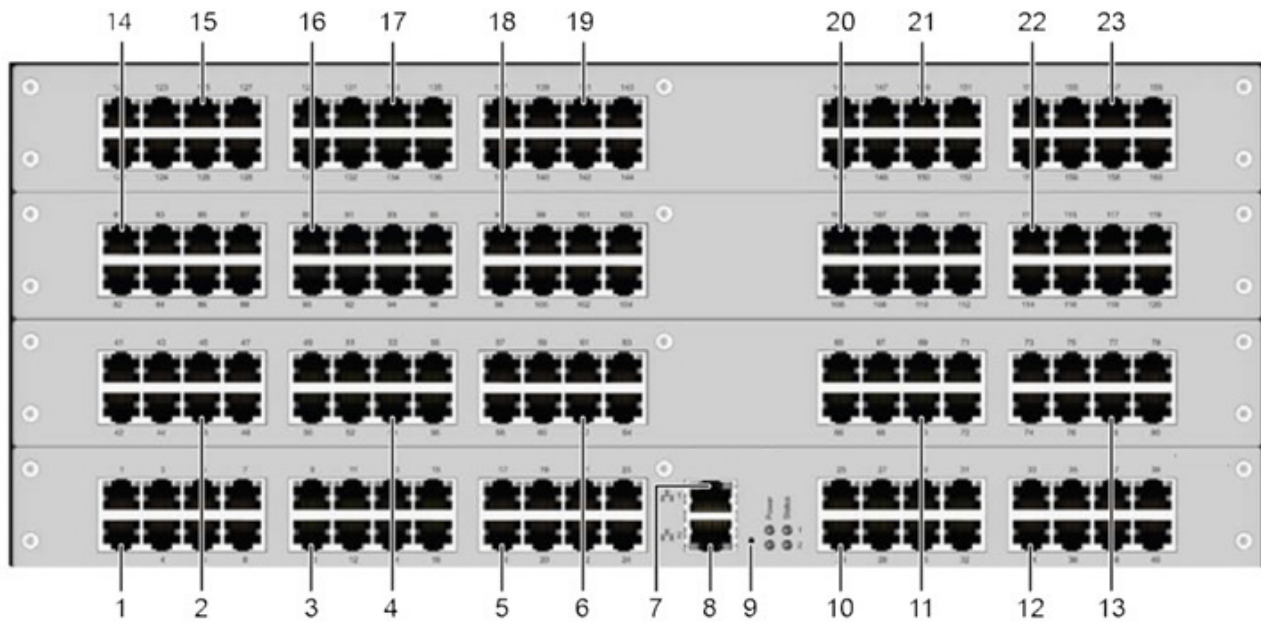

Figure 41. Front Panel, 160-Port Model with All CATx Ports

- |                             |                                |
|-----------------------------|--------------------------------|
| 1 – I/O Ports 1 through 8   | 13 – I/O Ports 73 through 80   |
| 2 – I/O Ports 41 through 48 | 14 – I/O Ports 81 through 88   |
| 3 – I/O Ports 9 through 16  | 15 – I/O Ports 121 through 128 |
| 4 – I/O Ports 49 through 56 | 16 – I/O Ports 89 through 96   |
| 5 – I/O Ports 17 through 24 | 17 – I/O Ports 129 through 136 |
| 6 – I/O Ports 57 through 64 | 18 – I/O Ports 97 through 104  |
| 7 – Network Port 1 (RJ45)   | 19 – I/O Ports 137 through 144 |
| 8 – Network Port 2 (RJ45)   | 20 – I/O Ports 105 through 112 |
| 9 – Reset button            | 21 – I/O Ports 145 through 152 |
| 10– I/O Ports 25 to 32      | 22 – I/O Ports 113 through 120 |
| 11– I/O Ports 65 through 72 | 23 – I/O Ports 153 through 160 |
| 12– I/O Ports 33 through 40 |                                |

## Orion FX 160-Port Models (Continued)

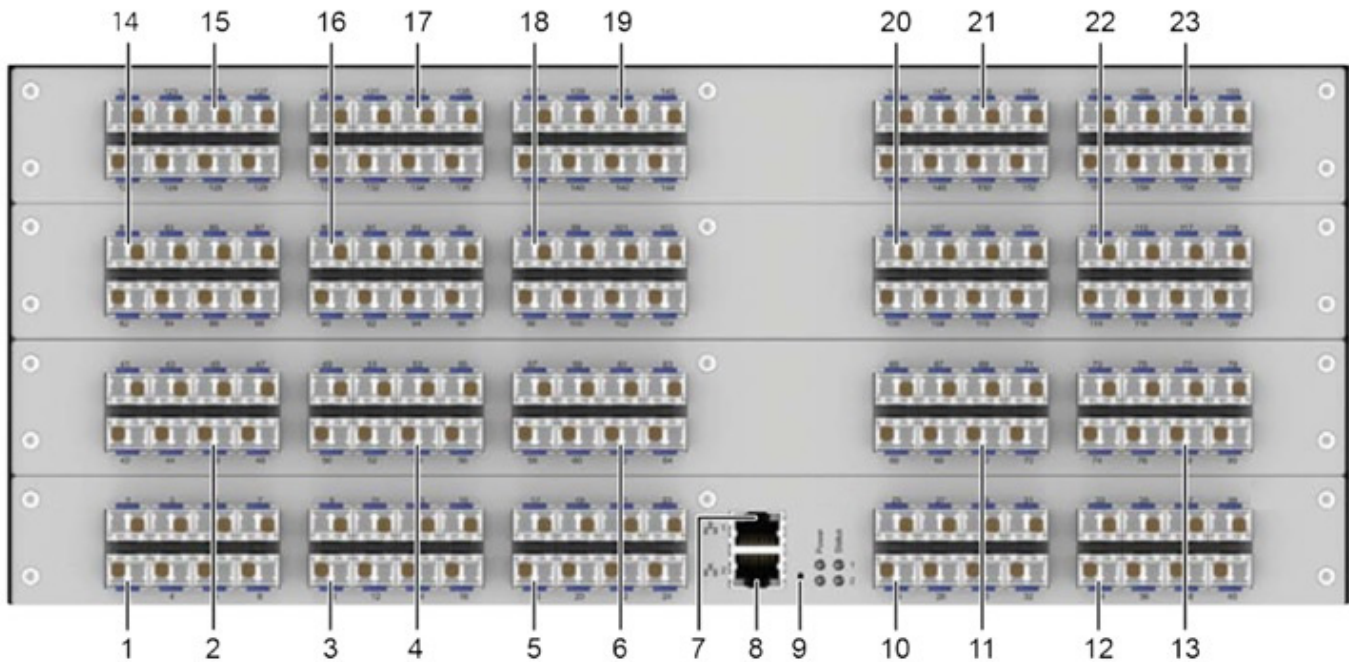

Figure 42. Front Panel, 160-Port Model with All Fiber Ports

- |                              |                                |
|------------------------------|--------------------------------|
| 1 – I/O Ports 1 through 8    | 13 – I/O Ports 73 through 80   |
| 2 – I/O Ports 41 through 48  | 14 – I/O Ports 81 through 88   |
| 3 – I/O Ports 9 through 16   | 15 – I/O Ports 121 through 128 |
| 4 – I/O Ports 49 through 56  | 16 – I/O Ports 89 through 96   |
| 5 – I/O Ports 17 through 24  | 17 – I/O Ports 129 through 136 |
| 6 – I/O Ports 57 through 64  | 18 – I/O Ports 97 through 104  |
| 7 – Network Port 1 (RJ45)    | 19 – I/O Ports 137 through 144 |
| 8 – Network Port 2 (RJ45)    | 20 – I/O Ports 105 through 112 |
| 9 – Reset button             | 21 – I/O Ports 145 through 152 |
| 10 – I/O Ports 25 to 32      | 22 – I/O Ports 113 through 120 |
| 11 – I/O Ports 65 through 72 | 23 – I/O Ports 153 through 160 |
| 12 – I/O Ports 33 through 40 |                                |

## Orion FX 160-Port Models (Continued)

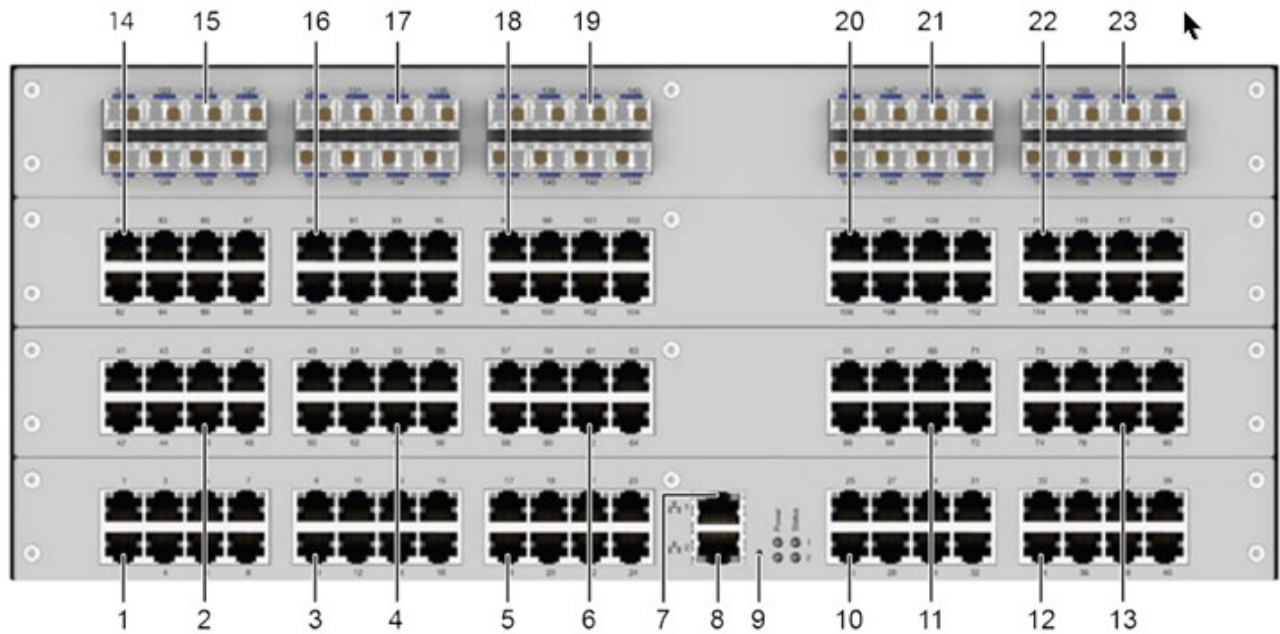

Figure 43. Front Panel, 160-Port Model with 120 CATx Ports and 40 Fiber Ports

- |                              |                                |
|------------------------------|--------------------------------|
| 1 – I/O Ports 1 through 8    | 13 – I/O Ports 73 through 80   |
| 2 – I/O Ports 41 through 48  | 14 – I/O Ports 81 through 88   |
| 3 – I/O Ports 9 through 16   | 15 – I/O Ports 121 through 128 |
| 4 – I/O Ports 49 through 56  | 16 – I/O Ports 89 through 96   |
| 5 – I/O Ports 17 through 24  | 17 – I/O Ports 129 through 136 |
| 6 – I/O Ports 57 through 64  | 18 – I/O Ports 97 through 104  |
| 7 – Network Port 1 (RJ45)    | 19 – I/O Ports 137 through 144 |
| 8 – Network Port 2 (RJ45)    | 20 – I/O Ports 105 through 112 |
| 9 – Reset button             | 21 – I/O Ports 145 through 152 |
| 10 – I/O Ports 25 to 32      | 22 – I/O Ports 113 through 120 |
| 11 – I/O Ports 65 through 72 | 23 – I/O Ports 153 through 160 |
| 12 – I/O Ports 33 through 40 |                                |

## Orion FX 160-Port Models (Continued)

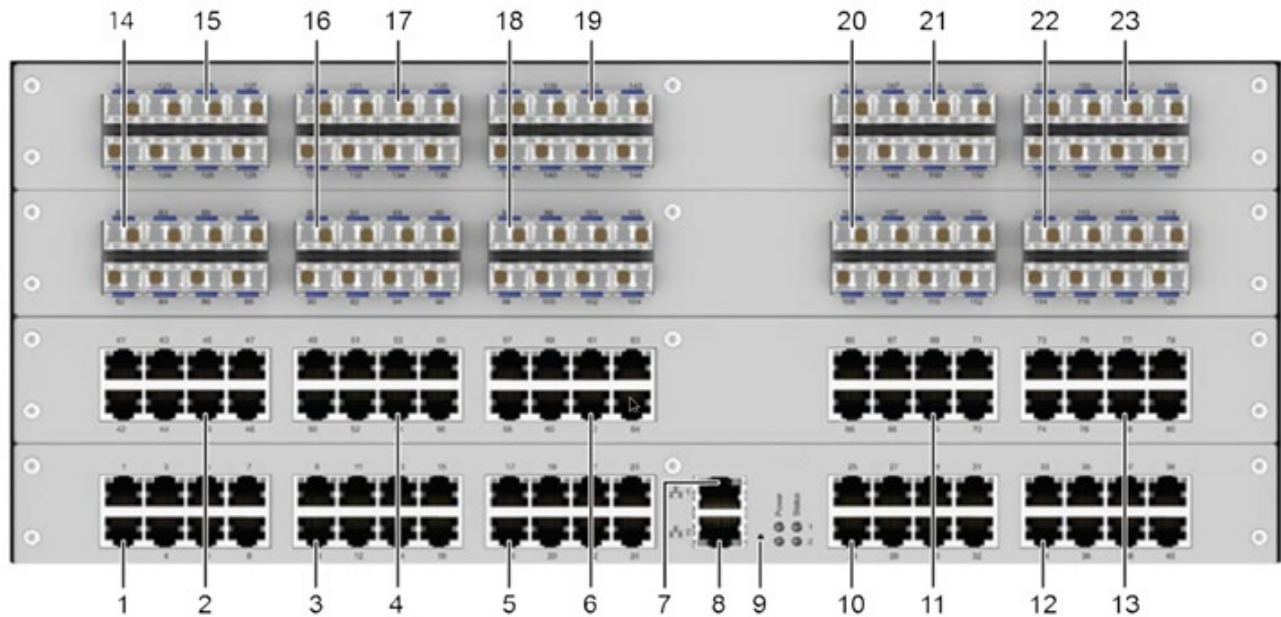
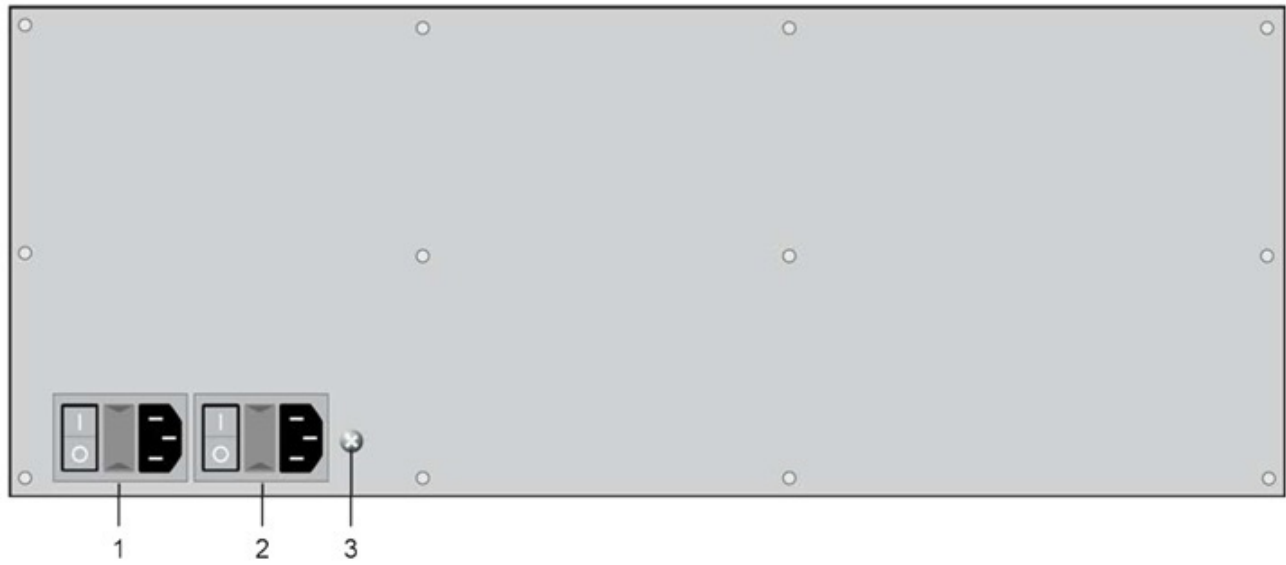

Figure 44. Front Panel, 160-Port Model with 80 CATx Ports and 80 Fiber Ports

- |                             |                                |
|-----------------------------|--------------------------------|
| 1 – I/O Ports 1 through 8   | 13 – I/O Ports 73 through 80   |
| 2 – I/O Ports 41 through 48 | 14 – I/O Ports 81 through 88   |
| 3 – I/O Ports 9 through 16  | 15 – I/O Ports 121 through 128 |
| 4 – I/O Ports 49 through 56 | 16 – I/O Ports 89 through 96   |
| 5 – I/O Ports 17 through 24 | 17 – I/O Ports 129 through 136 |
| 6 – I/O Ports 57 through 64 | 18 – I/O Ports 97 through 104  |
| 7 – Network Port 1 (RJ45)   | 19 – I/O Ports 137 through 144 |
| 8 – Network Port 2 (RJ45)   | 20 – I/O Ports 105 through 112 |
| 9 – Reset button            | 21 – I/O Ports 145 through 152 |
| 10– I/O Ports 25 through 32 | 22 – I/O Ports 113 through 120 |
| 11– I/O Ports 65 through 72 | 23 – I/O Ports 153 through 160 |
| 12– I/O Ports 33 through 40 |                                |

## Orion FX 160-Port Models (Continued)



**Figure 45. Rear Panel, 160-Port Models**

- 1 – Power supply connector (standard)
- 2 – Power supply connector (redundant)
- 3 – Grounding

# INSTALLATION

---

## Installation

---

The installation section of this manual explains the basic system setup. It also describes in detail how to set up the Orion FX as a KVM Matrix, how to stack Orion FX matrices, and how to make a grid of matrices.

### System Setup

It is recommended that first time users initially connect all of the system components in the same room as a test setup. This will facilitate identifying and correcting any cabling problems, and simplify the system configuration process.

#### *Setup of the matrix*

Configure the Orion FX matrix as follows.

1. Connect a CON Unit to an I/O port of the matrix.
2. Connect a keyboard, mouse and monitor to the CON unit.
3. Apply power to the Orion FX and the CON unit.
4. Display the OSD menu by typing <'Hot Key'>, <'o'> (default hot key sequence is 2x <Left Shift>).
5. Select **Configuration**, and login with administrator rights (default user is "admin", password "admin").
6. Configure according to application requirements.
7. Select **Save** in the Configuration menu, and then select **Restart Matrix**.
8. *Optional:* Establish a network connection between the matrix and a computer running the Java Tool in order to perform extended configuration. The default IP address is 192.168.100.99, with DHCP deactivated. Java Tool set up is described in [Control through the Java Tool](#) below.

Note: When installing several Orion FX switches at the same time, it is strongly recommended to install them one at a time and to assign unique IP addresses to each in order to avoid IP address conflicts

#### *Setup of Extenders*

Configure the CPU and CON units as follows.

1. Connect CON units to the matrix using CATx or fiber interconnect cables.
2. Connect the CON units to their console devices (monitor, keyboard and mouse).
3. Connect the 5VDC power supply units to the CON units and apply power.
4. Check the basic function of the CON units by displaying the OSD menu with <'Hot Key'>, <o> (default hot key sequence is 2x <Left Shift>).
5. Connect the sources (computer, CPU) to CPU units using the provided video and USB cables.
6. Connect the CPU unit to the matrix using CATx or fiber interconnect cables.
7. Connect the 5VDC power supplies to the CPU units.
8. Start the system by applying power to the Matrix.

## Possible Orion FX Setups

The Orion FX can be set up in a variety of ways to provide the optimal system environment. Some parts of the Orion FX can be configured for single display computers, with other parts for multi-display computers. The KVM and USB 2 support can also be configured.

While the Orion FX can be configured using the OSD of a connected CON unit, it can also be configured through a network connection with a computer running the Java Tool.

The following sections illustrate some typical Orion FX configurations.

### KVM Matrix

In single-head mode, up to 160 ports can be used either as input or as output ports depending on the components and equipment. Non-blocking access is available to all users, i.e. user access is not limited by the activities of another user.

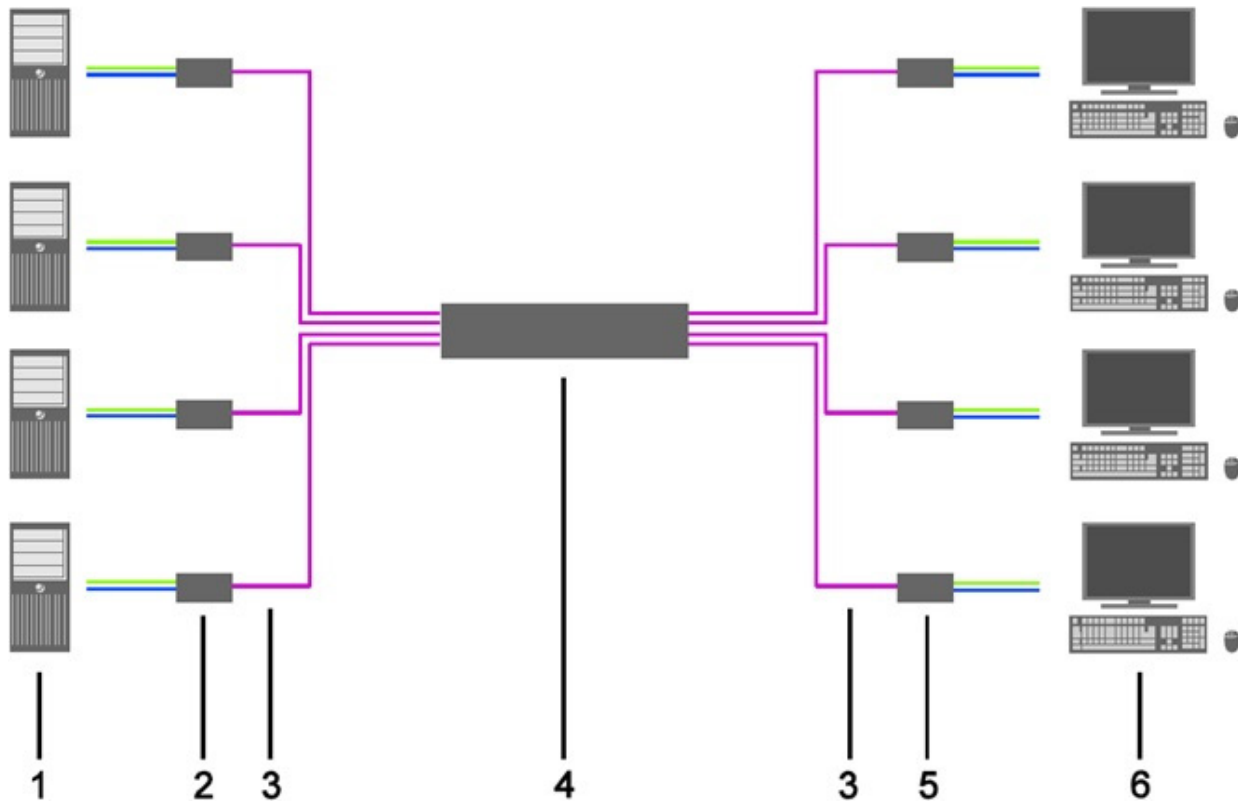

Figure 46. Single-head KVM Matrix

- |                            |  |
|----------------------------|--|
| 1 - Source (computer, CPU) | 2 - CPU Units                          |
| 3 - Interconnect cables    | 4 - Orion FX matrix                    |
| 5 - CON Units              | 6 - Console (monitor, keyboard, mouse) |

If a single-head console is used, it is possible to access dual-head or quad-head computers, but control is only possible at monitor 1.

Video from any source can be viewed by any number of monitors simultaneously. Audio (optional) can also be switched in the same manner.

### Parallel Operation (Stacking)

For installations with multiple monitors per workstation or additional support of USB 2.0 transmission paths, the number of connectable CPUs and consoles can be increased by parallel operation (stacking) of several Orion FX devices.

One Orion is configured as the **Master Matrix**, with its IP address entered into the **Master IP Address** field. All other Orion units in the system are configured as **Sub Matrices**. The Sub Matrices must be connected through their network connectors (RJ45) to the same network as the master matrix. The **Enable LAN Echo** option must be activated at the master matrix.

When a switching command is executed at the master matrix, the synchronized matrices will also switch automatically.

Switching of stacked devices might be delayed by several seconds.

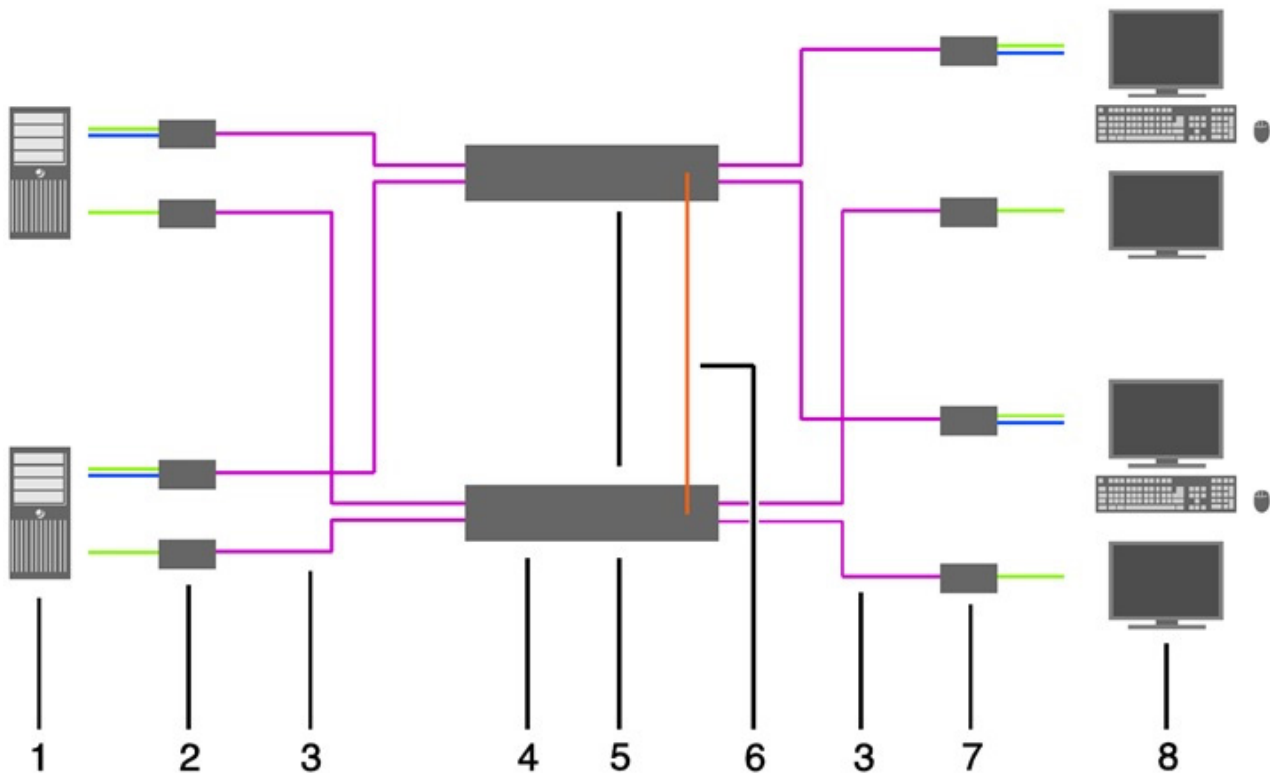

Figure 47. Parallel Operation (Stacking)

- |                                      |   |
|--------------------------------------|---|
| 1 - Dual-Head source (computer, CPU) | 5 - Synchronized Matrix                             |
| 2 - CPU unit                         | 6 - Network Connection Master / Synchronized Matrix |
| 3 - Interconnect cable               | 7 - CON unit  |
| 4 - Master Matrix                    | 8 - Console (2x monitor, keyboard, mouse)           |

## Matrix Grid

A Matrix Grid is a multiple matrix configuration which increases the total number of ports accessible beyond those in a single Orion FX. It is also useful when important equipment must be redundantly connected to several different matrix units. A Matrix Grid consists of a master matrix and at least one sub matrix. Up to 24 matrices can be interconnected in a matrix grid installation.

Orion units in a Matrix Grid are connected to each other by “Grid Lines”. The Grid Lines may connect the sub matrices directly to the master matrix or to other sub matrix units. The Matrix Grid can be set up in several ways, such as a ring, a hub and spokes, or a fully connected configuration, depending on where the Grid Lines are installed. Grid Line signals are bidirectional, and each one can support a KVM connection. All switching operations are exclusively performed through the Grid Master.

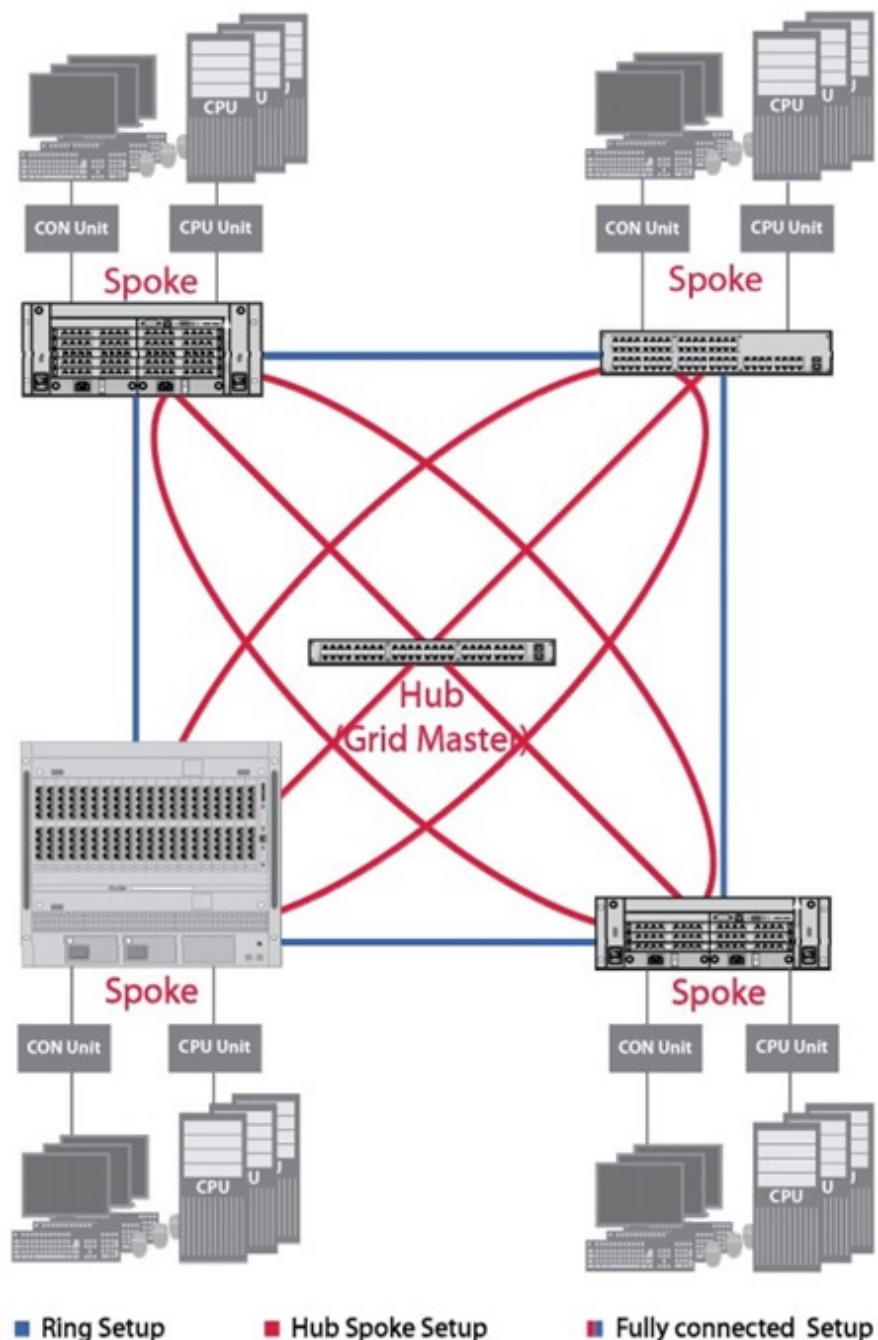

Figure 48. Matrix Grid

# CONFIGURATION

## Configuration

The Orion FX switch can be configured through keyboard commands in Command Mode, through the On-Screen Display menus, or using the Java Tool. These options are described below.

### Command Mode

The Orion FX Command Mode allows users to perform some functions through keyboard commands during normal use.

To enter Command Mode, use a 'Hot Key' sequence, and to exit Command Mode, press <Esc>. While in Command Mode, the **Caps Lock** and **Scroll Lock** LEDs on the console keyboard will flash repeatedly.

In Command Mode, normal keyboard and mouse operation will cease. Only valid keyboard commands are available.

If no keyboard command is executed within 10 seconds after activating Command Mode, the matrix will automatically exit Command Mode.

The following table lists the keyboard commands to enter and to exit Command Mode, and to change the 'Hot Key' sequence:

Function	Keyboard Command
Enter Command Mode (default)	2x <Left Shift> (or 'Hot Key')
Exit Command Mode	<Esc>
Change 'Hot Key' sequence	<current 'Hot Key'>, <c>, <new 'Hot Key' code>, <Enter>

Table 2. Basic Keyboard Commands

<Key> + <Key>      Press keys simultaneously  
<Key> , <Key>      Press keys successively  
2x <Key>              Press key quickly, twice in a row (similar to a mouse double-click)

The 'Hot Key' sequence to enter Command Mode can be changed. The following table lists the 'Hot Key' Codes for the available key sequences.

'Hot Key' Code	'Hot Key'
0	Freely selectable by user
2	2x <Scroll>
3	2x <Left Shift>
4	2x <Left Ctrl>
5	2x <Left Alt>
6	2x <Right Shift>
7	2x <Right Ctrl>
8	2x <Right Alt>

Table 3. Keyboard Commands - Hot Key Codes

### *Set user-defined 'Hot Key'*

When setting a user-defined 'Hot Key' (e.g. 2x<Space>), 'Hot Key' Code 0 is used. For example, to set 2x<Space> as the 'Hot Key', the following keyboard sequence would be used:  
<current 'Hot Key'>, <c>, <0>, <Space>, <Enter>.

### *Set 'Hot Key' for direct OSD access*

Besides using the 'Hot Key' for standard functions, a second 'Hot Key' can be set up to directly access the OSD.

To use one of the pre-defined 'Hot Key' Codes (Codes from 2 to 8) from Table 3, use the following keyboard sequence:

<current 'Hot Key'>, <f>, <'Hot Key' code>, <Enter>.

To specify a user-defined 'Hot Key' like 2x<Space>, use the following keyboard sequence:

<current 'Hot Key'>, <f>, <0>, <Space>, <Enter>.

### *Reset 'Hot Key'*

In order to set a 'Hot Key' back to the default settings of the extender, press the key combination <Right Shift>+<Del> within 5 seconds after switching on the CON unit or plugging in a keyboard.

To delete a 'Hot Key' for direct OSD access, use the following keyboard sequence:

<current 'Hot Key'>, <f>, <0>, <Del>, <Enter>.

## Control Options

The following methods are available to configure and operate the Orion FX:

- through a CON unit OSD
- through the Java Tool

### *Control through the OSD*

The Orion FX can be configured through the OSD (On-Screen-Display). The settings of the *Configuration* menu are described below. All other menus are described in later sections. You can access the OSD with a keyboard connected to a CON unit which is in the Orion FX system.

When making changes through the OSD, please note the following.

1. When the Okay button is clicked, all changes are applied to the active configuration and saved in the volatile memory of the matrix. In the event of a sudden power failure, these changes are lost. Perform one of the following operations to save the changes permanently.
  - Save the current configuration changes to the Orion FX unit as described on page 150.
  - Save the configuration to a specific storage as described on page 152.
  - Perform a restart of the unit as described on page 200.
2. A change in system-relevant parameters (e.g., change of the IP address) is immediately displayed in the OSD. To activate these system-relevant configuration changes on the matrix, the matrix must be restarted. The restart of the matrix may take several minutes, and the matrix will be unavailable during the restart.

### Entering the OSD

1. Start Command Mode with the 'Hot Key' (default: 2x <Left Shift>).
2. Press <o> to open OSD. If the **Enable CPU Selection** option (described in Console Extender OSD Settings section) is enabled in the **Configuration** menu, a selection list for switching between available CPU Devices is displayed. In that case, press <F7> to go to the OSD main menu.

### Leaving the OSD

➔ Press <Esc> in the main menu, or <Left Shift> + <Esc> from any OSD menu.

The OSD will be closed without any further changes and the currently active CPU connection will be displayed.

## Menu Structure

The general layout of the OSD is structured into three areas:

- Upper status area (topmost two text lines)
- Working area
- Lower status area (lowest two text lines)

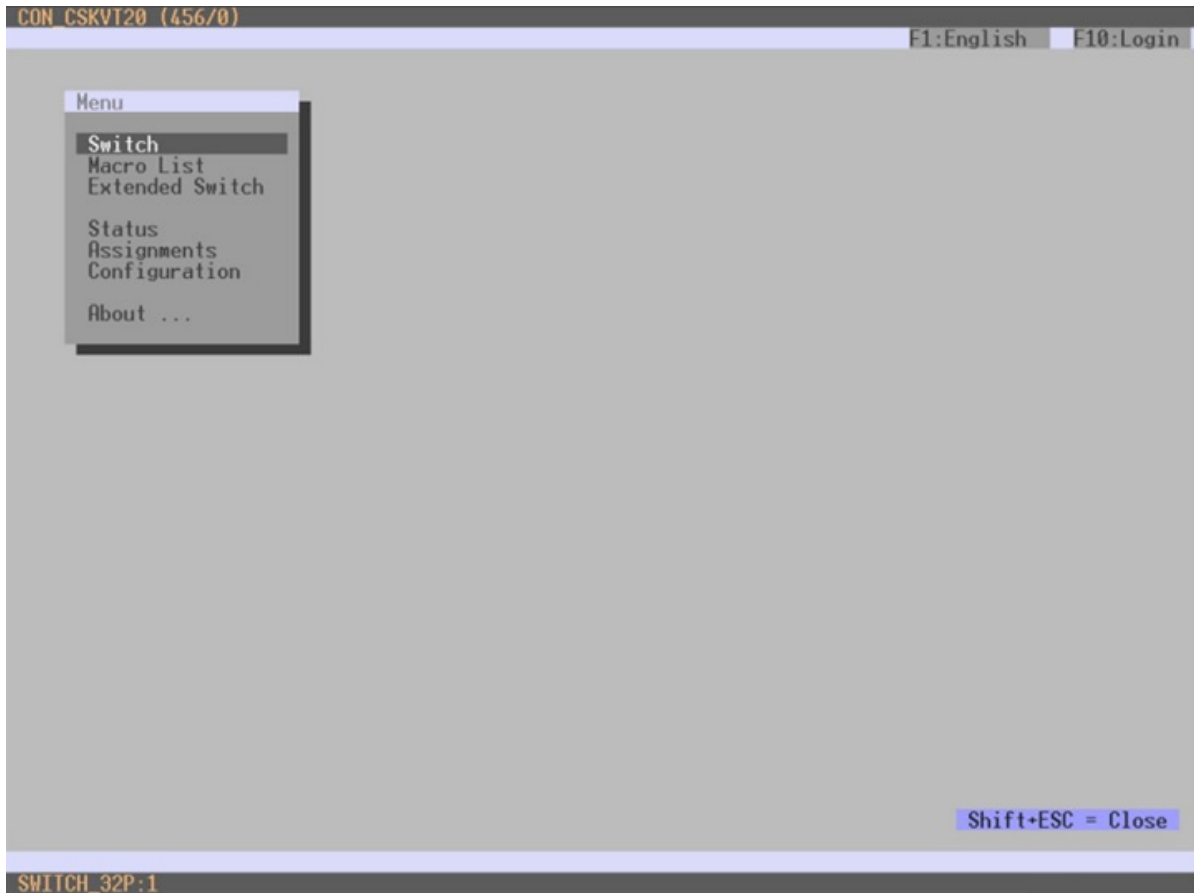

Figure 49. OSD Main Menu

The following functions are available in most menus:

Button	Function
Cancel	Discard changes
Okay	Apply changes (temporary storage of the active configuration in memory)

Table 4. Standard OSD Keyboard Commands

## OSD Keyboard controls

The following keyboard actions are available for navigation and configuration within the menus.

Keyboard Command	Function
<Cursor Left>	Input field: cursor left
	In menus: next input field
<Cursor Right>	Input field: cursor right
	In menus: previous input field
<Cursor Up>	In input fields: Line up (with wrap around)
	In menus: Line up (without wrap around)
<Cursor Down>	In input fields: Line down (with wrap around)
	In menus: Line down (without wrap around)
<Page Up>	Previous page, in menus with more than one page
<Page Down>	Next page in menus with more than one page
<Tab>	In menus with input fields, next input field
<Left Shift> + <Tab>	In menus with input fields, previous input field
<+>	In selection fields, next option
	In CPU selection list, with cursor on a CPU Group, expand group
<->	In selection fields, previous option
	In CPU selection list, with cursor on a CPU Group, collapse group
<Space>	Switching in selection fields between two conditions, e.g. between <b>ON</b> / <b>OFF</b> or <b>Y</b> (Yes) / <b>N</b> (No)
<Enter>	In menus with input fields, save data
	In menus, select menu item
	With buttons, confirm selected button
<Esc>	In menus with input fields, cancel input data without saving
	In menus with selection fields: Go back to the higher level menu

**Table 5. Keyboard Controls in the OSD**

## Sorting Functions

Keyboard commands can be used with lists and tables in the OSD, to quickly sort, search, and refresh the items displayed. The following sorting options are available:

Keyboard Command	Function
<F1>	Sort by ID numbers in descending order by pressing the keyboard command once.
	Sort by ID numbers in ascending order by pressing the keyboard command twice ( <b>ID</b> ).
<F2>	Sort by ID names in descending order by pressing the keyboard command once.
	Sort by ID names in ascending order by pressing the keyboard command twice ( <b>Name</b> ).
<F3>	Go to the next result in the list of results of the search field ( <b>Next</b> ).
<F4>	Go to the previous result in the list of results of the search field ( <b>Previous</b> ).
<F5>	Refresh the currently displayed list ( <b>Refresh</b> ).
<F6>	Jump between the search field and the list of results ( <b>Find</b> ).
<F8>	Show unavailable CPUs
<F9>	Activate search function from the beginning of the name ( <b>Compare</b> )

**Table 6. OSD Sorting Functions**

## Password request

Access to the configuration menu requires login with administrator rights. The default user name and password for the admin account are as follows:

Field	Default Value
User	admin
Password	admin

**Table 7. Default Login Settings**

To access the configuration menu, proceed as follows:

1. Press the <F10> key in the main menu of the OSD. The login screen appears.
2. Enter the login data of the administrator

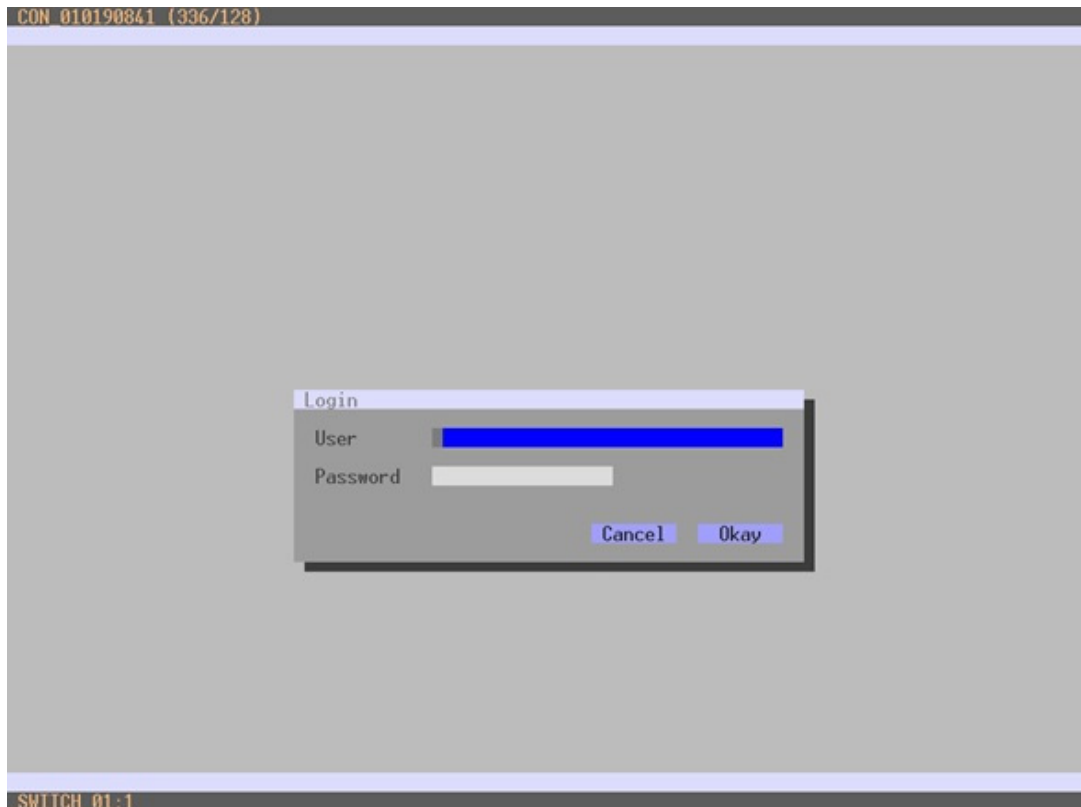

**Figure 50. Configuration Login Screen in the OSD**

For security reasons, this administrator password should be changed as soon as possible.

To log out, press the <F10> key again.

After the administrator user name and password are entered, the Configuration menu is displayed.

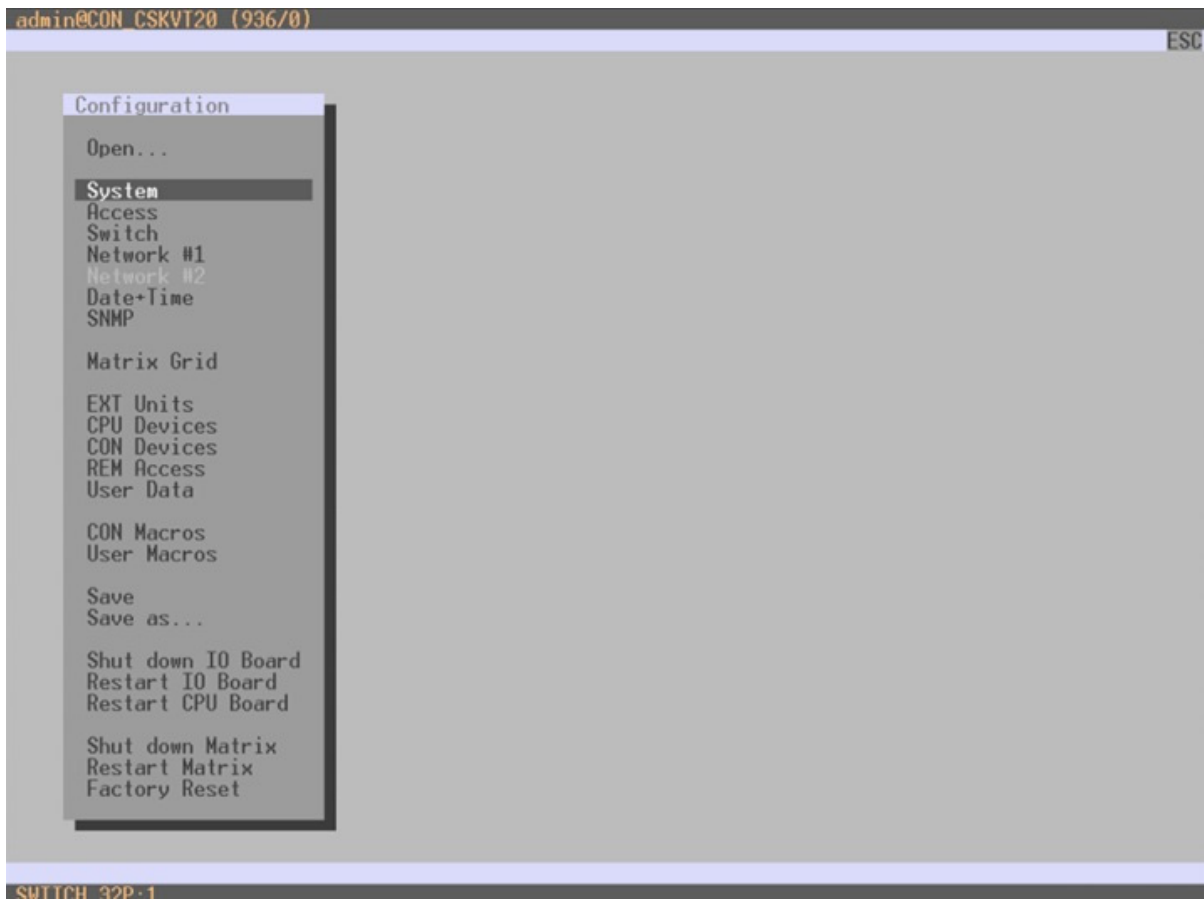

Figure 51. Configuration Menu in the OSD

## *Control through the Java Tool*

### Requirements

The following requirements have to be met to use the Java Tool:

- Minimum RAM of 512 MB
- Operating System with integrated Java Runtime:
  - Microsoft Windows: 8, 8.1, 10
- Operating System with a user-installed Java Runtime Environment
  - Microsoft Windows: 8, 8.1, 10
  - MacOS: 10.14 (Mojave) or higher, Intel platform
  - Oracle Java Runtime Environment (JRE) 1.8.x or higher
  - Strongly recommended: Oracle Java 1.8 update 152, or higher.
- Java Tool software
- Available network connection between the computer running the Java Tool and the matrix

Contact the system administrator concerning JRE and the network connection.

### Installation of the Java Tool

The Java Tool is available as a single executable program file that does not require installation.

→ Copy the tool to a directory on the computer.

If the Java Tool was not provided, contact Rose Electronics.

### Computer Connection to the Matrix

Use a crossover network cable for a direct connection between the Java Tool computer and the matrix, or a standard CATx cable for a connection through an Ethernet switch or hub.

Do not use a network connection between the Java Tool computer and Orion FX that is primarily used to transmit audio data.

→ Use the appropriate network cable(s) to make the desired connections between the RJ45 ports of the computer and the RJ45 network port of the Orion FX.

### Starting the Java Tool

→ Open the Java Tool by double clicking the program icon or selecting the program and pressing the <Enter> key on the keyboard.

## Connecting to the Orion X

FTP rights are required.

1. Open the Java Tool.
2. Select **Device > Connect** in the menu bar, and enter the IP address of the matrix in the pop-up input field.



Figure 52. Java Tool Device Connect

3. Enter the administrator user name and password for the Orion FX.
4. Confirm the inputs by clicking the **Login** button or select **Cancel** to abort login.
5. Alternatively, select **Device > Device Finder** in the menu bar, or click the **Device Finder** icon in the toolbar.
6. Select from the Orion FX units found and click the **Connect** button. Administrator log in is required.

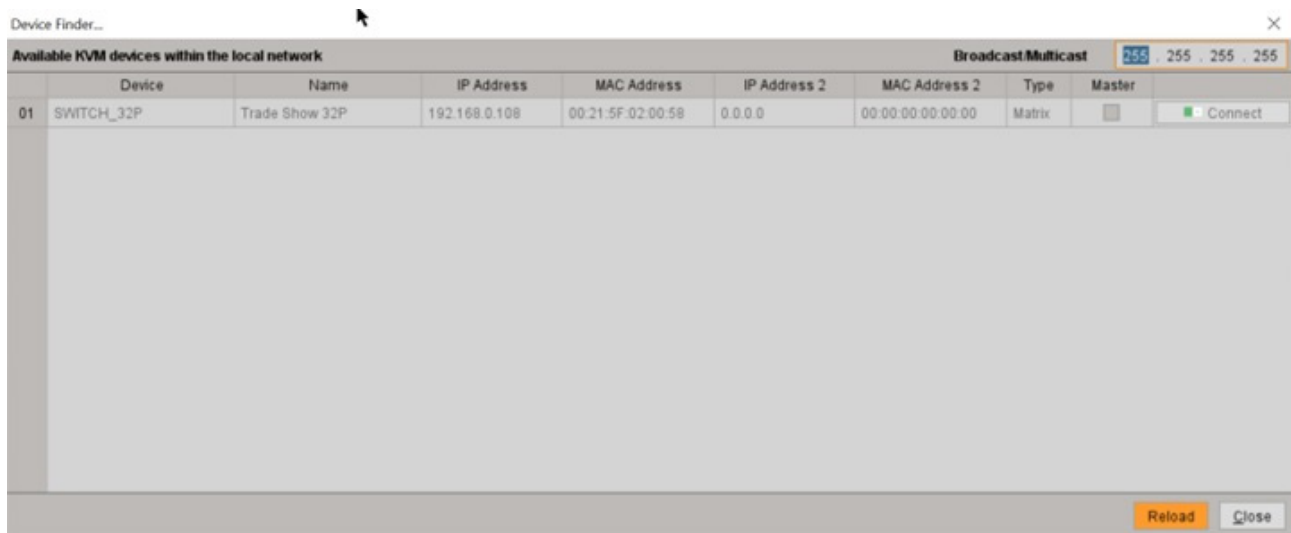

Device	Name	IP Address	MAC Address	IP Address 2	MAC Address 2	Type	Master
01 SWITCH_32P	Trade Show 32P	192.168.0.108	00:21:5F:02:00:58	0.0.0.0	00:00:00:00:00:00	Matrix	<input type="checkbox"/>

Figure 53. Device Finder in the Java Tool

Up to twelve connections between the matrix and Java Tool software can be established at the same time.

## Java Tool Menu Structure

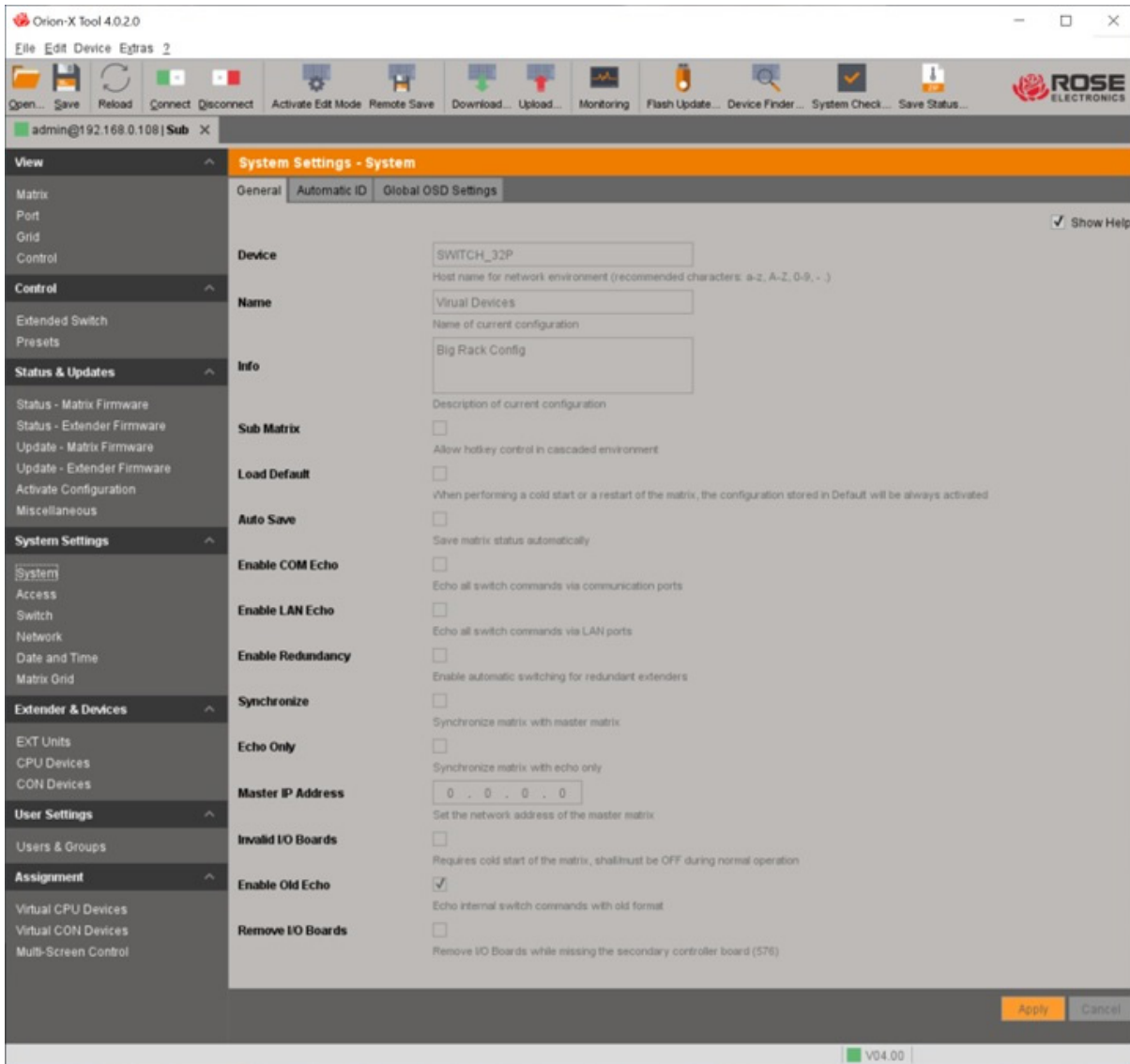

Figure 54. System Settings – System Screen in the Java Tool

The Java Tool screen is subdivided into various sections:

- Menu bar (top line)
- Toolbar (second line with function icons)
- Tab bar (third line)
- Task area (left menu section below the Tab bar)
- Working area (right menu section below the Tab bar)
- Status bar (bottom line)

## Operating Instructions

The operation of the Java Tool is intuitive, because the Tool is similar to the user interface of common operating systems.

The integrated help texts in the working area of the Java Tool can be activated or deactivated by clicking the **Show Help** checkbox in the upper right corner of the working area.

### Mouse Controls in the Java Tool

The following mouse commands are available

Mouse Command	Function
Left mouse button click	Menu selection, marking
Double click left mouse button	Open function-specific selection menus
Right mouse button click	Open context-specific selection menus

Table 8. Mouse Controls in the Java Tool

### Keyboard Controls in the Java Tool

The following keyboard commands are available.

Keyboard Command	Function
<Cursor Left>	Cursor to the left
<Cursor Right>	Cursor to the right
<Cursor Up>	Line up
<Cursor Down>	Line down
<Page Up>	Previous page in input or status menus with more than one page
<Page Down>	Next page in input or status menus with more than one page
<Tab>	Next field in input menus
<Left Shift> + <Tab>	Previous field in input menus
<Space>	Switching in selection fields between two conditions (checkmark or not) Open already marked fields for editing or selecting
<Enter>	Menu item selection In menus: Data saving
<Ctrl> + <Tab>	Leave tables Jump from tables into the next field
<Ctrl> + <Left Shift> + <Tab>	Leave tables Jump from tables into the previous field

Table 9. Keyboard Controls in the Java Tool

Some of the functions in the menu bar can be executed with keyboard commands listed to the right of the menu item (e.g. press <Ctrl> + <S> to execute **Save**).

### Reload Options

The information shown in the Java Tool can be reloaded in different ways.

- By pressing <F5> on the keyboard
- By clicking **Edit > Reload** in the menu bar
- By clicking the "Reload" symbol in the symbol bar

## Context Function

The Java Tool offers several context-specific functions that support user-friendly operation. The individual context specific functions are described in their respective chapters.

➔ To execute a context-specific function, click the right mouse button on the corresponding field and select the desired function.

## Sorting Function

Lists and tables in the Java Tool have sorting functions for easy searching.

Sort Function	Action	Result
Ascending sort	Click the left mouse button once on the header of the column to be sorted	The column is sorted in ascending order, with an arrow pointing upwards to indicate the sort type
Descending sort	Click the left mouse button twice on the header of the column to be sorted	The column is sorted in descending order, with an arrow pointing downwards to indicate the sort type
Cancel sort	Click the left mouse button once or twice on the head of the sorted column	The displayed arrow disappears

**Table 10. Java Tool Sorting Functions**

## Filter Function

Lists and tables in the Java Tool can also be filtered to display only relevant results. An active filter is indicated by an asterisk in the header.

Filter Function	Action	Result
Activate filter	Click the left mouse button in the filter entry field above the header. Then type the word or part of a word to be used to filter.	The filter results are displayed immediately. The filter symbol is displayed in green.
Cancel filter	Delete the text in the filter entry field	The list or table shows the complete content. The filter symbol is displayed in gray.

**Table 11. Java Tool Filter Functions**

## Offline Configuration

Configuration and system settings can be changed via the Java Tool in offline mode, without a direct connection between the tool and Orion FX. Afterwards, the configuration must be uploaded to the matrix.

To activate an Orion FX configuration created offline, proceed as follows:

1. Select **File > Upload** in the menu bar.
2. Enter the IP address of the Orion FX, the admin user name and password, and the storage location of the new configuration (**default**, or **config01 - config08**) in the **Select Configuration Slot** menu.
3. Select **Device > Connect** in the menu bar and once again enter the IP address of the Orion FX, the user name and password.
4. Select **Status & Updates > Activate Configuration** in the task area and select the storage location that was selected in step 2.
5. Use the **Activate** button to load the selected configuration in the Orion FX.
6. The connection and the open tab will be closed and the Orion FX will restart.

During the activation of a configuration, the matrix is temporarily unavailable.

## Online Configuration

Configurations and system settings can also be modified when the Java Tool is in **Edit Mode** with an active connection between matrix and Java Tool.

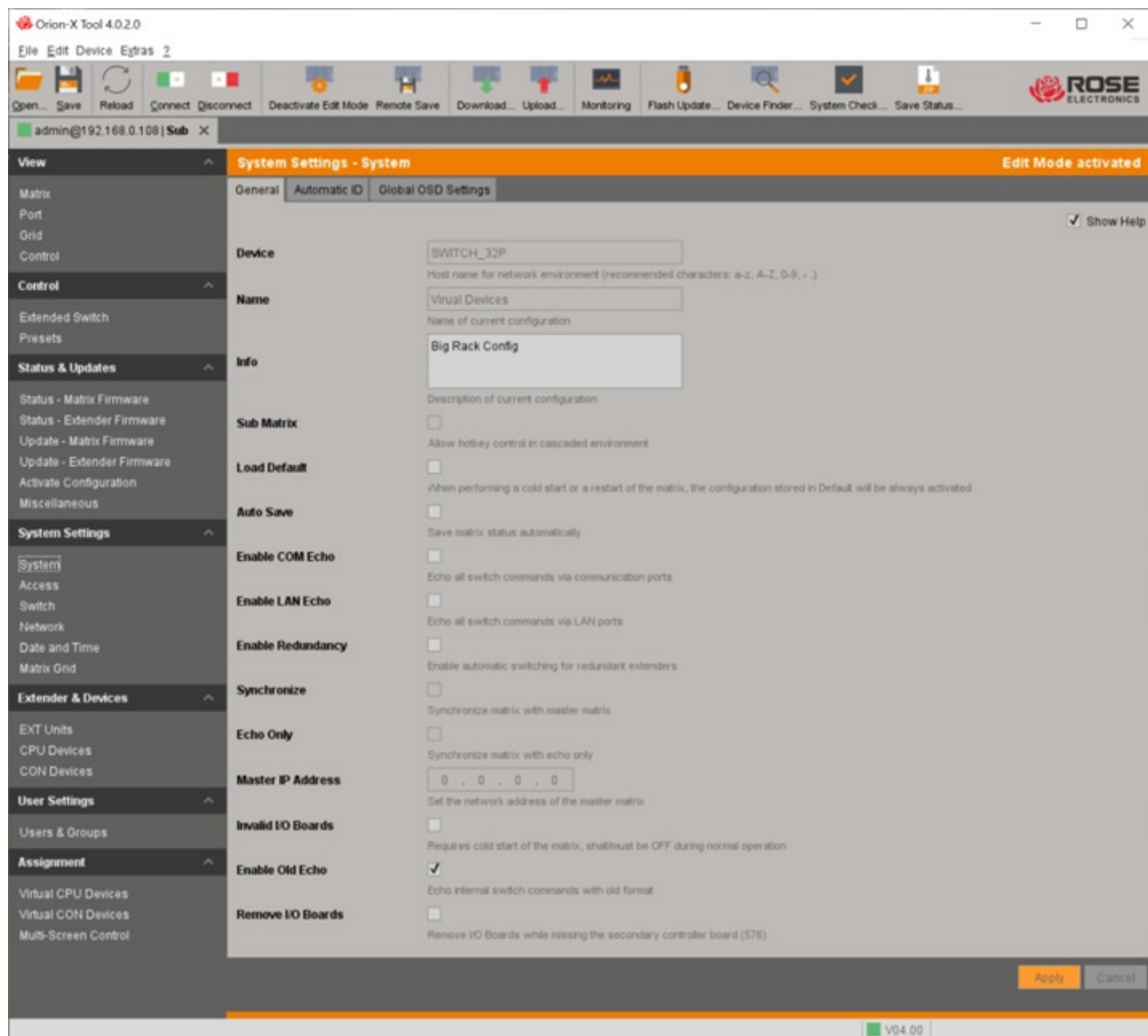

Figure 55. Java Tool Online Configuration

To change a configuration in **Edit Mode**, proceed as follows:

1. Select the menu item **Device > Activate Edit Mode** or click the icon in the Toolbar. The setting will also be shown on the right side of the title bar of the working area.
2. Make any edits in the configuration and system settings, and confirm by clicking the **Apply** button. The changes will be applied immediately.
3. To deactivate **Edit Mode**, select the menu item **Device > Deactivate Edit Mode** in the menu bar.
4. Click the **Remote Save** button to save the configuration changes to the active configuration of the matrix.

## Setting Java Tool Options

### Default Settings

The Java Tool can be adapted and customized by changing its default settings. To activate or change the default settings, proceed as follows:

→ Select **Extras > Options** in the menu bar. The Options menu will open with **Default Settings** tab selected.

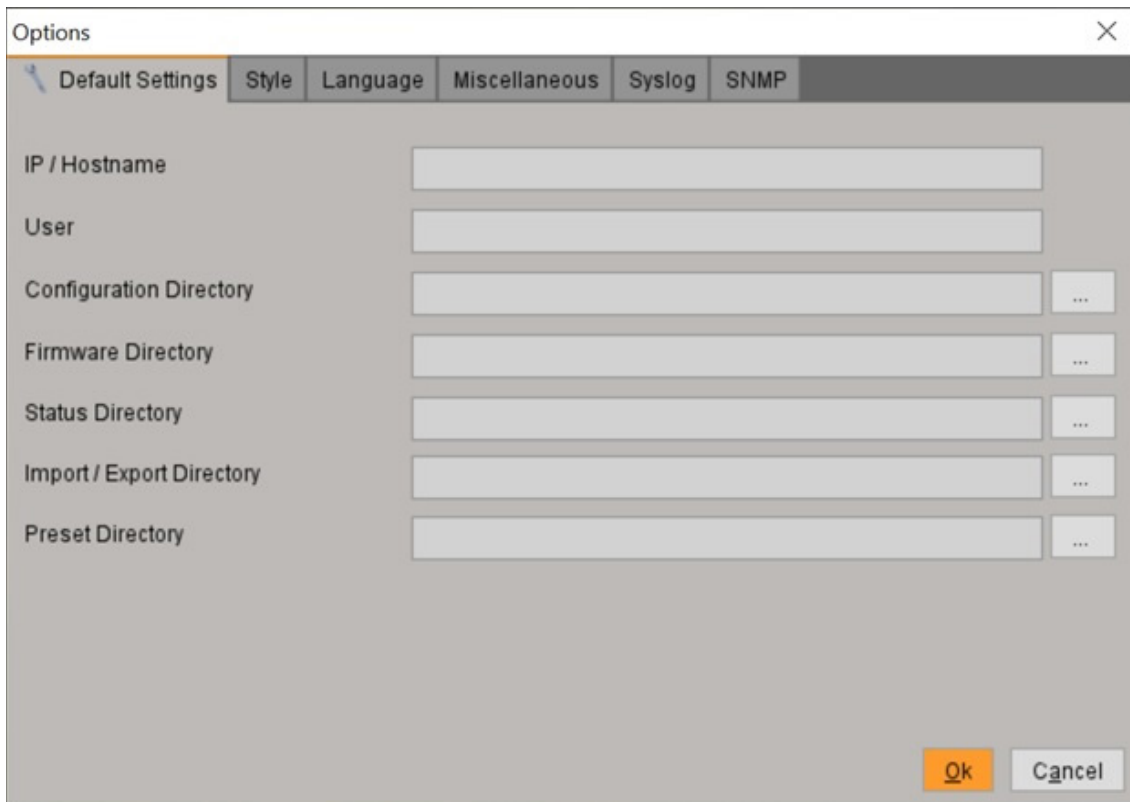

Figure 56. Default Settings Tab in the Java Tool Options Menu

The following default settings can be changed:

Option	Description
<b>IP / Hostname</b>	Default IP address of the matrix required for connection
<b>User</b>	Default user name required for connection
<b>Configuration Directory</b>	Default directory for configuration files
<b>Firmware Directory</b>	Default directory for update files
<b>Status Directory</b>	Default directory for the firmware status files
<b>Import / Export Directory</b>	Default directory for import and export files
<b>Preset Directory</b>	Default directory for macro files

Table 12. Java Tool Options

## Java Tool Style Settings

To set font size and color theme for the Java Tool, proceed as follows:

1. Select **Extras > Options** in the menu bar and click the **Style** tab.
2. Select the desired font size (**normal** or **large**).
3. Click the **Show Toolbar Button Text** checkbox to display tooltip when the mouse cursor hovers over a menu item in the toolbar.
4. Select the color theme for the software (Dark or Gray).
5. Click **Ok** to confirm the changes and then restart the software.

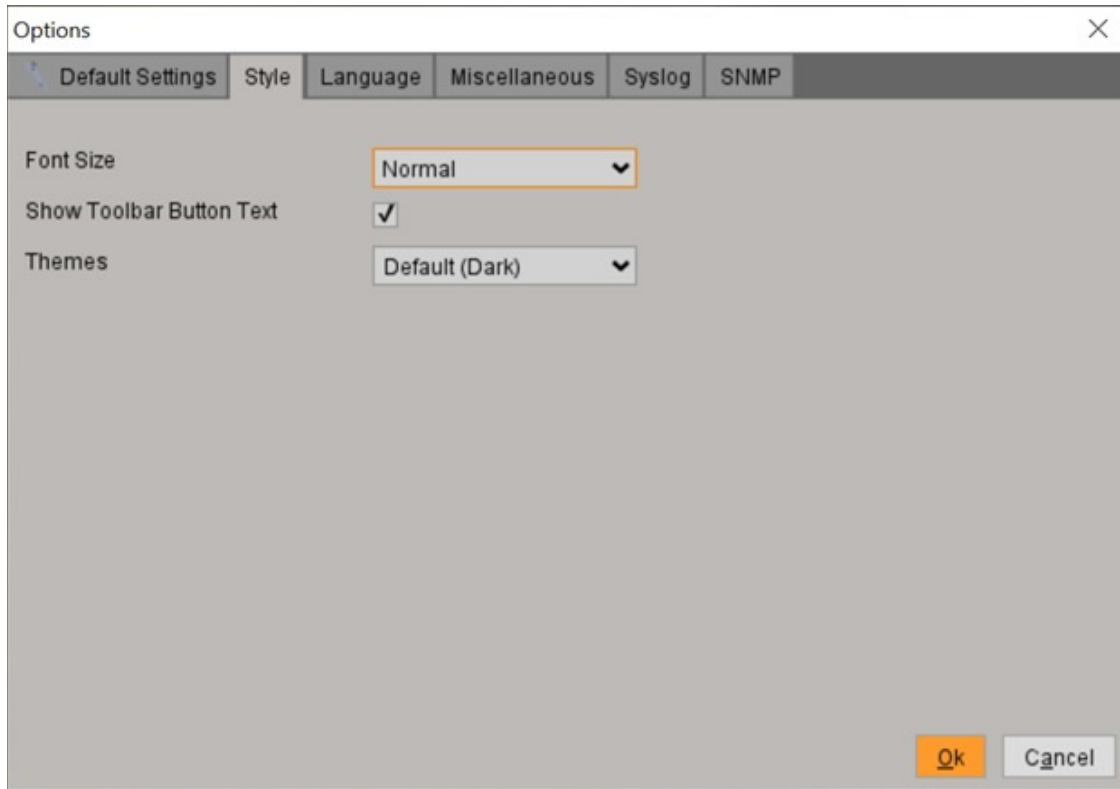

Figure 57. Java Tool Font Size, Tool Tips and Color Theme

## Java Tool Language

The language used in the Java Tool can be selected in this menu.

1. Select **Extras > Options** in the menu bar and open the **Language** tab.
2. Select the desired language and the corresponding character set.
3. Click **Ok** to confirm the changes.
4. Close the Java Tool software and restart it.

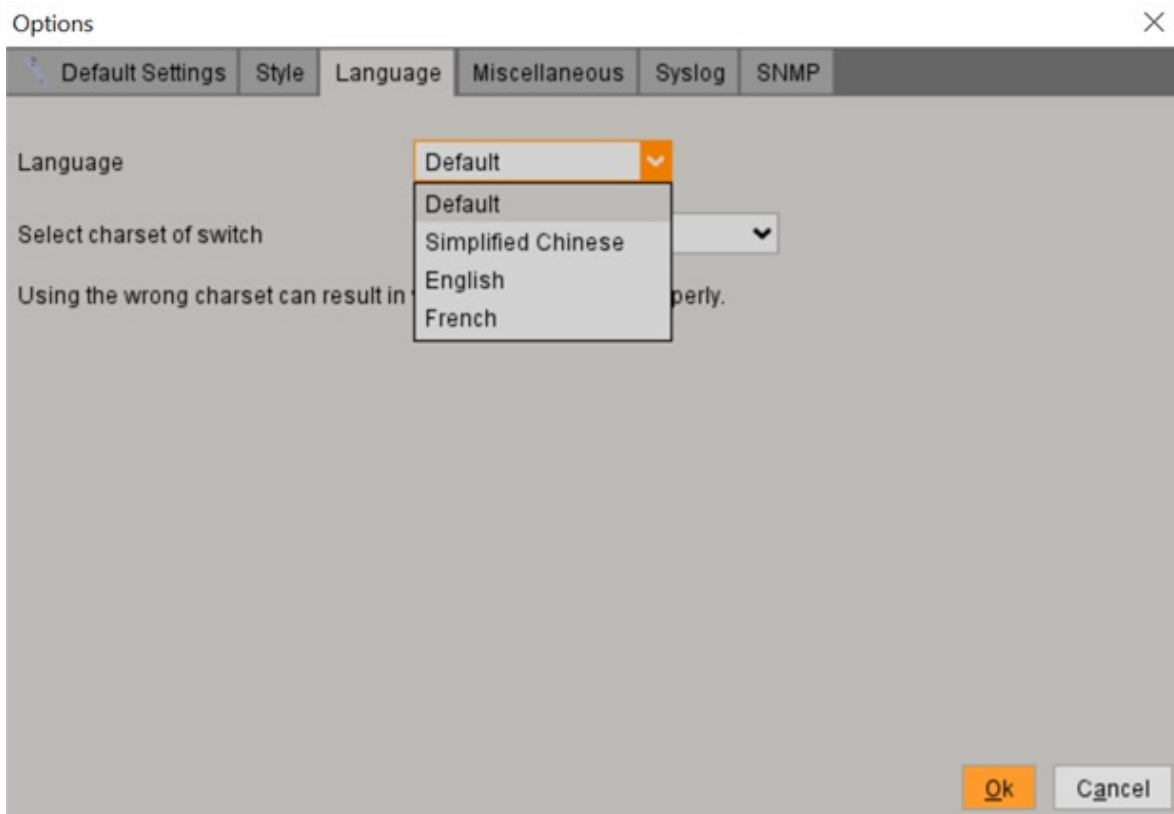

Figure 58. Java Tool Language and Character Set

### Java Tool Miscellaneous Options

Additional options for the Orion FX Java Tool are available in this menu.

Option	Description
<b>Device Finder on Startup</b>	Start the device Finder automatically at Java Tool startup
<b>Name Adoption</b>	Name entered for a device and also applied to the extender, and vice versa
<b>Show Super Grid View</b>	Show the Super Grid option in the task area
<b>Show power backplane and fan firmware</b>	Show the firmware of the fans and the power backplane in the menu <b>Status &amp; Updates &gt; Status – Matrix Firmware</b>
<b>Enable single I/O board update on compact switch</b>	Applies only to Orion FX
<b>Enable splitted firmware update (matrix and extender) for master and sub part of the 576 matrix</b>	Applies only to Orion X 576

Table 13. Java Tool Miscellaneous Options

1. Select **Extras > Options** in the menu bar and open the **Miscellaneous** tab.
2. Check or uncheck the selection boxes for the options to be changed.
3. Click **Ok** to confirm the changes.
4. Close the Java Tool software and restart it.

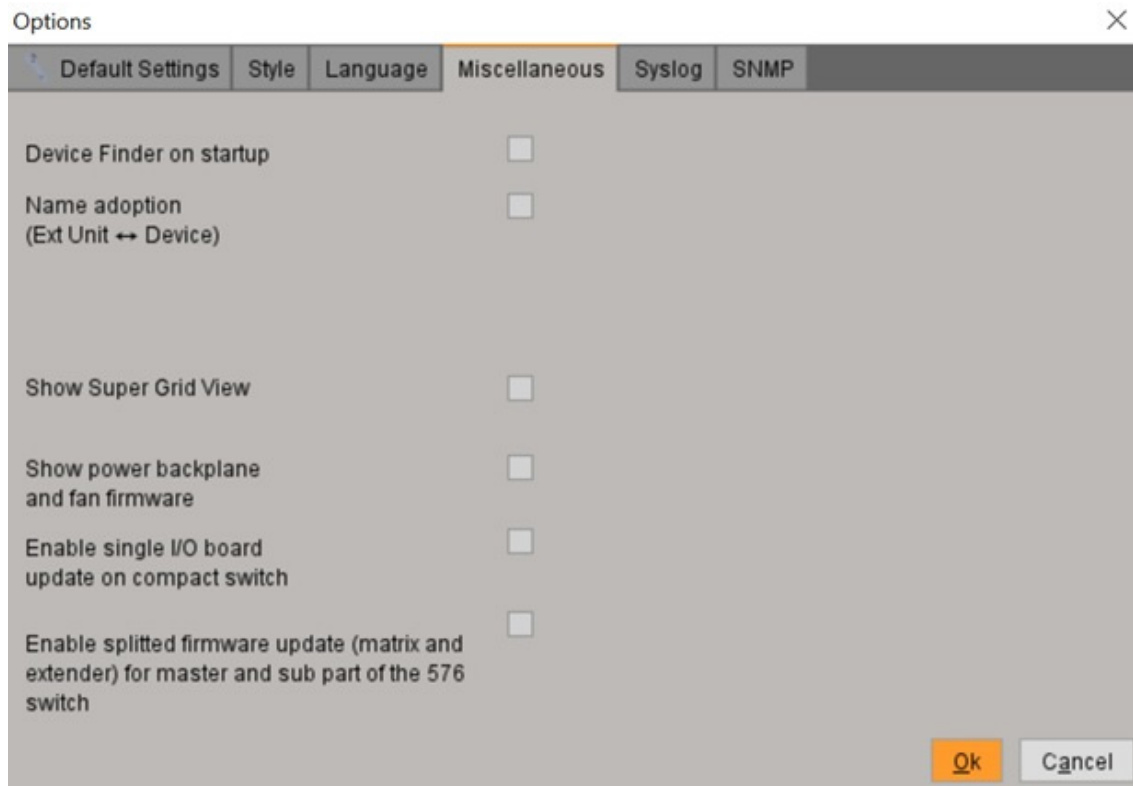

Figure 59. Java Tool Miscellaneous Options Menu

## Report

The Java Tool is equipped with a report function that exports the current switching status and all relevant parts of the matrix configuration to a PDF file.

To create a report, proceed as follows:

1. Select **File > Report...** in the menu bar. A selection assistant will be opened.
2. Select the information to be included in the report and confirm with the **Next >** button.
3. Indicate the preferred storage location and file name for the report and confirm with the **Finish** button. The report will be created as a PDF file.

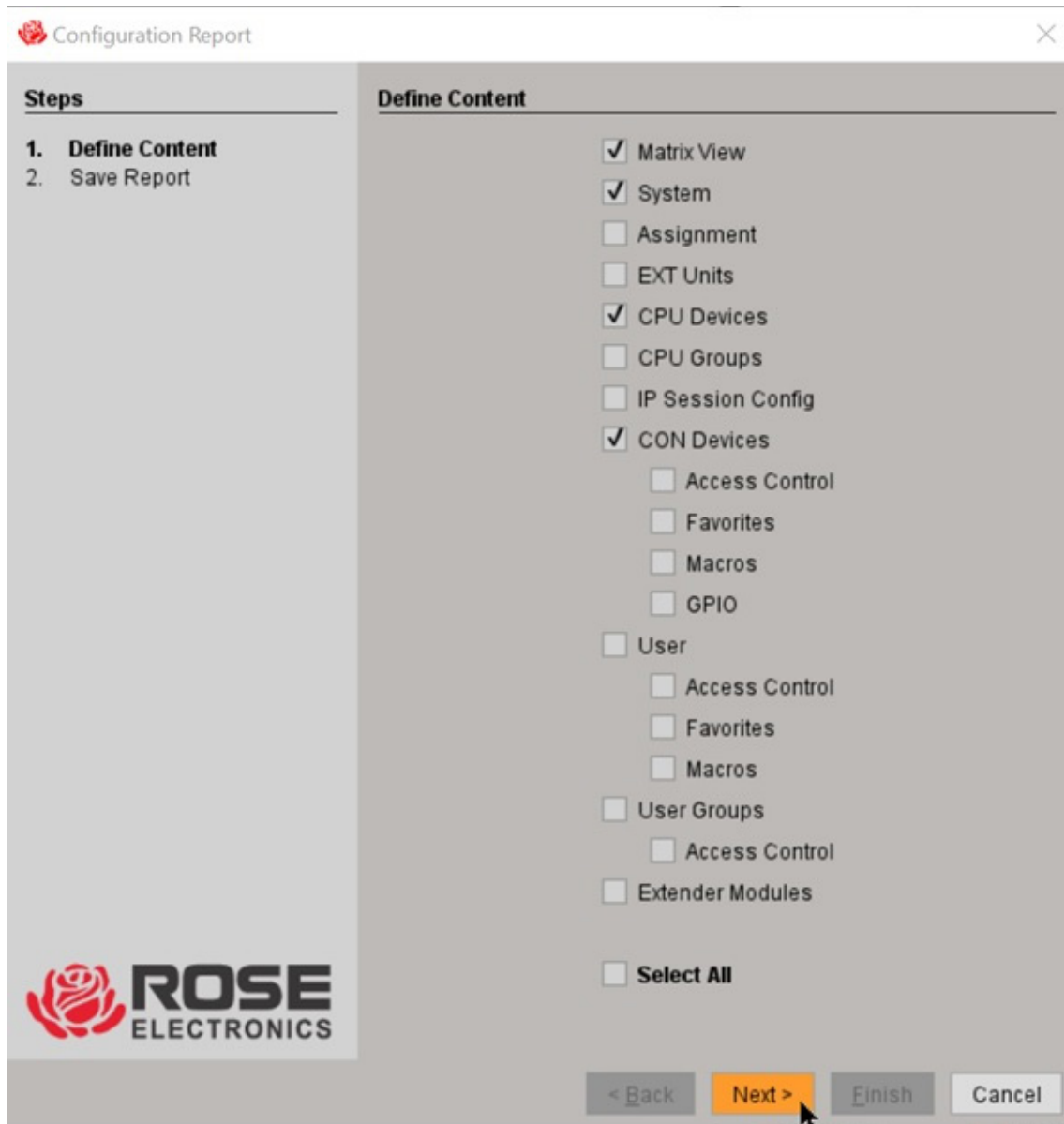

Figure 60. Java Tool Configuration Report

The report function can be used in both online mode and offline mode.

## Configuring System Settings

Orion FX system settings can be configured by administrators through either the OSD or the Java Tool.

### System Settings

The following settings can be modified.

Field	Selection	Description
<b>Device</b>	Text	Enter the device name of the matrix (default: SWITCH_01)
<b>Name</b>	Text	Enter the name of the configuration that is used to save the current settings (default: Standard)
<b>Info</b>	Text	Additional text field to describe the configuration (default: Factory settings)
<b>Sub Matrix</b>	Y	When Sub matrix is activated through the OSD, control of the OSD is automatically lost. Control can be recovered by re-opening the OSD, using the keyboard command for Sub matrix OSD: <hot key>, <s>, <o>.
	N	Function not active (default)
<b>Load Default</b>	Y	Loads the matrix with the default configuration after a restart or when powered on.
	N	Loads the matrix with the last saved configuration after a restart or when powered on (default)
<b>Auto Save</b>	Y	Save the current configuration of the matrix to flash memory every 10 minutes. <b>Note:</b> During saving of the configuration, the matrix will not be operational. Saving occurs if changes have been made to the configuration, or switching operations have been executed since the last save.
	N	Function not active (default)
<b>Enable COM Echo</b>	Y	Echo all switching commands in the matrix through the serial interface. <b>Note:</b> This function should be enabled when using a media controller through the serial interface.
	N	Function not active (default)
<b>Enable LAN Echo</b>	Y	Echo all switching commands in the matrix through the LAN connection. <b>Note:</b> This function should be enabled when using a media controller via LAN connection; and on the Master matrix when using stacking with two or more matrices.
	N	Function not active (default)
<b>Enable Redundancy</b>	Y	Automatically switch to the second link of a connected redundant CON unit if the primary link of a CPU unit is lost (default). <b>Note:</b> This must be activated: <ul style="list-style-type: none"> <li>• for a single Orion FX unit with redundant link connections,</li> <li>• in both Orion FX units in a fully redundant setup.</li> </ul>
	N	Function not active
<b>Synchronize</b>	Y	Synchronize the sub matrix according to the switch status of the master matrix.
	N	Function not active (default)
<b>Echo Only</b>	Y	Synchronize the matrix based on the echo of a second matrix. <b>Note:</b> This is a bidirectional synchronization where both matrices have to be configured to <b>Synchronize</b> with the <b>Master IP</b> of the other matrix.
	N	Function not active (default)

Field	Selection	Description
<b>Master IP Address</b>	Numerical	Set the network address of the master matrix (default value: 000.000.000.000)
<b>Invalid IO-Boards</b>	Y	Keep I/O boards with incorrect or invalid firmware online in the matrix. <b>Note:</b> To keep an I/O board with wrong or damaged firmware online in the matrix, the maintenance mode of the matrix will be activated.
	N	Shut down I/O boards with incorrect or invalid firmware automatically (default).
<b>Enable old Echo</b>	Y	Internally translate current switching commands (since V2.09) into the old switching commands and send them as an echo.
	N	Function not active (default)
<b>Remove IO-Boards</b>	Y	Orion X 576-port only: Shut down I/O boards in the Orion X 576 chassis if the second CPU board is not available. Connections will be disconnected
<b>Keep Gridlines</b>	Y	Keep gridlines connected while waiting for the grid master.
	N	Function not active (default)
<b>Horizontal Mouse Speed 1/x</b>	1-9	Adjust the horizontal mouse speed, 1 = slow, 9 = fast (default value: 4)
<b>Vertical Mouse Speed 1/x</b>	1-9	Adjust the vertical mouse speed, 1 = slow, 9 = fast (default value: 5)
<b>Double Click Time</b>	100-800	Specify the maximum time interval between 2 mouse clicks that will be recognized as a double click (default value: 200 ms)
<b>Keyboard layout</b>	Region	Set the OSD keyboard layout based on the keyboard in use
<b>Global Hot Key</b>	Hex number	Key used to enter command mode (default: 00, no global hot key)
<b>Global Fast Key</b>	Hex number	Key used to enter command mode and display the OSD (default: 00, no global Fast Key)

Table 14. System Data in the OSD

## Modifying System Settings through the OSD

- Select **Configuration** in the main menu and log in.
- Select **System** in the **Configuration** menu.

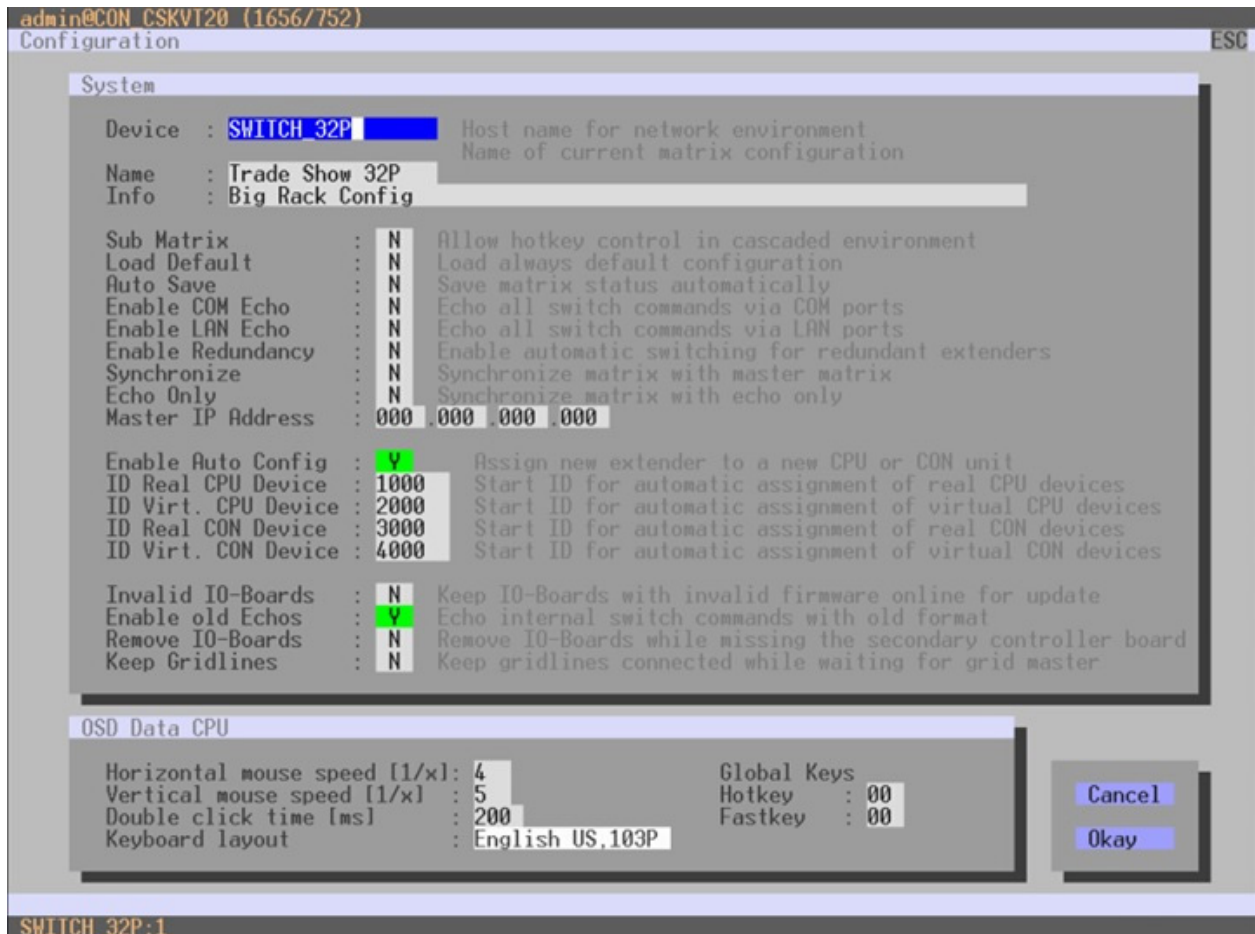

Figure 61. Modifying System Settings through the OSD

Any changes made must be confirmed or rejected by selecting between the following buttons:

Button	Function
Cancel	Reject changes
Okay	Save changes

Table 15. Buttons in the OSD System Screen

## Modifying System Settings through the Java Tool

➔ Select the **System Settings > System**.

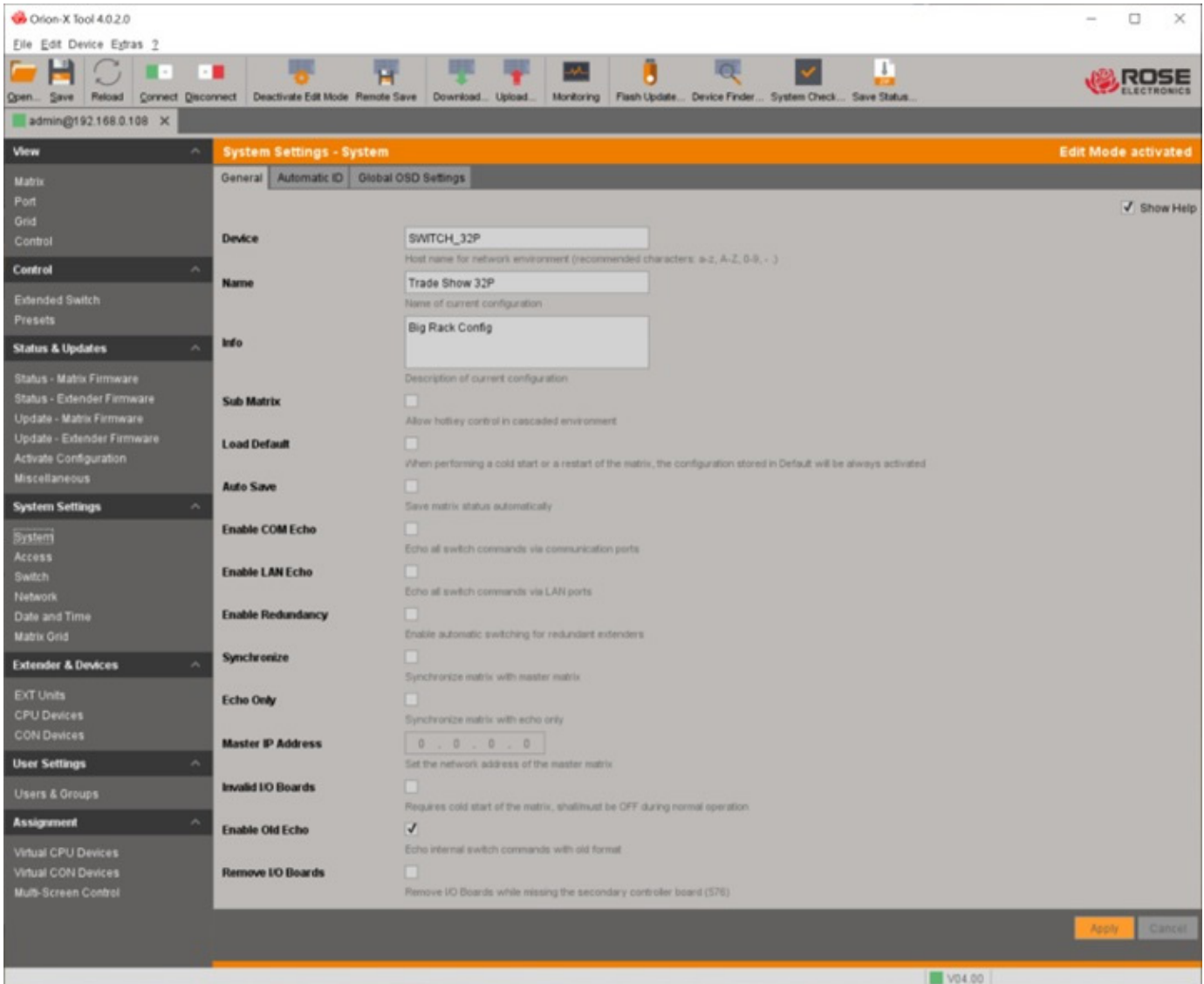

Figure 62. Modifying System Settings through the Java Tool

Make the necessary changes and click the **Apply** or **Cancel** buttons.

## Automatic ID

CPU and CON devices can be automatically created when a new extender unit is connected. This menu can be accessed in the OSD and the Java Tool.

Field	Selection	Description
<b>Enable Auto Config</b>	Y	Automatic creation of a new CPU or CON device when new extender modules are connected (default)
	N	Function not active
<b>ID Real CPU Device</b>	Numerical	Initial value of the automatic ID for real CPUs (default value: 1000)
<b>ID Virtual CPU Device</b>	Numerical	Initial value of the automatic ID for virtual CPUs (default value: 2000)
<b>ID Real CON Device</b>	Numerical	Initial value of the automatic ID for real CONs (default value: 3000)
<b>ID Virtual CON Device</b>	Numerical	Initial value of the automatic ID for virtual CONs (default value: 4000)

Table 16. Automatic ID Settings

### Modifying Automatic ID Settings through the OSD

→ Select **Configuration** in the main menu, log in, and select **System**.

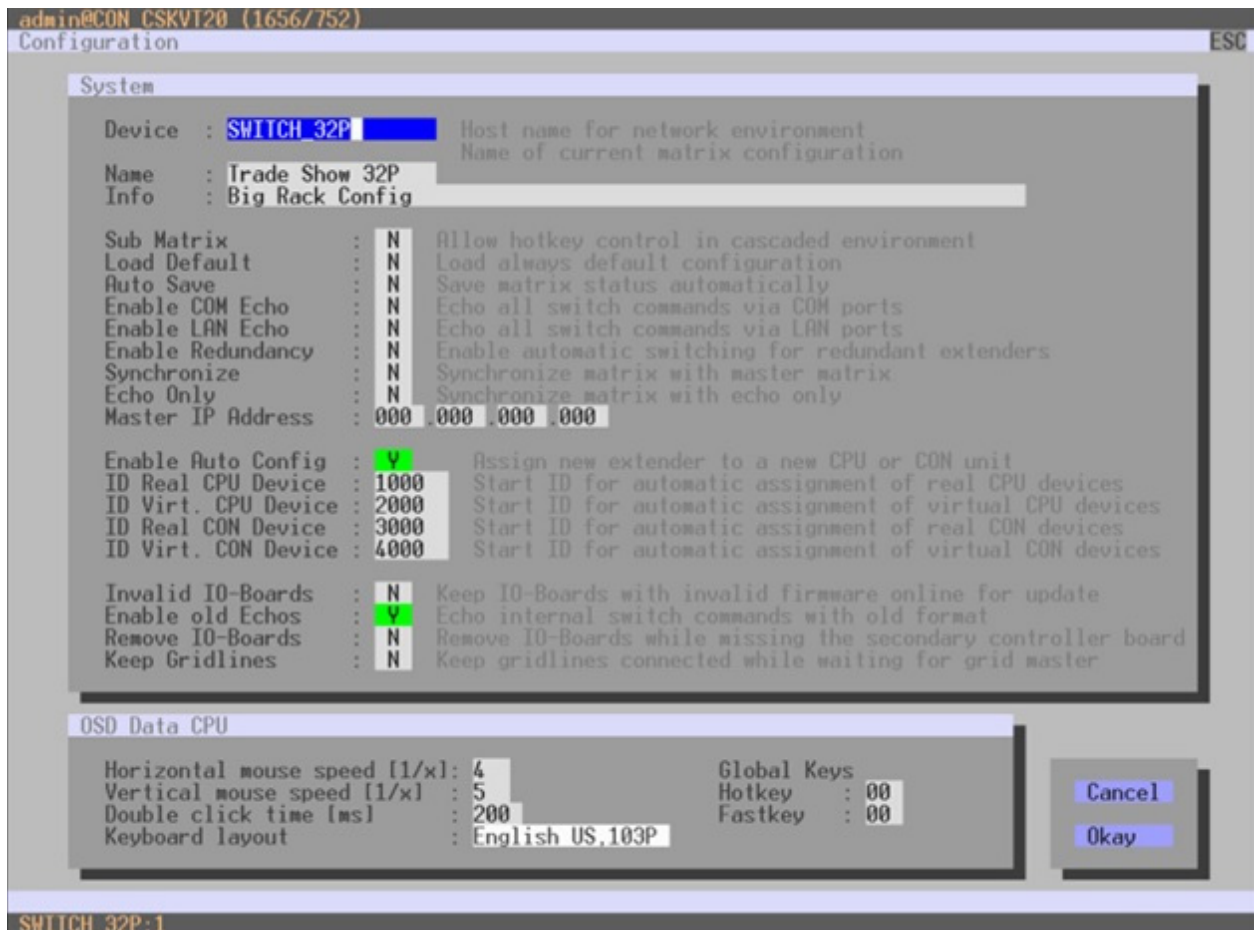

Figure 63. Modifying Automatic ID Settings through the OSD

Enable or disable **Auto Config**, and enter Start ID values, and select between the following buttons:

Button	Function
<b>Cancel</b>	Reject changes
<b>Okay</b>	Save changes

Table 17. Buttons in the OSD System Screen

## Modifying Automatic ID Settings through the Java Tool

➔ Select the **Automatic ID** tab in **System Settings > System**.

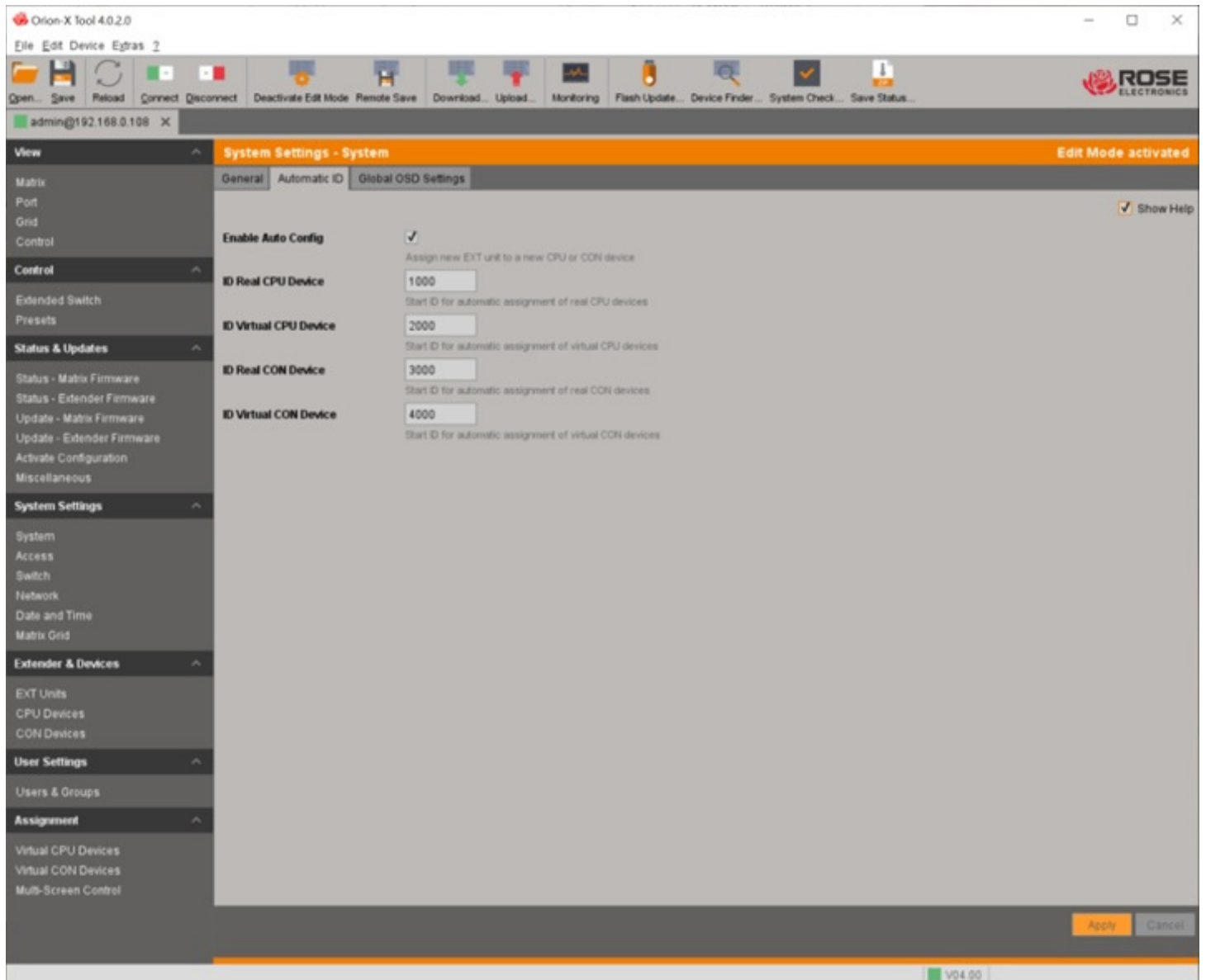

Figure 64. Modifying Automatic ID Settings through the Java Tool

Enable or disable **Auto Config**, enter Start ID values, and click the **Apply** or **Cancel** buttons.

## Global OSD Settings

Orion Hot Keys and Fast Keys can be assigned globally, as well as individually to each console extender. A Hot key puts the console into command mode. A Fast Key puts the console into command mode and displays the OSD. Valid values for the Hot Key and the Fast Key are the USB-HID keyboard scan codes for keyboards with the US layout. The selected key must be pressed once if it is a function key or the print key, and twice if it is any other key.

**Note:** Individual console extender assignments for Hot Key and Fast Key override global assignments.

Field	Selection	Description
<b>Hot Key / Fast Key</b>	00	No global Hot Key / Fast Key defined, no modification of the extender module
	01 to FE	Overwrite the Hot Key / Fast Key of the extender module with the entered value of the global Hot Key / Fast Key
	FF	Deactivate the Hot Key / Fast Key of the extender module

Table 18. Global OSD Settings

## Modifying Global Hot Key and Fast Key Settings through the OSD

→ Select **Configuration** in the main menu, log in, and select **System**

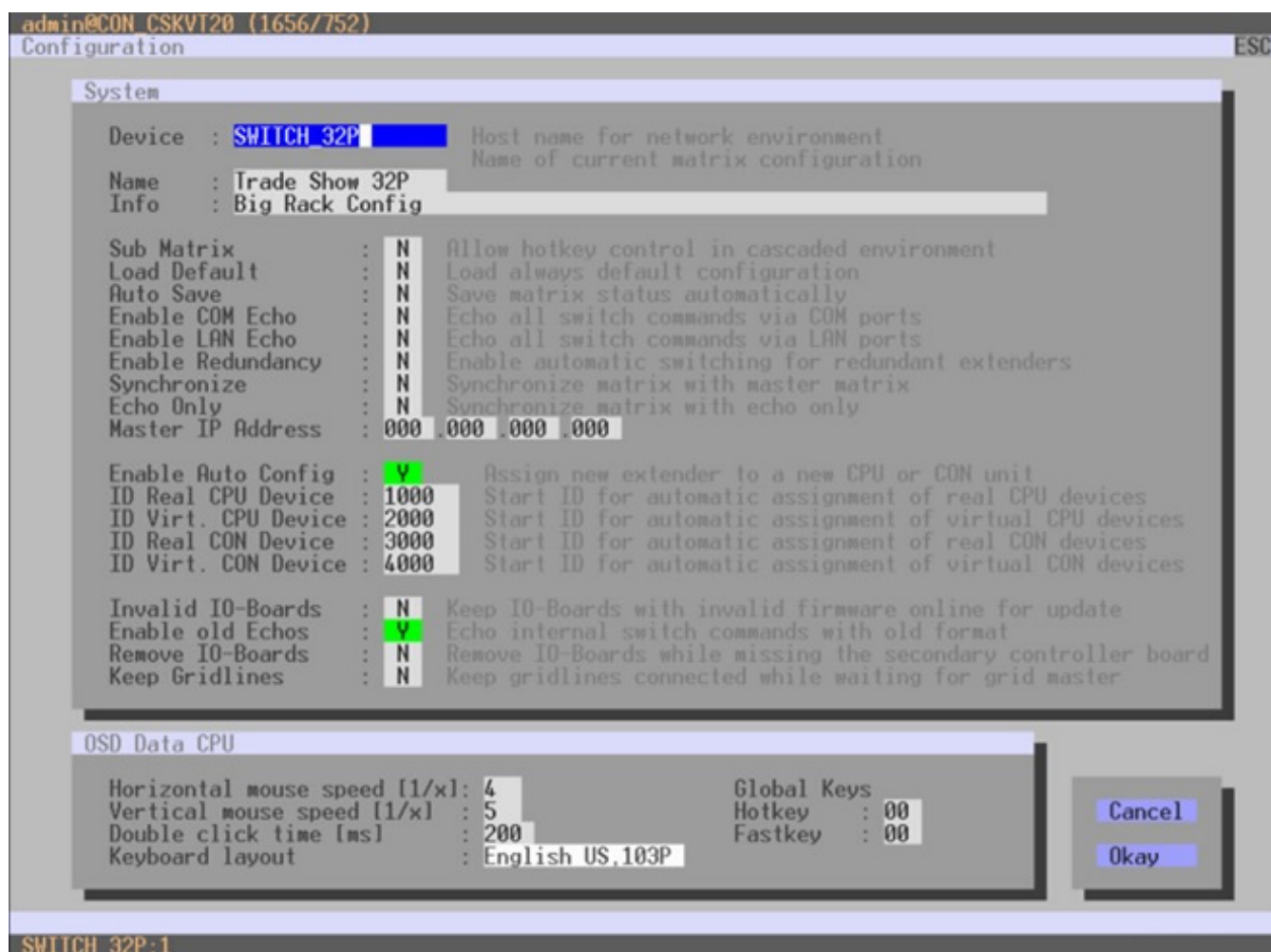

Figure 65. Global Hot Key and Fast Key settings in the OSD

Enter the desired values for Global Hotkey and Fastkey and select between the following buttons:

Button	Function
<b>Cancel</b>	Reject changes
<b>Okay</b>	Save changes

Table 19. OSD Save / Reject Selection Options

### Modifying Global Hot Key and Fast Key Settings through the Java Tool

- ➔ Select the **Global OSD Settings** tab in **System Settings > System**.
- ➔ Select the keys desired from the drop-down menus and click the **Apply** or **Cancel** buttons.

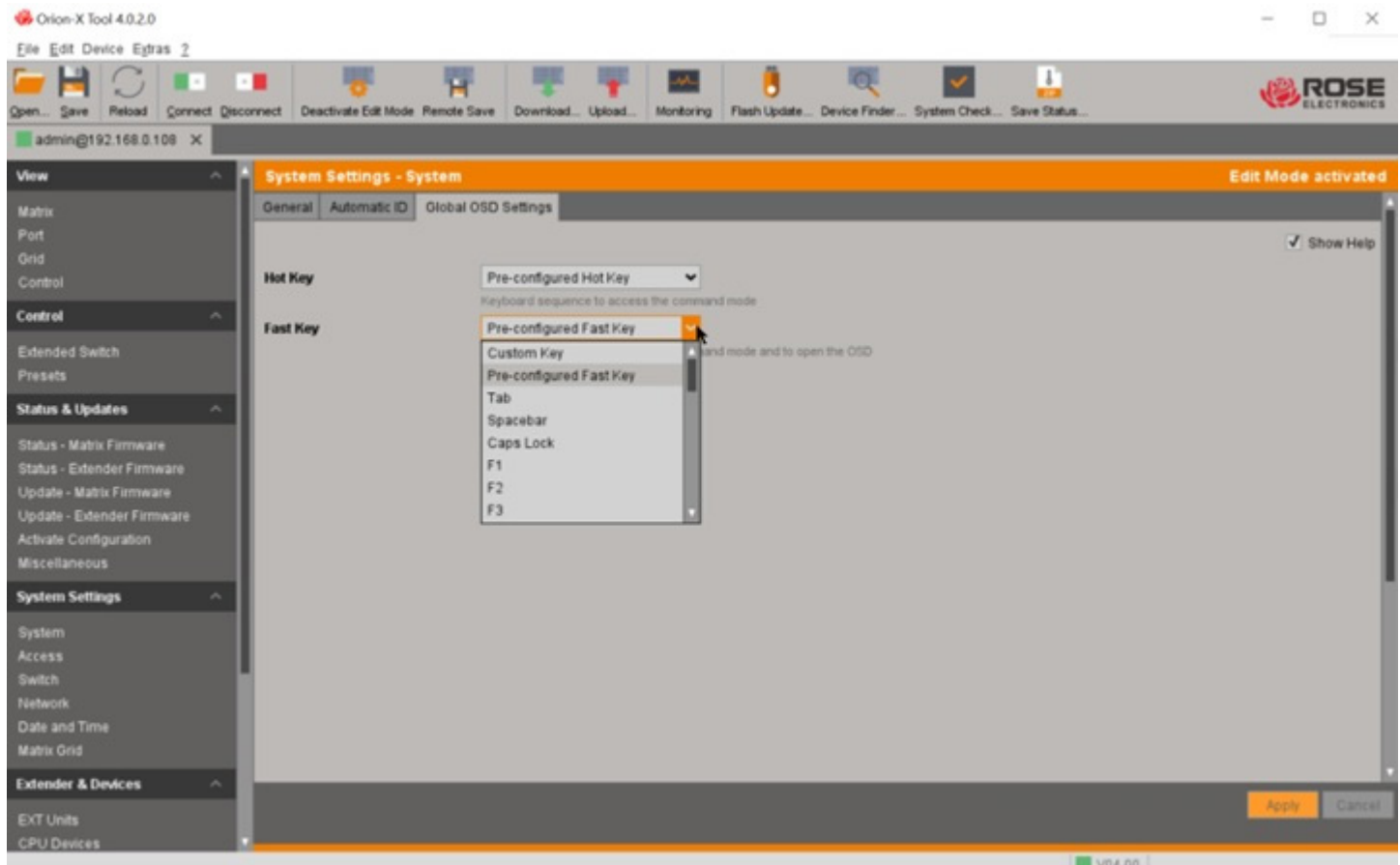

Figure 66. Global Hot Key and Fast Key Settings in the Java Tool

## Access Control

The access control configuration can be modified in the in the OSD and the Java Tool. The following settings can be modified.

Field	Selection	Description
<b>Force User Login</b>	Y	Users must login with a user name and a password once to enter OSD. Thereafter the user remains logged in until the user explicitly logs out or an auto logout occurs. <b>Note:</b> When using the <b>Force User Login</b> function, console favorites (see Console Favorites List) and console macros (see Console Macros) remain active.
	N	Function not active (default)
<b>Enable User ACL</b>	Y	CPU access is restricted according to the permissions in the User Access Control List. <ul style="list-style-type: none"> <li>▪ User login is required</li> <li>▪ Switching by keyboard 'Hot Keys' requires a prior login</li> </ul>
	N	Function not active (default)
<b>Enable CON ACL</b>	Y	CPU access is restricted according to the permissions in the Console Access Control List. No login required.
	N	Function not active (default)
<b>OR User/CON ACL</b>	Y	User's access rights are the sum of the User ACL and the Console ACL after logging in to a console (extended access)
	N	Function not active (default)
<b>AND User/CON ACL</b>	Y	User can only access equipment allowed in BOTH the User ACL and the Console ACL
	N	Function not active (default)
<b>Enable new User</b>	Y	Newly created users automatically receive access to all CPUs.
	N	Function not active (default)
<b>Enable new CON</b>	Y	Newly created CON devices automatically receive access to all CPUs.
	N	Function not active (default)
<b>Auto Disconnect</b>	Y	When the OSD is opened at a console its current CPU connection will be automatically disconnected.
	N	Function not active (default)
<b>OSD Timeout</b>	0-999 seconds	Period of inactivity after which OSD will be closed automatically. <ul style="list-style-type: none"> <li>▪ Select 0 seconds, for no timeout (default: 0 seconds)</li> </ul>
<b>Auto Logout</b>	0-999 minutes	Period of inactivity of a logged-in user at a console after which the user will be automatically logged out. The user's current connection may be disconnected as a result of the logout, depending on the access rights in the User and Console ACL. <ul style="list-style-type: none"> <li>▪ Select 0 minutes to disable inactivity logout.</li> <li>▪ Using the setting -1 allows the user to remain logged in until a manual logout is executed.</li> <li>▪ The timer is not active as long as the OSD is open.</li> </ul> (default: 0 minutes)
<b>Keep CPU</b>	Y	Keep the connection to the CPU device active in the background after Auto Logout. After a new login there is no need to re-connect to the CPU device.
	N	Function not active (default)

Field	Selection	Description
Show CPU	Y	Always show the name of the current CPU in the Connection Info box.
	N	Function not active (default)

Table 20. Access Control Settings

### Modifying Access Control through the OSD

- Select **Configuration** in the main menu and log in.
- Select **Access**.

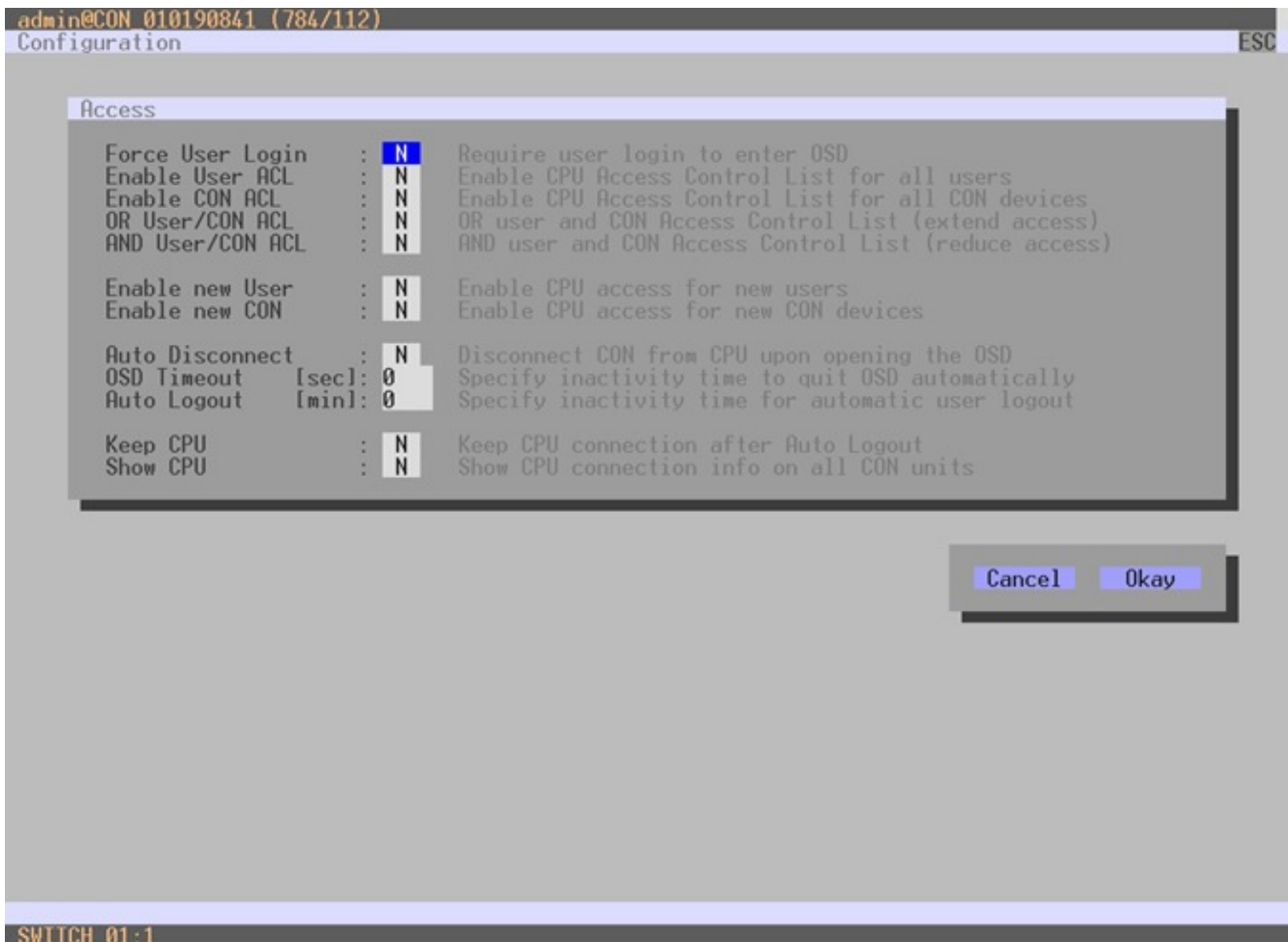

Figure 67. Modifying Access Control through the OSD

Select between the following buttons:

Button	Function
Cancel	Reject changes
Okay	Save changes

Table 21. Buttons in OSD Configuration Access Screen

## Modifying Access Control through the Java Tool

→ Select **System Settings > Access** in the task area.

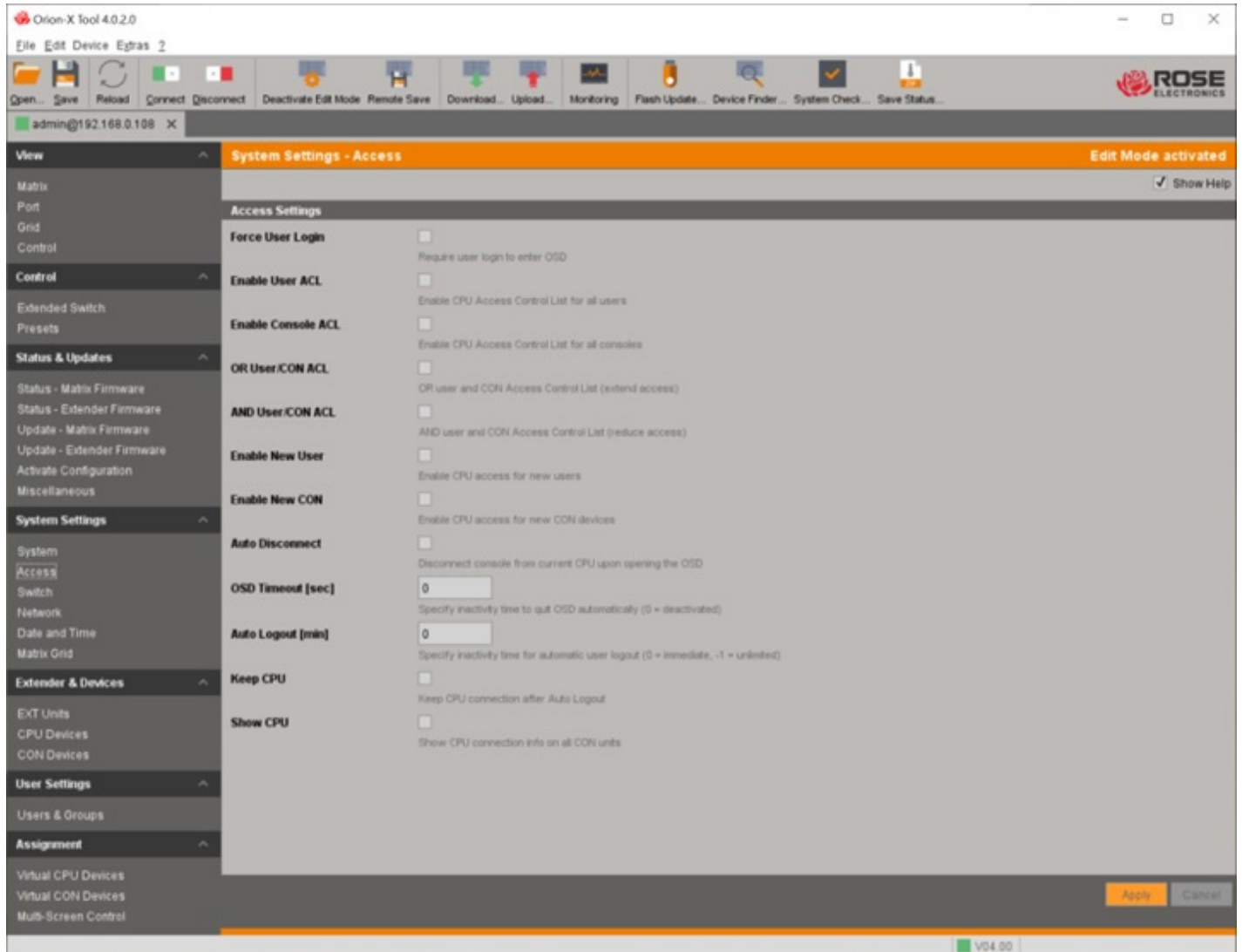

Figure 68. Modifying Access Control through the Java Tool

Make the necessary changes and click the **Apply** or **Cancel** buttons.

## Switch Settings

The configuration of the switching parameters is set in this menu. This menu can be accessed in the OSD and the Java Tool. The following settings can be modified.

Field	Selection	Description
<b>Enable Video Sharing</b>	Y	Users can switch to any CPU as an observer, even ones connected to another user (observers without keyboard or mouse control). <b>Note:</b> Switching as an observer is done with <Space>, not <Enter>. The current user must have <b>Update Connection Info</b> enabled for his CON EXT to be notified when another user connects.
	N	Function not active (default)
<b>Force Connect</b>	Y	Users can connect to any CPU with keyboard and mouse control, even ones with another user currently connected. <b>Note:</b> The previous user is changed to video only status. To share K/M control, <b>Force Connect</b> must be activated.
	N	Function not active (default)
<b>Force Disconnect</b>	Y	An extension of <b>Force Connect</b> : if users connect to a CPU which already has another user connected, that user will be disconnected. <b>Note:</b> To share K/M control, <b>Force Disconnect</b> must be deactivated.
	N	Function not active (default)
<b>CPU Auto Connect</b>	Y	If a console is not connected to a CPU, an automatic connection to the next available CPU can be established by pressing any key or clicking a mouse button.
	N	Function not active (default)
<b>CPU Timeout</b>	0-999 minutes	Period of inactivity after which a console will be automatically disconnected from its current CPU (default value: 0 minutes)
<b>Keyboard Connect</b>	Y	Activate request for K/M control by keyboard event (keystroke will be lost)
	N	Function not active (default)
<b>Mouse Connect</b>	Y	Activate request for K/M control by mouse event
	N	Function not active (default)
<b>Release Time</b>	0-999 seconds	Period of inactivity of a connected console after which K/M control can be requested by other consoles connected to the CPU (default: 10 seconds). <b>Note:</b> Setting "0" allows other users to immediately take control. Only one console can have keyboard and mouse control at a time. The other consoles that are connected to the same CPU have a video only status.
<b>Macro Single Step</b>	Y	Execute macros one command at a time
	N	Function not active (default)

Table 22. Switch Settings

To configure shared operation, proceed as follows:

1. Select **Configuration**, log in, and select **Switch** in the main menu.
2. Activate **Enable Video Sharing**.
3. Activate **Force Connect**.
4. Activate **Keyboard Connect**, if keyboard events should trigger taking control.
5. Activate **Mouse Connect**, if mouse events should trigger taking control.
6. Set a **Release Time** of inactivity after which KVM control can be taken.
7. Click the **Okay** button to confirm the settings.

**Note:** **Keyboard Connect** and/or **Mouse Connect** are only effective if **Force Connect** and/or **CPU Auto Connect** are enabled. If the **Keyboard Connect** and/or **Mouse Connect** options are activated, a current user must be inactive for the number of seconds specified by **Release Time** before a new user can gain control.

## Modifying Switch Settings through the OSD

→ In the main menu select **Configuration**, log in, and select **Switch**.

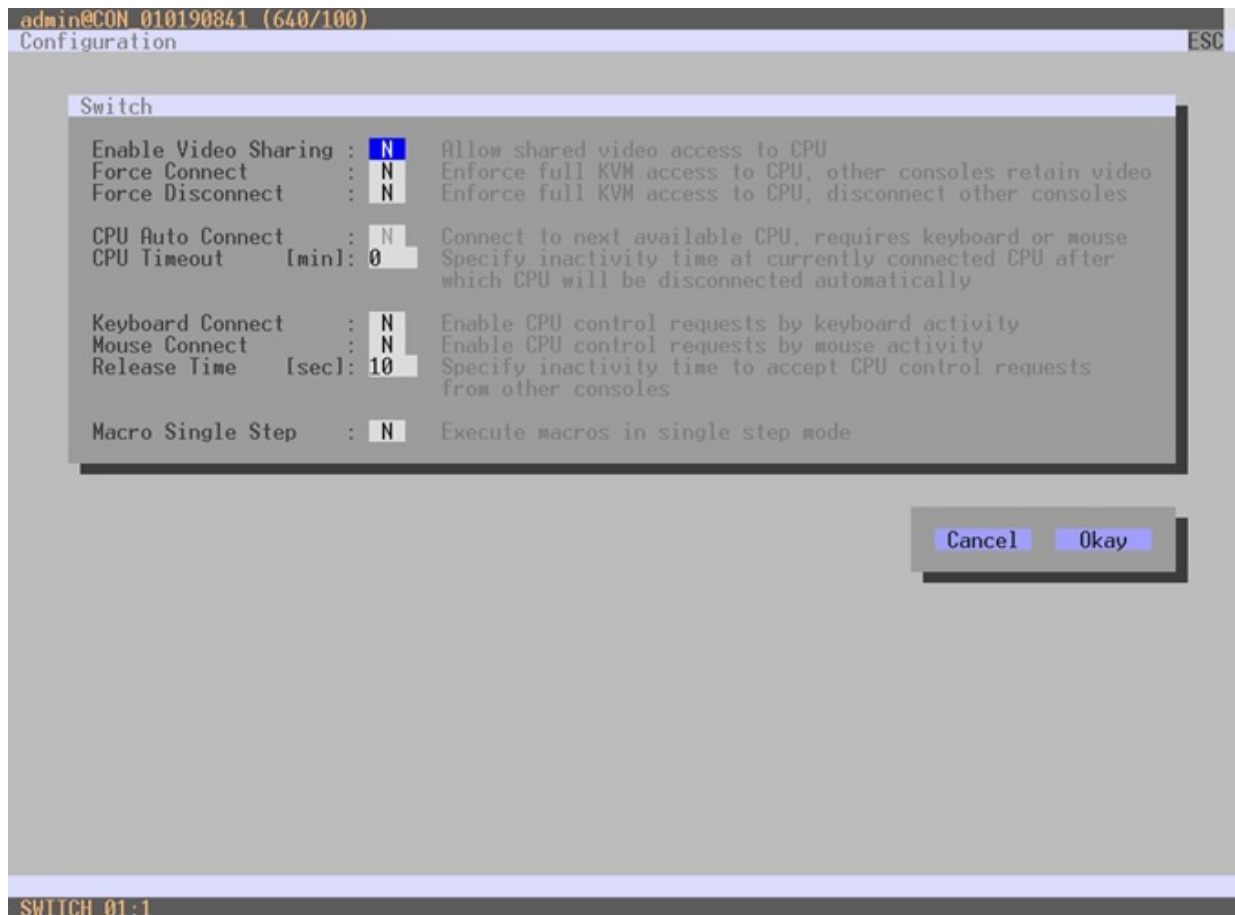

Figure 69. Modifying Switch Settings through the OSD

Make the necessary changes and select between the following buttons:

Button	Function
Cancel	Reject changes
Okay	Save changes

Table 23. Buttons in OSD Switch Settings Screen

## Modifying Switch Settings through the Java Tool

➔ Select **System Settings > Switch** in the task area.

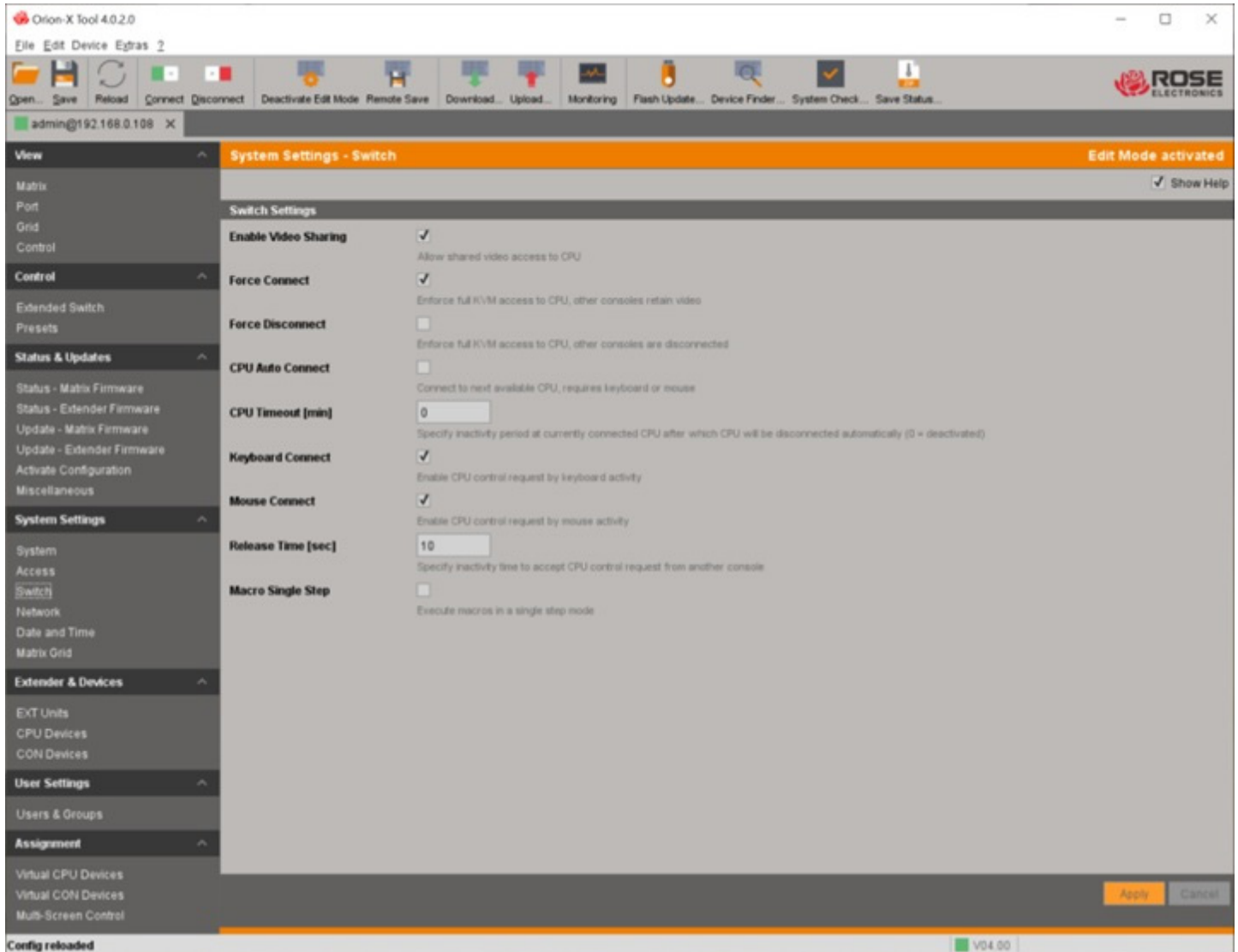

Figure 70. Modifying Switch Settings through the Java Tool

Make the necessary changes and click the **Apply** or **Cancel** buttons.

## Network Configuration

The following Network settings can be modified through the OSD and the Java Tool.

Field	Selection	Description
<b>Dual Interface</b>	Y	Disable redundant network interface
	N	Redundant network interface is active (default)
<b>DHCP</b>	Y	Network settings are automatically supplied by a DNS server <b>Note:</b> If DHCP is activated and there is no network connection, matrix boot time might increase.
	N	Function not active (default)
<b>IP address</b>	Byte	Enter the IP address to be used when DHCP is inactive (default: 192.168.100.99).
<b>Subnet Mask</b>	Byte	Enter the subnet mask to be used when DHCP is inactive (default: 255.255.255.0).
<b>Gateway</b>	Byte	Enter the gateway address to be used when DHCP is inactive, in the form "192.168.1.1".
<b>Multicast</b>	Byte	For Matrix Grids with a Multicast group, input the Multicast address (default: 255.255.255.0).
<b>API Service #1</b>	Y	LAN interface of Orion FX activated for access via Java Tool, API service port 5555/5565 (default).
	N	Function not active
<b>Grid Service #1</b>	Y	Activate Grid Service Port 5557/5567 of Orion FX for access via Java Tool,
	N	Function not active (default)
<b>SSL Services #1</b>	Y	Activate SSL encryption for API, Java Tool, and Matrix Grid communication
	N	Function not active (default)
<b>Syslog #1/#2</b>	Y	Enable Syslog server for status request messages
	N	Function not active (default)
<b>Syslog Server #1/#2</b>	Byte	Enter the Syslog server's IP address in the form "192.168.1.1" and the Syslog port (default: 514)
<b>LDAP</b>	Y	Enable user authentication with Active Directory Server
	N	Function not active (default)
<b>LDAP TLS/SSL</b>	Y	Enable transport layer security for Active Directory requests
	N	Function not active (default)
<b>LDAP Server</b>	Byte	Enter the IP address of the LDAP server (in the form "192.168.1.1"), and the LDAP port (Default: 389)
<b>LDAP Base DN</b>	Text	Enter the LDAP Base DN per the existing structure of the user directory
<b>Trace DEB</b>	Y	Activate debug messages in Trace (default: N) <b>Note:</b> Debug messages are exclusively for matrix diagnostics. They should be activated only after consultation with Rose Electronics, or increased data traffic might limit performance.
	N	Function not active (default).
<b>Trace INF</b>	Y	Activate information messages in Trace
	N	Function not active (default).
<b>Trace NOT</b>	Y	Activate notification messages in Trace (default).
	N	Function not active.
<b>Trace WAR</b>	Y	Activate warning messages in Trace (default).
	N	Function not active.

Field	Selection	Description
<b>Trace ERR</b>	Y	Activate error messages in Trace (default).
	N	Function not active.
<b>Syslog #1/#2 DEB</b>	Y	Activate debug messages in Syslog. <b>Note:</b> Debug messages are exclusively for matrix diagnostics. They should be activated only after consultation with Rose Electronics, or increased data traffic might limit performance of the Orion FX.
	N	Function not active (default).
<b>Syslog #1/#2 INF</b>	Y	Activate information messages in Syslog.
	N	Function not active (default).
<b>Syslog #1/#2 NOT</b>	Y	Activate notification messages in Syslog (default).
	N	Function not active.
<b>Syslog #1/#2 WAR</b>	Y	Activate warning messages in Syslog (default).
	N	Function not active.
<b>Syslog #1/#2 ERR</b>	Y	Activate error messages in Syslog (default).
	N	Function not active.

**Table 24. Network Settings**

If changes are made to network parameters, save the changes and restart Orion FX to activate the changes. Restarting the Orion FX can take several minutes and the system will be unavailable during the restart.

**Note:** Consult your system administrator before modifying the network parameters. Otherwise, unexpected results and failures may occur in combination with the network.

#### Network Ports Used by Orion FX

The following ports are used by Orion FX, depending on the configuration. Ports which are to be utilized for functions must be not be blocked by network security.

Function	Port
FTP	21 / TCP
DNS	53
SNTP	123 / UDP
SNMP	161, 162 / UDP
LDAP	389
Syslog	514 / UDP
API	5555 / TCP (5565 for SSL)
Broadcast	5556 / UDP (5566 for SSL)
Matrix Grid	5557 / TCP (5576 for SSL)

**Table 25. Orion FX Network Ports**

## Modifying Network Settings through the OSD

→ Select **Configuration** in the main menu, log in, and select **Network** in the Configuration menu.

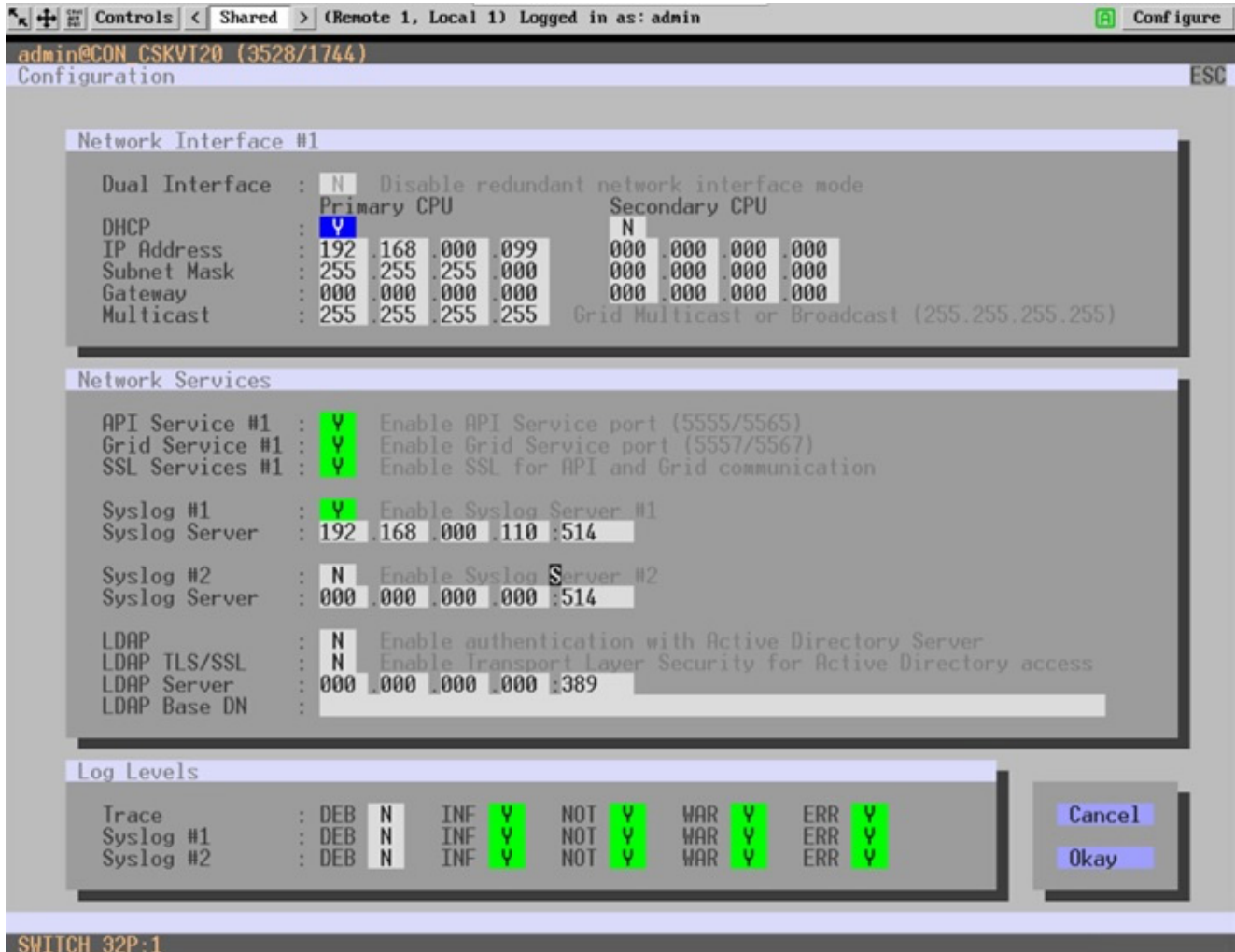

Figure 71. Modifying Network Settings through the OSD

Select between the following buttons:

Button	Function
Cancel	Reject changes
Okay	Save changes

Table 26. Buttons in the OSD Network Settings Screen

## Modifying Network Configuration through the Java Tool

➔ Select **System Settings > Network** in the task area.

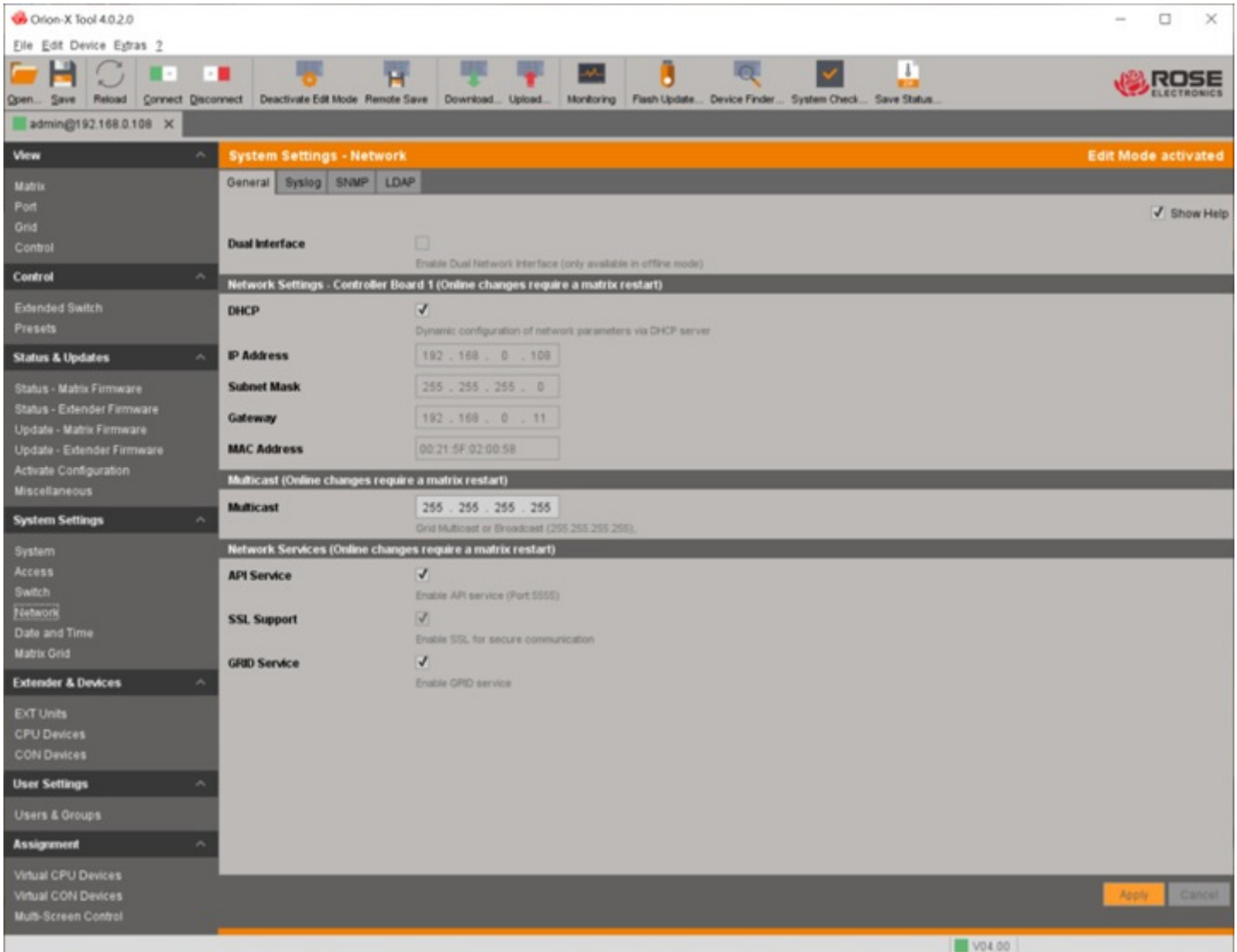

Figure 72. Modifying Network Settings through the Java Tool

Make the necessary changes and click the **Apply** or **Cancel** buttons.

## Activating Syslog

Starting or stopping the Syslog function is done with this Java Tool menu. The following parameters can be configured:

Field	Selection	Description
<b>Enable Syslog</b>	Activated	Enable Syslog service
	Deactivated	Function not active (default)
<b>Syslog Server</b>	Byte	Enter the IP address of the Syslog servers in the form "192.168.1.1"
<b>Log Level</b>	Debug	Activate debug messages in syslog (default: deactivated) <b>Note:</b> Syslog debug messages are for diagnostics only, not normal operation.
	Info	Activate information messages in syslog (default: deactivated)
	Notice	Activate notification messages in syslog (default: activated)
	Warning	Activate warning messages in syslog (default: activated)
	Error	Activate error messages in syslog (default: activated)

Table 27. Java Tool Syslog Settings

1. Select System Settings > Network in the task area.
2. Select the Syslog tab in the working area.
3. Make the desired changes to the settings and click Apply to confirm.

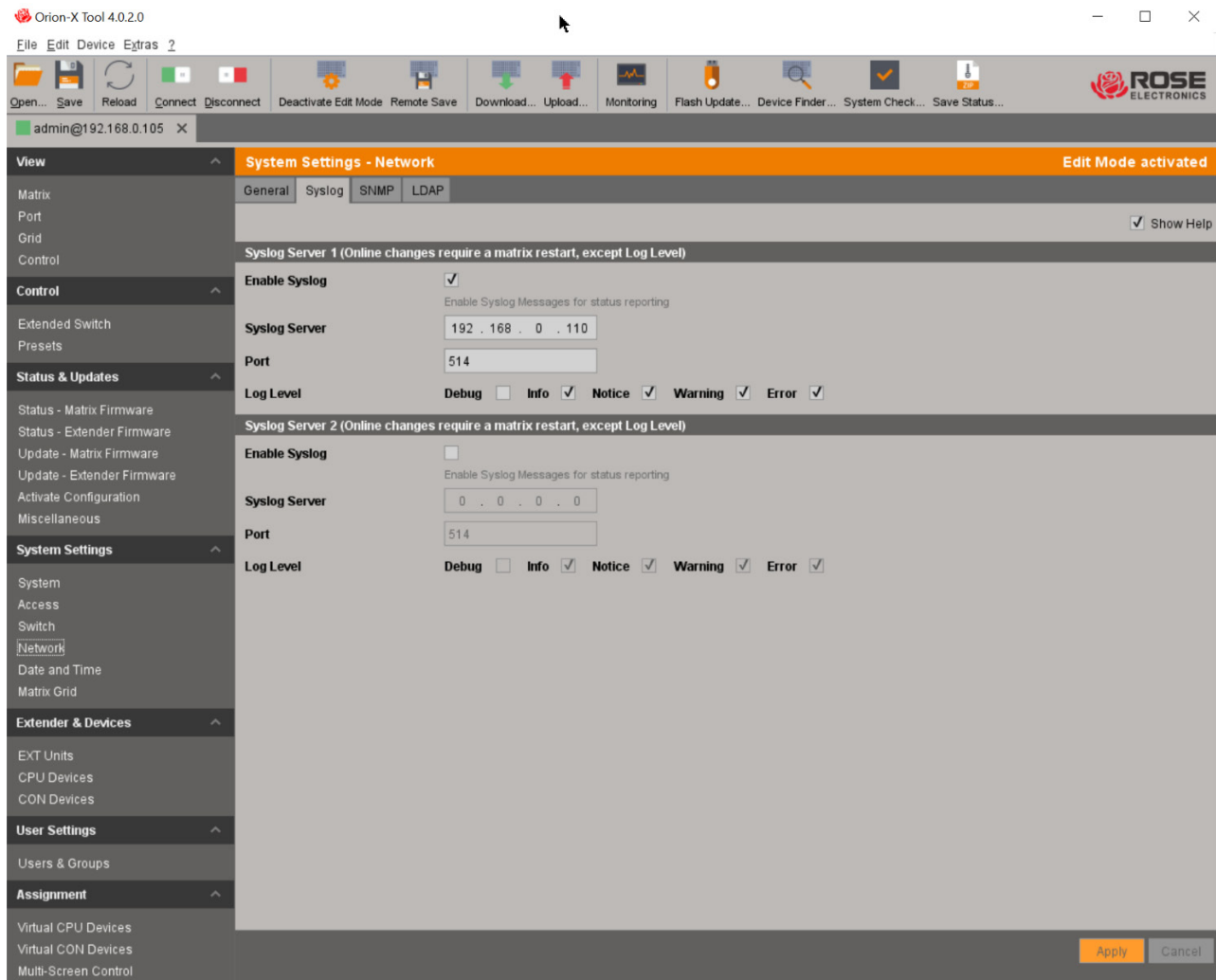

Figure 73. Syslog Activation

## Syslog Options

The following Syslog settings can be modified:

Option	Description
<b>Port</b>	The computer port used to transmit messages via UDP
<b>Log File Directory</b>	Default directory for log file storage
<b>Log File Name</b>	Default log file name
<b>Log File Extension</b>	Default log file extension
<b>Daily Log Files</b>	Log files are stored every 24 hours
<b>Maximum Log File Size, KB</b>	Maximum allowed size of log files
<b>Maximum number of Log Files</b>	Maximum number of log files allowed.
<b>Acoustic Notification</b>	Enable acoustic notification for errors.
<b>Autostart</b>	When the Java Tool software is started, the syslog function is started in the background
<b>Open Monitoring Tab</b>	When the Java Tool software is started, the monitoring tab is opened.

Table 28. Syslog Options

**Note:** When the maximum log file size is reached, a new log file will be created. When the maximum number of log files is reached, the oldest will be overwritten.

1. Select **Extras > Options** in the menu bar and open the **Syslog** tab.

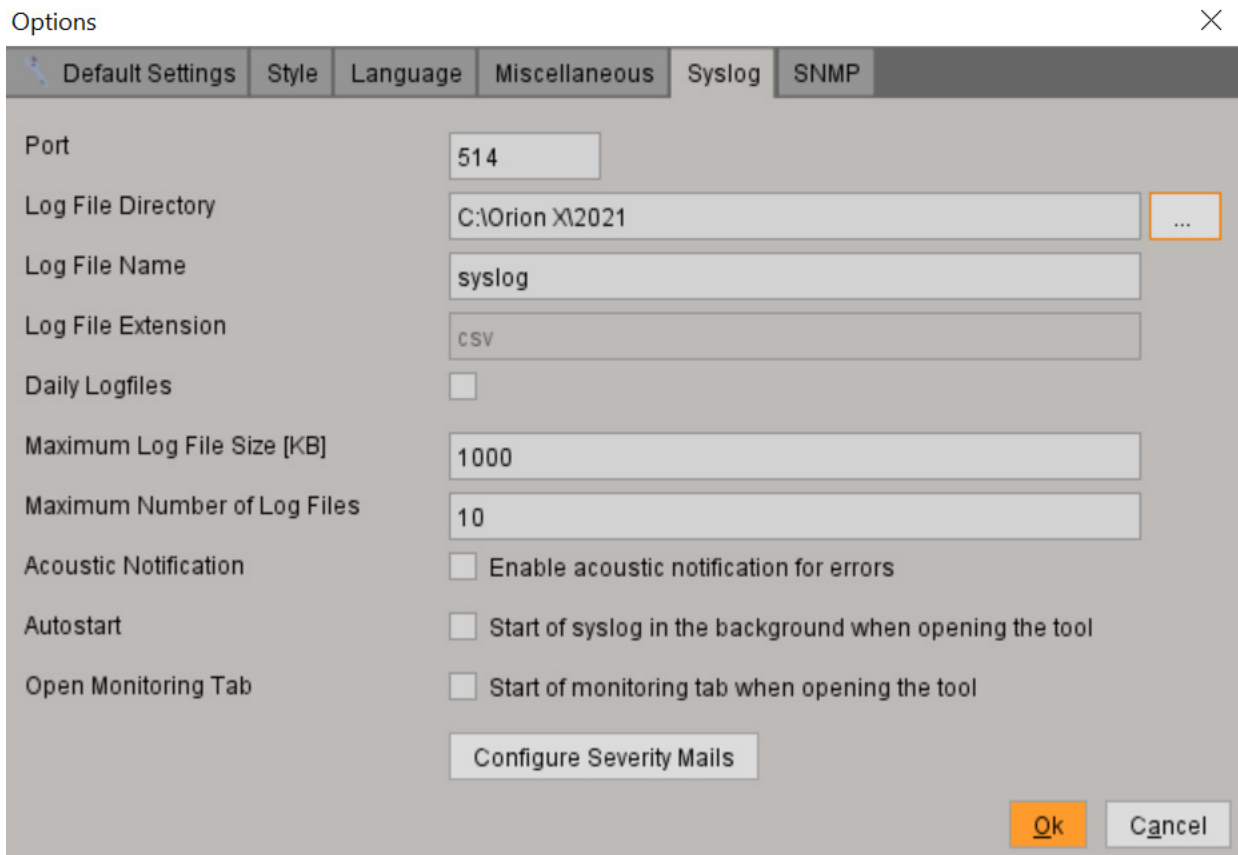

Figure 74. Syslog Options Tab in the Java Tool

2. Enter the appropriate information and click the **Ok** button to confirm.
3. Close the Java Tool software and restart it.

## Active Directory

The Orion FX matrix can be synchronized with Active Directory for user authentication. This allows users to log in to Orion FX with login information from the Active Directory server. The connection between Orion FX and the Active Directory server is established via OpenLDAP and synchronized every 5 minutes.

The search for users to be synchronized and automatically added to the KVM matrix configuration can be based on a **group** or an **organizational unit (OU)**. In either case a user must be at least assigned to one group.

With the **group** approach, all users belonging to a defined group in the active directory server are added to the KVM matrix and synchronized. The organizational units are added to the Orion FX configuration as user groups. This means that the group that includes the user can be found as an Orion FX user group in the configuration after the synchronization. A user can be member of up to 8 groups.

With the **organizational unit (OU)** approach, all users belonging to groups that are located directly under this organizational unit are added and synchronized. The groups can also include subgroups. The structure of the groups is added to the Orion FX configuration as user groups. Each group will be represented in the KVM matrix as a user group after the synchronization. Groups located in sub organizational units are ignored.

The integration of Active Directory is only available with the newer controller boards.

The following parameters can be configured:

Field	Selection	Description
<b>LDAP</b>	Y	LDAP for user verification is active
	N	Function not active (default)
<b>TLS/SSL</b>	Y	Enable secure transmission (transport layer security) for Active Directory access
	N	Function not active
<b>LDAP Server</b>	Byte	The IP address of the LDAP Server, in the form "192.168.1.1", and the LDAP port (Default: 389/636)
<b>Configured LDAP User</b>	Text	Name of the configured LDAP user
<b>LDAP Base DN</b>	Text	Input of the LDAP Base DN according to the existing structure of the user directory

Table 29. Active Directory Parameters

## Configuration of Active Directory Server Synchronization with the OSD

In the OSD, LDAP is configured in two menus: **Network** and **User Data**.

→ Select **Configuration** in the main menu and log in.

→ Select **Network**.

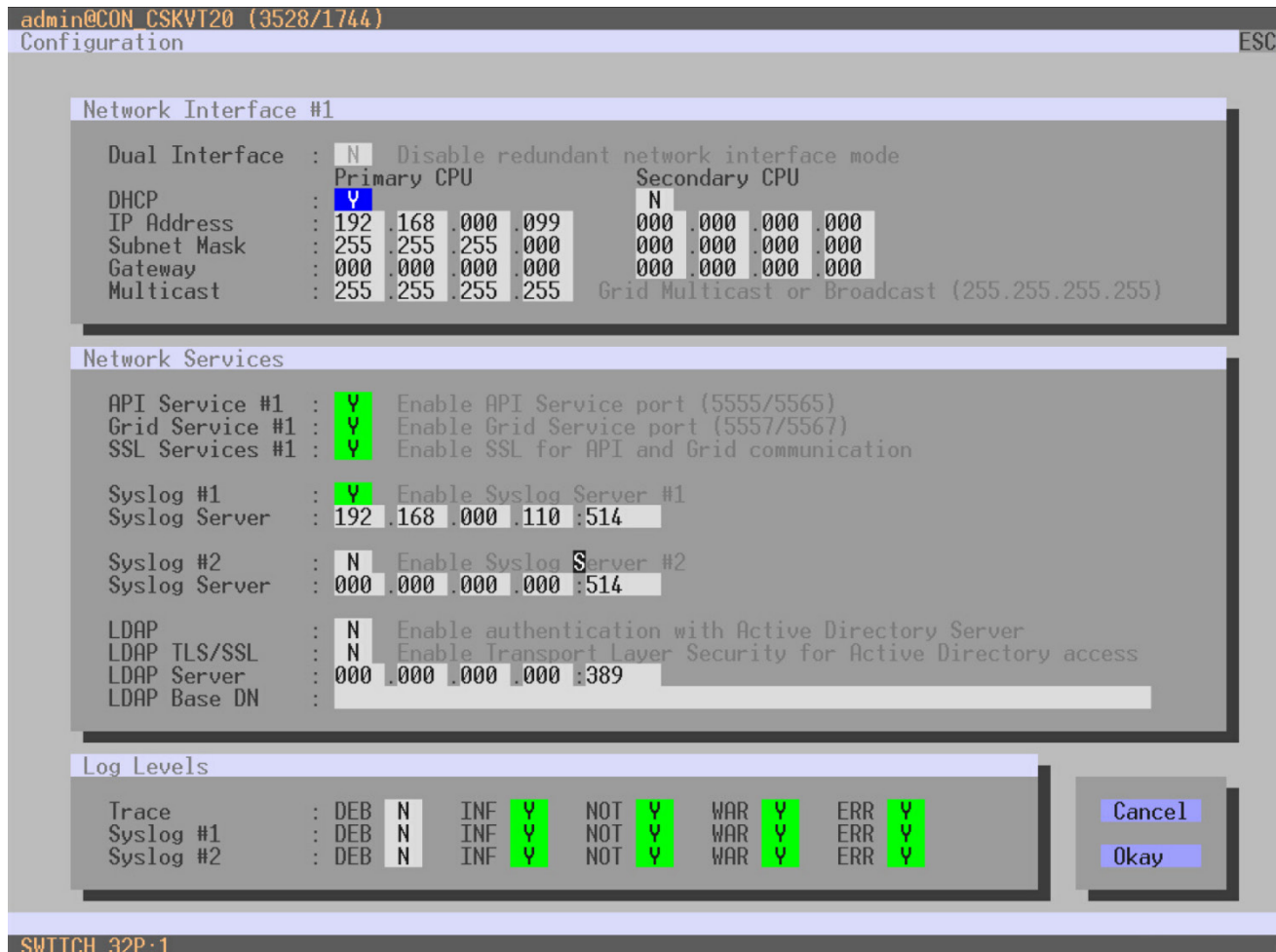

Figure 75. Network Settings for Active Directory with the OSD

1. In the Network Services section, activate at least the function **LDAP**, and optionally **LDAP TLS/SSL**.
2. Enter the appropriate IP address and port number in the field **LDAP Server** (default port: 389, 636 for SSL).
3. Enter the appropriate information into the field **LDAP Base DN** (e.g., dc=example, dc=com).
4. Click **Okay** to save the changes.
5. Restart the Orion FX for the changes to take effect.
6. When Orion FX has rebooted, select **Configuration** in the Main menu and log in.
7. Select **User Data**.

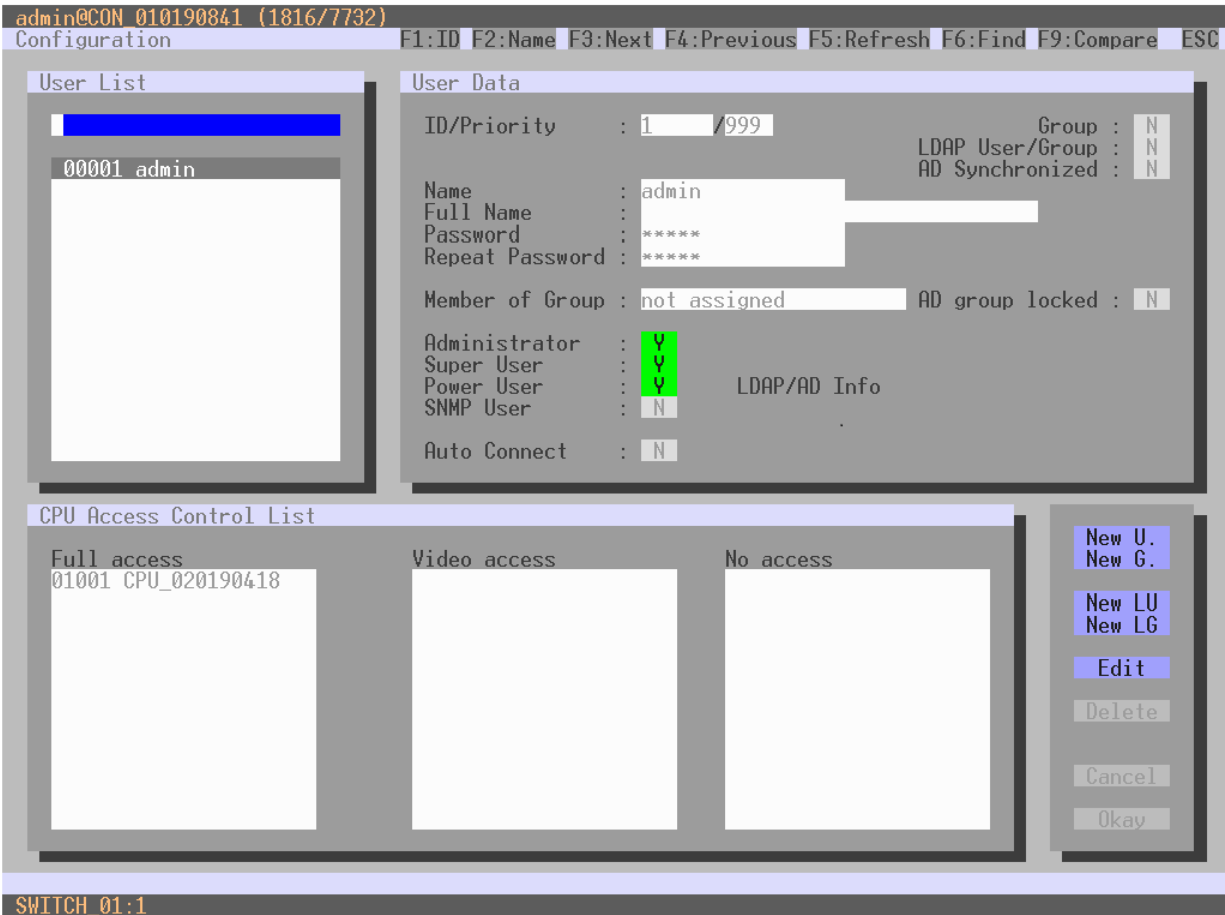

Figure 76. Active Directory Configuration with the OSD

8. Click the **New LU** button to create a new LDAP user. This user functions as a bind user.
9. Enter the name of the bind user from the Active Directory into the **Name** field.
10. Enter the Common Name (CN) of the bind user into the **Login Name** field.
11. Enter the password of the bind user from the Active Directory into the fields **Password** and **Repeat Password**.
12. Confirm the creation of the user by clicking the **Okay** button.
13. Now click the **New LG** button to create a new LDAP group. The group determines which users of the Active Directory server should be synchronized.
14. Enter a name into the **Name** field.
15. Enter either Common Name (CN) of a group or the Common Name of an organizational unit into the field **LDAP OU=/CN=** in the form "OU=" name of the organizational unit, or "CN=" name of the group. The field entry must include either "OU=" or "CN=".
16. Confirm the creation of the group by clicking the **Okay** button.

Active Directory synchronization can now be used.

**Note:** A matrix configuration should only include one LDAP user and one LDAP group at the same time. The LDAP user and the LDAP group can be created, changed or deleted during ongoing operation without restarting the Orion FX.

## Configuration of Active Directory Server Synchronization with the Java Tool

1. Select **System Settings > Network** in the task area.
2. Select the LDAP tab in the working area.

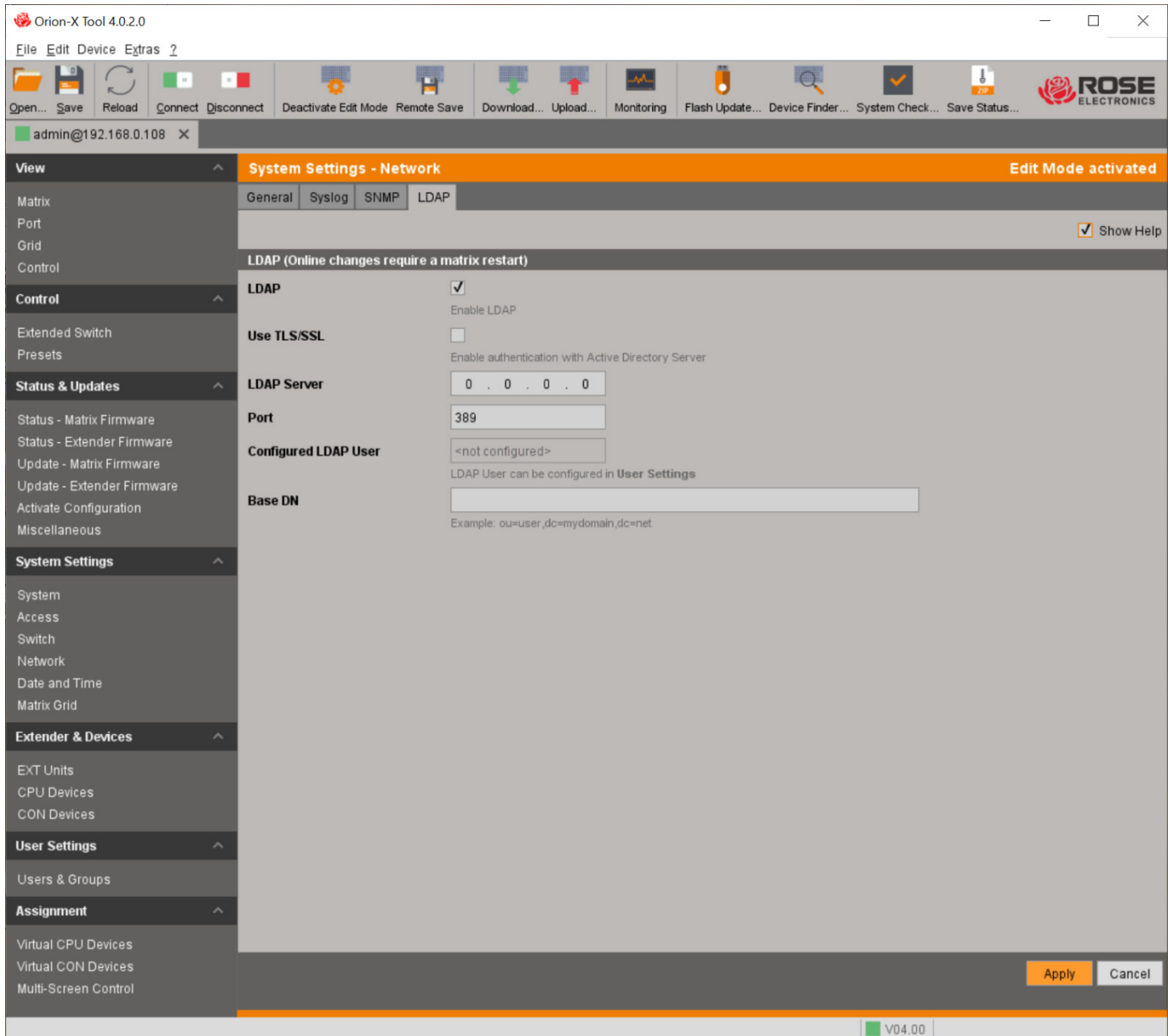

Figure 77. Active Directory Setup with the Java Tool

3. Click the **LDAP** checkbox.
4. Optionally click the **Use TLS/SSL** checkbox to activate those functions.
5. Enter the server IP address and port number into the fields **LDAP Server** and **Port** (default port: 389, 636 for SSL).
6. Enter the LDAP Base DN into the field **Base DN** (e.g. dc=example, dc=com).
7. Click the **Apply** button to save the changes, and restart the Orion FX for the changes to take effect.

8. Select **User Settings > Users & Groups** in the task area.

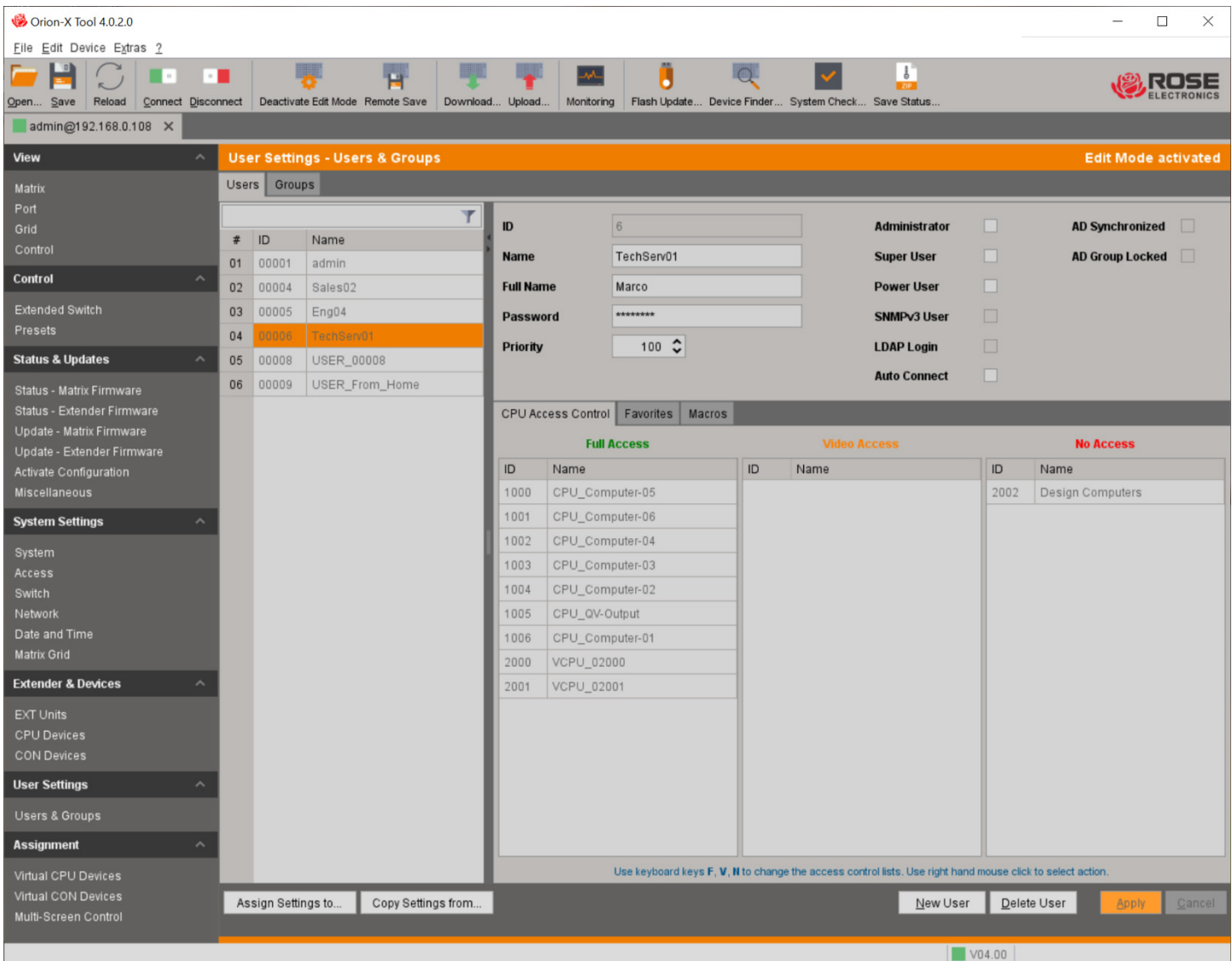

Figure 78. Creating a User for Active Directory with the Java Tool

9. Click the **New User** button.

10. Select **Create a LDAP User** in the pop-up window and click the **OK** button.

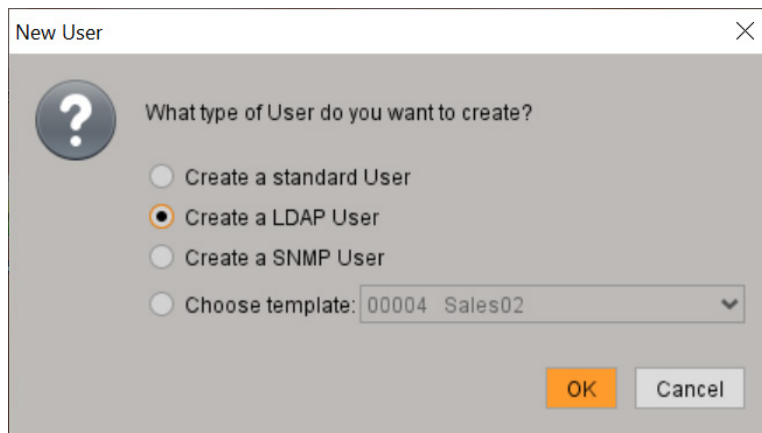

Figure 79. Create an LDAP User in the Java Tool

11. Enter the name of the bind user from the Active Directory in the **Name** field.
12. Enter the Common Name (CN) of the bind user from the Active Directory into the **Login Name** field.
13. Enter the password of the bind user from the Active Directory into the field **Password** and confirm it.
14. Confirm the creation of the user by pressing the button **Apply**.
15. Open the tab **Groups**.
16. Click the **New Group** button to create a new LDAP group.

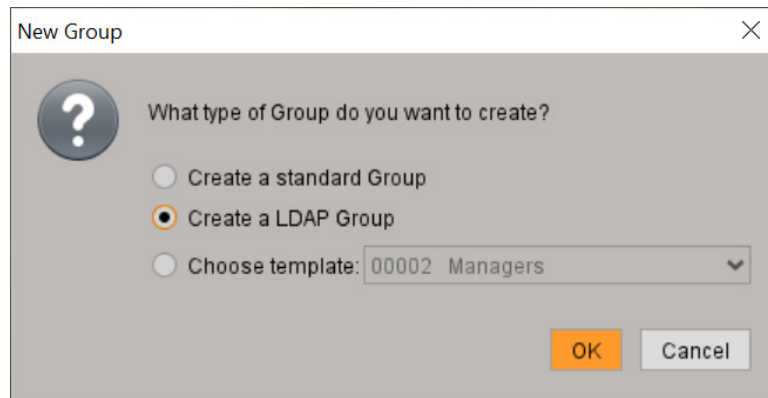

Figure 80. Create a new LDAP Group with the Java Tool

17. Select **Create a LDAP Group** in the pop-up window. The group determines which users of the Active Directory server should be synchronized.
18. Enter a name into the **Name** field.
19. Enter either the Common Name (OU) of an organizational unit or the Common Name (CN) of a right group into the field **LDAP OU=/CN=** as shown below:
  - a. OU= name of the organizational unit
  - b. CN= name of the right group
20. Confirm the creation of the user by clicking the **Apply** button.

Active Directory synchronization can now be used.

## SNMP

The SNMP function allows all function-critical and safety-critical elements of the matrix to be monitored and queried. This function complies with the RFC 1157 standard. The SNMP option can be configured with the OSD and the Java Tool.

**Note:** When using SNMP monitoring, the use of a dedicated network to maintain continuous access is strongly recommended.

### SNMP Configuration with the OSD

To enable SNMP and configure a SNMP server with the OSD, proceed as follows:

1. Select **Configuration** in the main menu and log in.
2. Select **SNMP**.

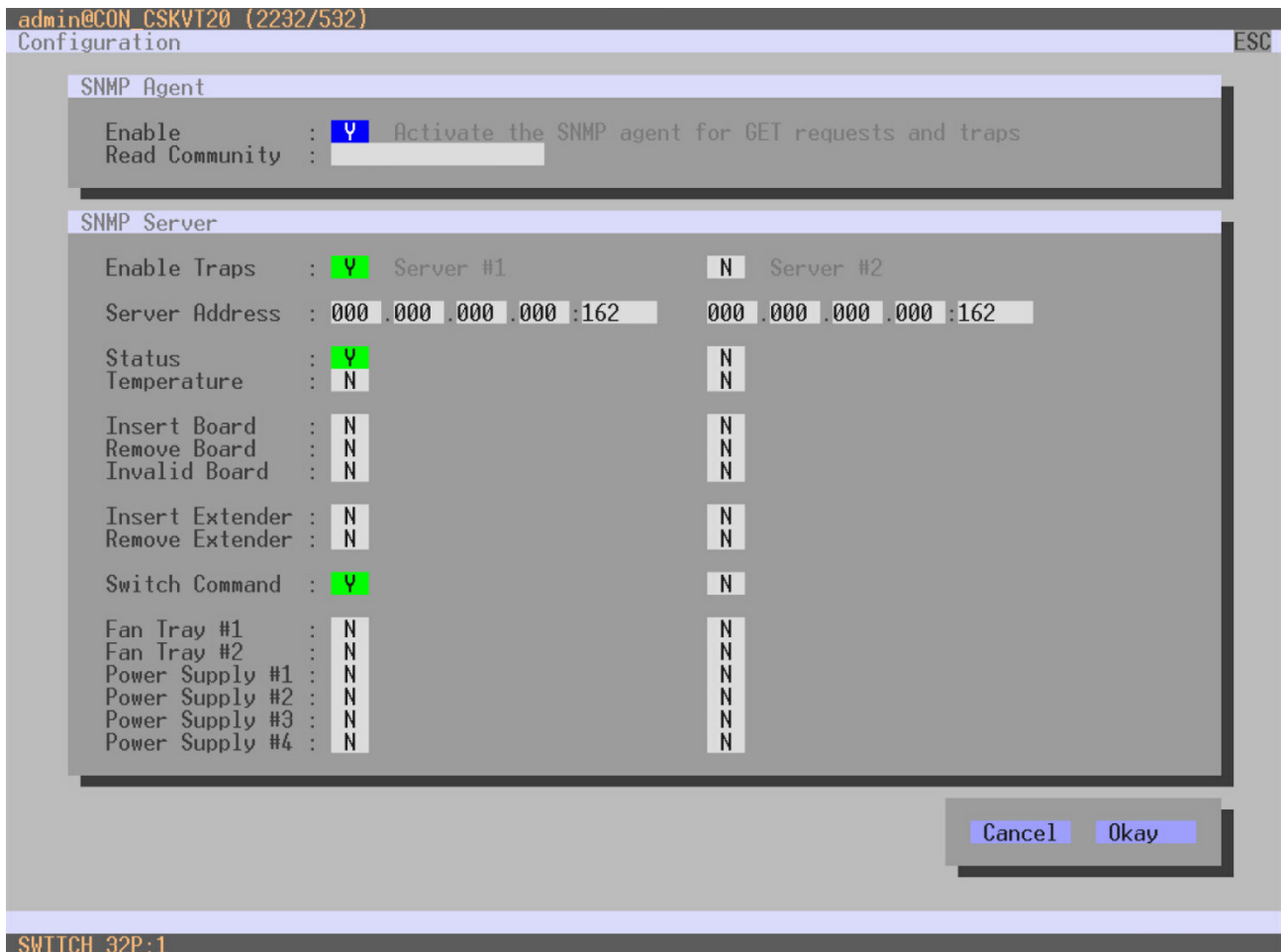

Figure 81. SNMP Monitoring through the OSD

3. Set the **Enable** option to **Y** (Yes) in the **SNMP Agent** pane by pressing the space bar. Activating this option grants permission for an active query of the SNMP agent.
4. Set the **Enable Traps** option to **Y** (Yes) in the **SNMP Server** pane. This allows active transmission of trap messages from the SNMP agent to the SNMP server.
5. Set the IP address of the SNMP server in **Server Address**.
6. Activate the desired traps by setting them to **Y** (Yes).
7. Confirm the selections by clicking the Okay button.

The following traps are available.

Trap	Description
<b>Status</b>	Notification about matrix status
<b>Temperature</b>	Notification about temperature within the matrix
<b>Insert Board</b>	Notification about insertion of a new I/O board into a slot
<b>Remove Board</b>	Notification about removal of an I/O board from a slot
<b>Invalid Board</b>	Notification about a faulty I/O board
<b>Insert Extender</b>	Notification about a connection of a new extender to the matrix, an extender powered on, or a new link between an extender and the matrix
<b>Remove Extender</b>	Notification about removal of an extender from the matrix, an extender powered off, or a link between an extender and the matrix interrupted
<b>Switch Command</b>	Notification about a switching operation performed in the matrix
<b>Fan Tray #1</b>	Notification about the status of fan tray #1
<b>Fan Tray #2</b>	Notification about the status of fan tray #2
<b>Power Supply #1</b>	Notification about the status of power supply unit #1
<b>Power Supply #2</b>	Notification about the status of power supply unit #2
<b>Power Supply #3</b>	Notification about the status of power supply unit #3
<b>Power Supply #4</b>	Notification about the status of power supply unit #4

**Table 30. Available SNMP Traps**

Two SNMP servers can be used at the same time. To view the SNMP status with the OSD, select **Status** in the main menu, and then select **SNMP**.

**Note:** Restart the Orion FX to activate the SNMP agent and changes to SNMP server information.

## SNMP Configuration with the Java Tool

To activate the SNMP-Agent, proceed as follows.

1. Select **System Settings > Network** in the task area.
2. Select the **SNMP** tab.

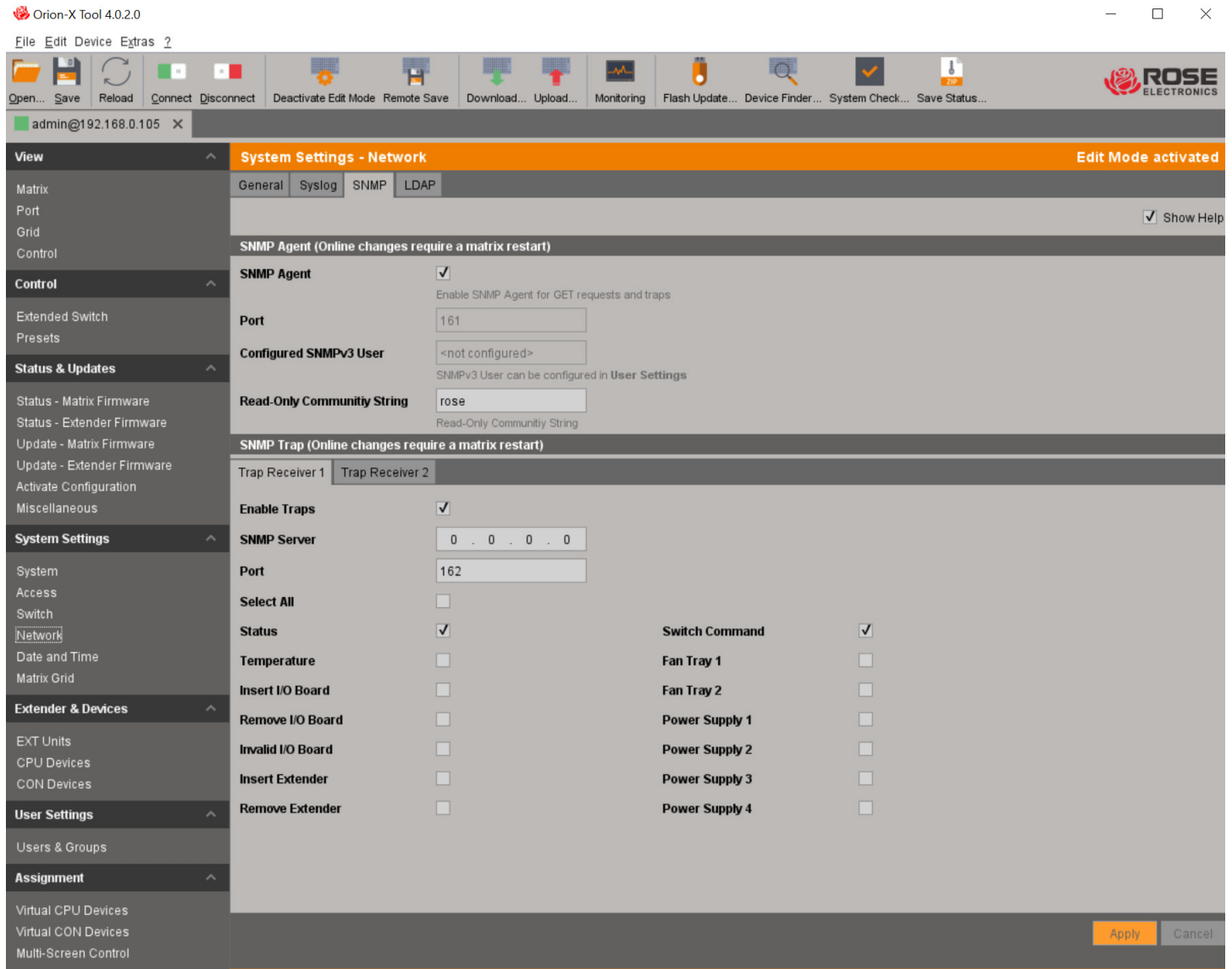

Figure 82. SNMP Monitoring through the Java Tool

3. Tick the **SNMP Agent** check box. Activating this option grants permission for an active query of the SNMP agent.
4. Tick the **Enable Traps** checkbox. This allows active transmission of trap messages from the SNMP agent to the SNMP server.
5. Enter the IP address of the server in the **SNMP Server** field.
6. Activate the desired traps.
7. Click the Apply button.

**Note:** Restart the Orion FX to activate the SNMP agent and any changes to SNMP server information.

## Setting up SNMP Options with the Java Tool

Presets for an SNMPv3 user can be set up for the computer on which the Java Tool software is located.

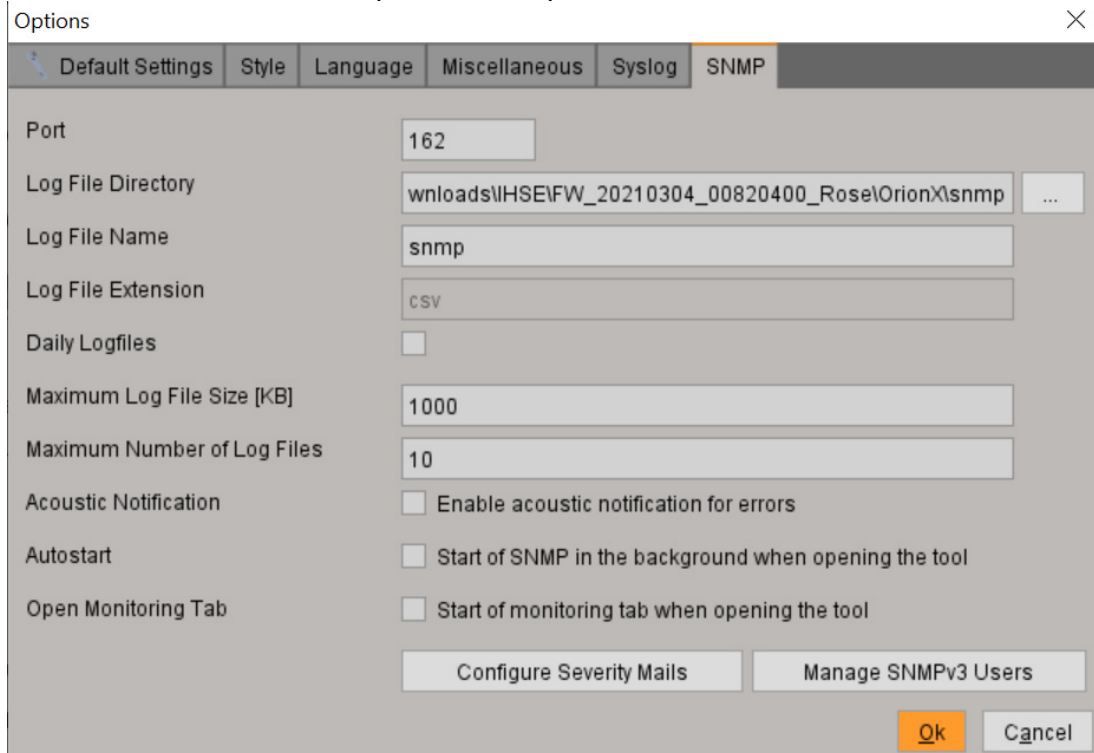

Figure 83. Setting SNMP Options in the Java Tool

To set or activate presets, proceed as follows:

1. Select **Extras > Options** in the menu bar and open the **SNMP** tab.
2. Click the **Manage SNMPv3 Users** button. A list of previously created SNMPv3 users is displayed
3. Click the **Add User** button. A dialog window is displayed.

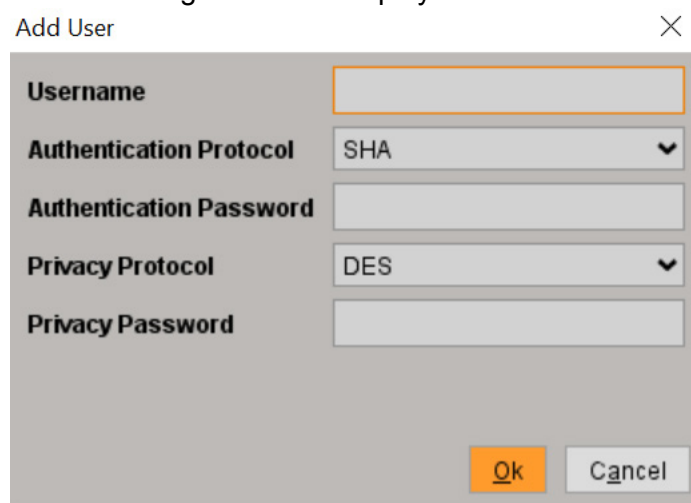

Figure 84. Add SNMP User in the Java Tool

4. Enter the required data and click the **Ok** button to confirm the entries.
5. Click the **Close** button to close the users list.
6. Click the **Ok** button in the **SNMP** tab to confirm the settings.
7. Close the Java Tool software and restart it

## Date and Time

This menu allows changes to the Date and Time, based on Simple Network Time Protocol (SNTP). This menu can be accessed in the OSD and the Java Tool.

The following settings can be modified.

Field	Selection	Description
<b>SNTP Client</b>	Y	Enable network time server synchronization
	N	Function not active (default)
<b>SNTP Server</b>	Byte	Enter the SNTP server's IP address (default: 000.000.000.000)
<b>Time Zone</b>	Region	If SNTP is active, enter the time zone where the matrix is installed.
<b>Month</b>	1-12	Enter month
<b>Date</b>	1-31	Enter date
<b>Year</b>	1-99	Enter year
<b>Day of the week</b>	1-7	Enter day of the week
<b>Hours</b>	0-23	Enter hour
<b>Minutes</b>	0-59	Enter minute
<b>Seconds</b>	0-59	Enter second

**Table 31. Date and Time Settings**

**Note:** Date format is according to English notation.

## Modifying Date and Time Settings through the OSD

→ Select **Configuration** in the main menu, log in, and select **Date+Time**.

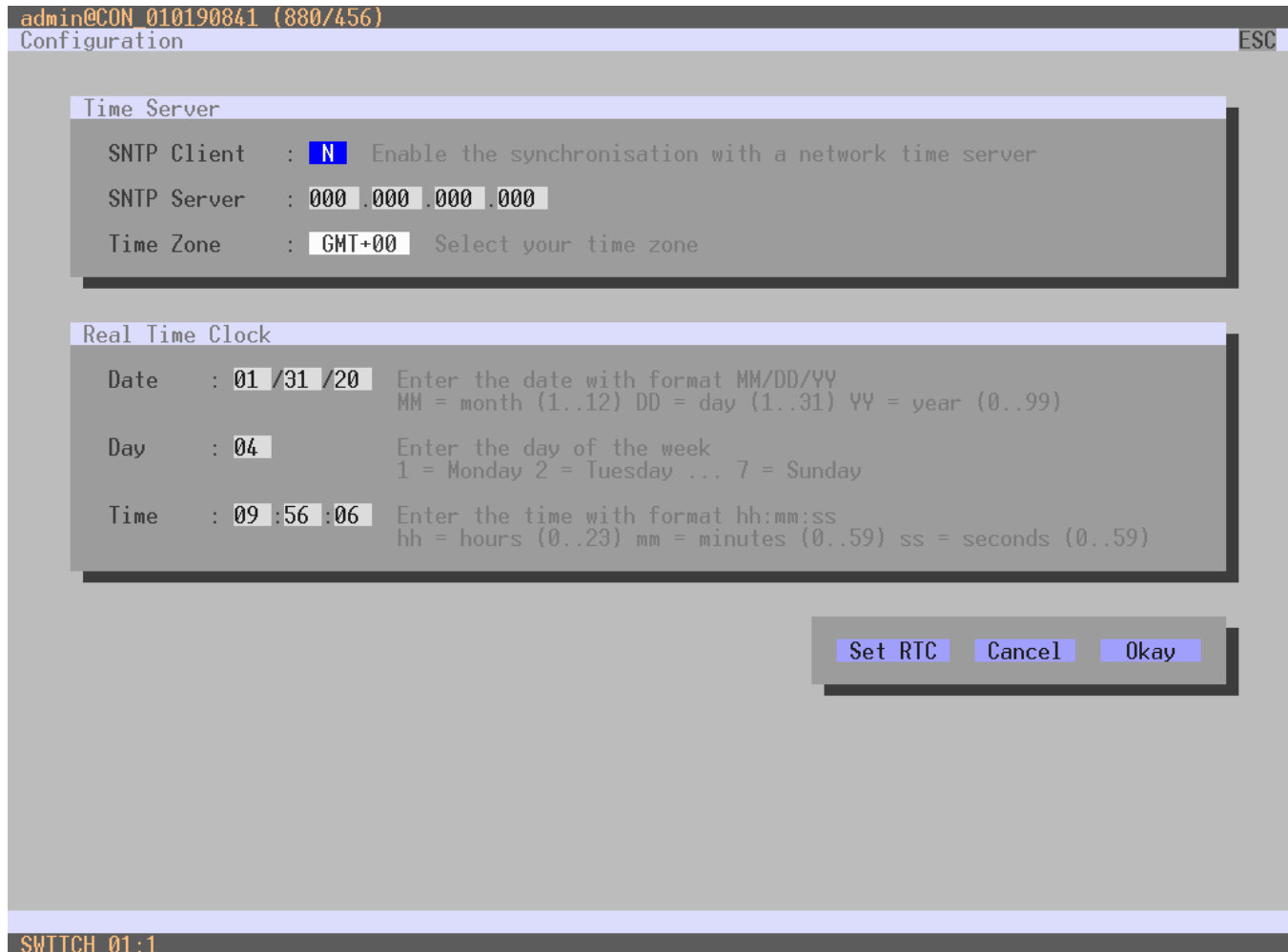

Figure 85. Modifying Date and Time Settings through the OSD

To configure Orion FX to use a timeserver, proceed as follows:

1. Set the **SNTP Client** option to **Y** (Yes).
2. Enter the IP address of the SNTP server in the **SNTP Server** field.
3. Select the time zone for the region where the Orion FX is located in the **Time Zone** field.
4. Click the **Okay** button to confirm the settings.
5. Restart the matrix. The system time will now be synchronized with the SNTP server.

To set the real time clock without using SNTP, proceed as follows:

1. Set the current date in the **Date** field.
2. Set the current day of the week in the **Day** field (Monday = 1).
3. Enter the current time (international standard notation) in the **Time** field.
4. Click the **Set RTC** button to confirm the settings.

## Modifying Date and Time Settings through the Java Tool

→ Select **System Settings > Date and Time** in the task area.

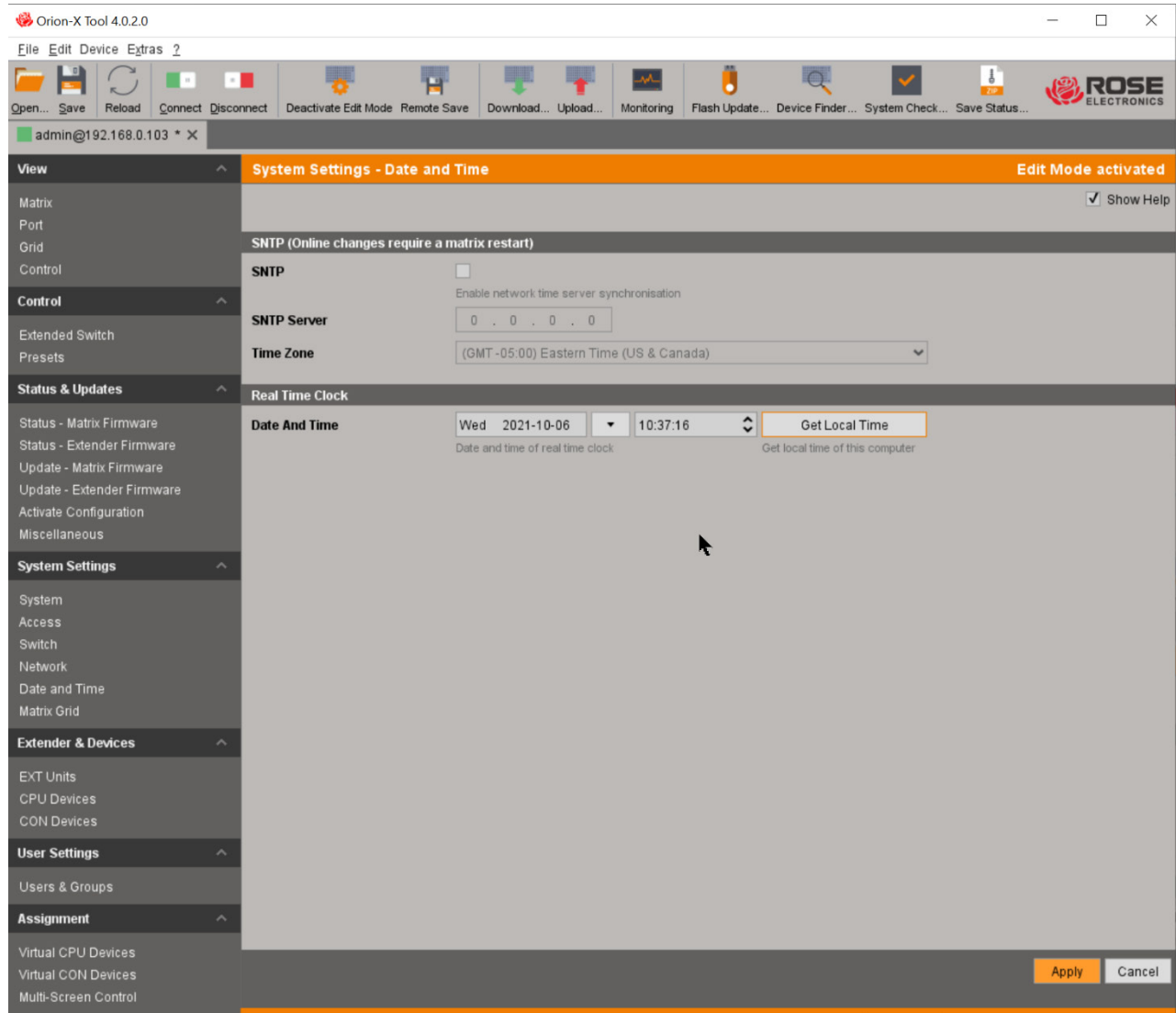

Figure 86. Modifying Date and Time Settings through the Java Tool

To configure Orion FX to use a timeserver, proceed as follows:

1. Enable **SNTP** option.
2. Enter the IP address of the SNTP server in the **SNTP Server** field.
3. In the **Time Zone** field, select the time zone for the region where the Orion FX is located.
4. Click the **Apply** button to confirm the settings.
5. Restart the matrix. The system time will be now synchronized with the SNTP server.

To set the real time clock without using SNTP, proceed as follows:

1. Set the current date in the **Date** field.
2. Set the current time in the **Time** field.
3. Click the **Apply** button to set the system time.
4. Option: To set the Orion FX time using the current time of the computer running the Java Tool, click the **Get Local Time** button.

## Configuring User Settings

Users and their permissions can be created and modified through the OSD and the Java Tool.

### User

Select from the following settings to create a new user or to edit an existing user's attributes.

Field	Selection	Description
<b>ID/Priority</b>	Integer	User ID/User priority (0 – 999)
<b>Name</b>	Text	Standard users: the login name (case sensitive, 1 to 16 characters)
		LDAP Users: the name (case sensitive, 1 to 16 characters)
		Users synchronized via LDAP: the sAMAccountName, retrieved from the LDAP server.
<b>Full Name</b>	Text	Standard users: the full descriptive name (1 to 32 characters)
		LDAP Users: the login name (1 to 32 characters)
		Users synchronized via LDAP: the userPrincipalName retrieved from the LDAP server
<b>Password</b>	Text	Standard users: user password (case sensitive, 1 to 16 characters)
		LDAP Users: the password retrieved from the server (case sensitive, 1 to 16 characters)
<b>Member of Group</b>	Selection	User Group assignment
<b>Administrator</b>	Y	Permission for system configuration and all switching operations
	N	Administrator permissions not granted (default)
<b>Super User</b>	Y	Permission to switch any console to any CPU in <b>Extended Switching</b> .
	N	Super User permission not granted (default)
<b>Power User</b>	Y	Permission to switch consoles to CPUs in <b>Extended Switching</b> according to the CON ACL or User ACL (see <b>Access Control</b> ), but not in Private Mode
	N	Power User permission not granted (default)
<b>SNMP User</b>	Y	Permission to use SNMPv3 (encrypted)
	N	SNMP permission not granted (default)
<b>Auto Connect</b>	Y	After user login, re-establish the last CPU connection
	N	Function not active (default)
<b>AD Synchronized</b>	Y	Synchronize group attribute for users from an Active Directory
	N	Function not active (default)
<b>AD Group Locked</b>	Y	Lock synchronization of group attribute for users from an Active Directory. This is required for a manual change of user groups for a specific Active Directory user.
	N	Function not active (default)

**Table 32. User Settings**

## Modifying User Settings through the OSD

→ Select **User Data** in the Configuration menu.

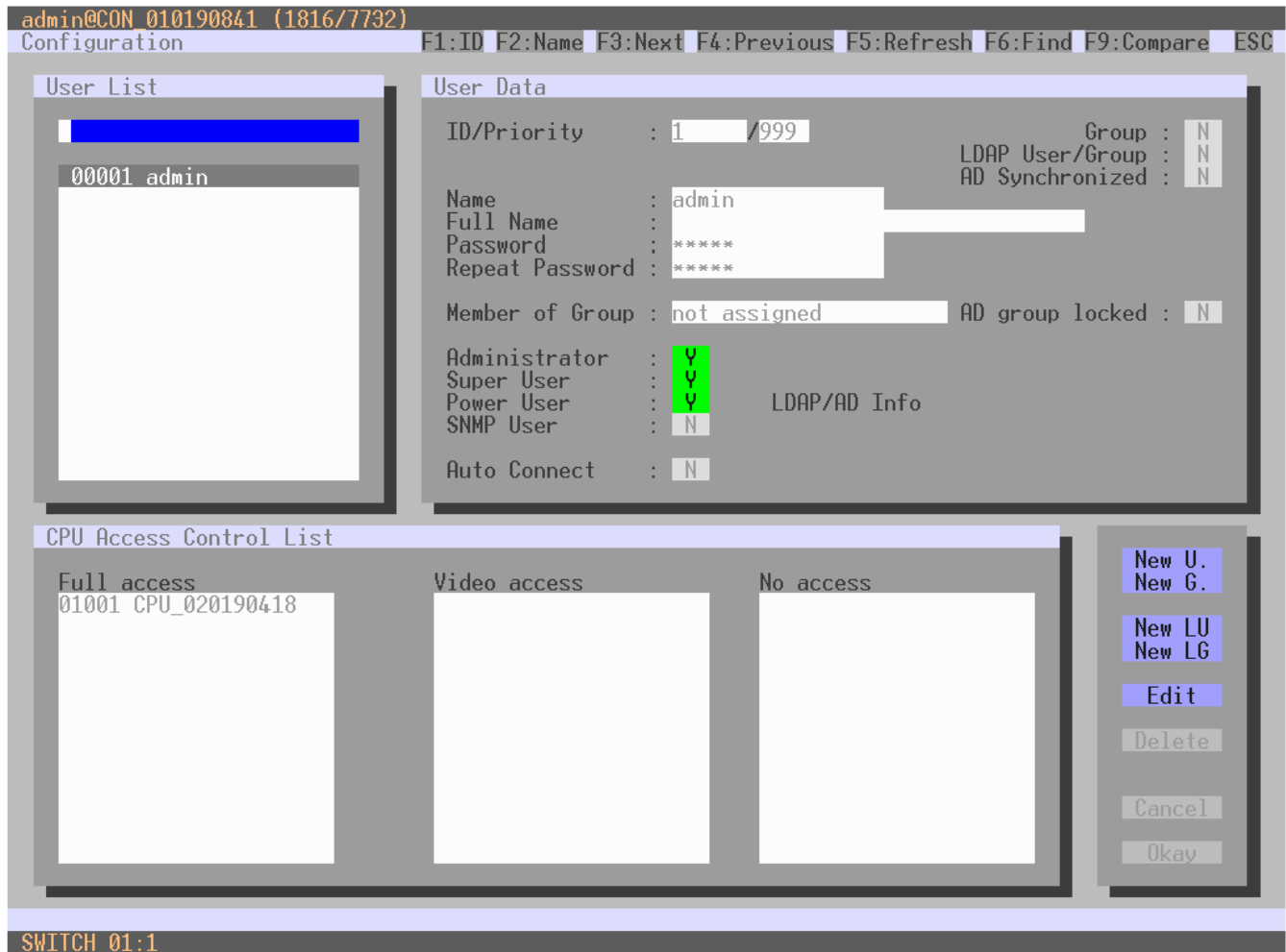

Figure 87. Modifying User Settings through the OSD

The User List contains the ID number and name of all users and user groups.

These buttons can be used to create and edit users and groups:

Button	Function
<b>New U.</b>	Create a new user
<b>New G.</b>	Create a new user group
<b>New LU</b>	New LDAP user
<b>New LG</b>	New LDAP user group
<b>Edit</b>	Edit the currently selected user or group
<b>Delete</b>	Delete the selected user or group
<b>Cancel</b>	Reject changes
<b>Okay</b>	Save Changes

Table 33. Buttons in the OSD User Settings Screen

To create a new user with the OSD menu, proceed as follows:

1. Click the **New U.** button. The Priority field will be selected.
2. Assign a relative priority to the new user (0 to 999), and press Tab. A higher number indicates a higher priority.
3. A system generated user name will be displayed. Edit the user name as desired, using up to 16 characters, and press Tab.
4. The **Full Name** field can be used to input the user's full name or description. Press Tab.
5. Enter a login **Password** for the user. Press Tab.
6. Confirm the password by entering it again in the **Repeat Password** field and press Tab.
7. By default, new users are not assigned group membership. To make the new user a member of an existing group, press the down arrow key until the desired group appears in the **Member of Group** field. Press Tab.
8. By default, new users are not assigned advanced user privileges. To make the new user an **Administrator, Super User, Power User** or **SNMP User**, tab to the appropriate field and press the space bar to change the default 'N' selection to 'Y'.
9. Press the Tab key to reach the **Auto Connect** field. To cause the system to automatically reconnect the new user to their last connected CPU device each time they log in, press the space bar to change the default 'N' selection to 'Y'. Press Tab to move to the **CPU Access Control List**.
10. Initially there will no CPU devices in the new user's **Full access** or **Video access** list. Press Tab twice to move to the **No access** list of computers.
11. To move a CPU device from the new user's No access list to the Full access list, select it and type the "f" key.
12. To move a CPU device from the new user's **No access** list to the **Video access** list, select it and type the "v" key.
13. After modifications to the new user's Access Control list are complete, press Tab to highlight the **Cancel** button. To discard all information and selections for the new user, press Enter.
14. To retain the new user's information, press Tab to highlight **Okay** and press Enter.

## Modifying User Settings through the Java Tool

- ➔ Select **User Settings > Users & Groups** in the task area.
- ➔ Select the **User** tab in the working area to create users or edit existing user information.

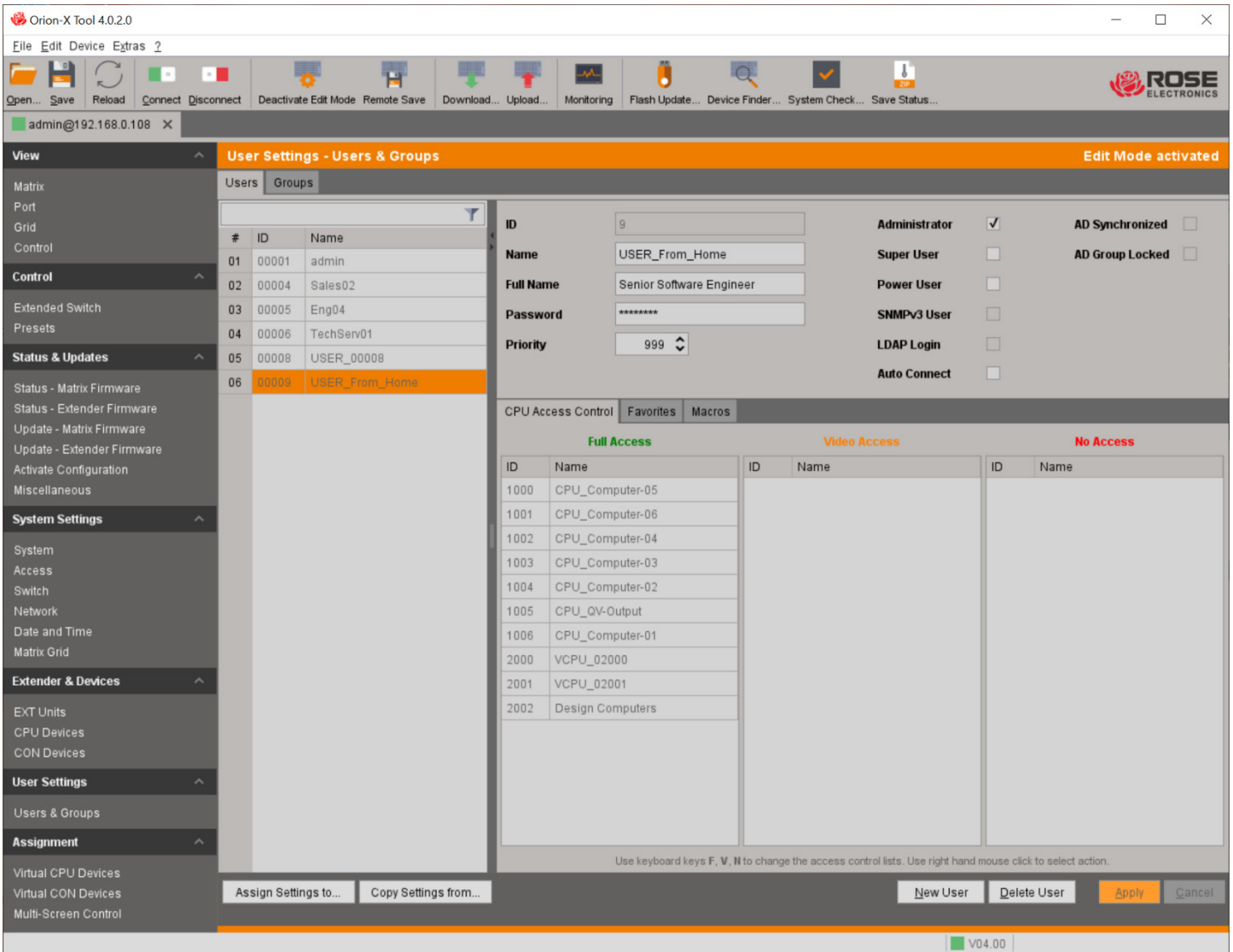

Figure 88. Modifying User Settings through the Java Tool

Select between the following buttons:

Button	Function
<b>New User</b>	Open a new user configuration
<b>Delete User</b>	Delete an existing user
<b>Apply</b>	Create a new user account
<b>Cancel</b>	Reject changes

Table 34. Buttons in the Java Tool User Settings Screen

To create a new user, proceed as follows:

1. Click the **New User** button.
2. Choose from standard User, LDAP User, SNMP User, or choose to use an existing user as a template.

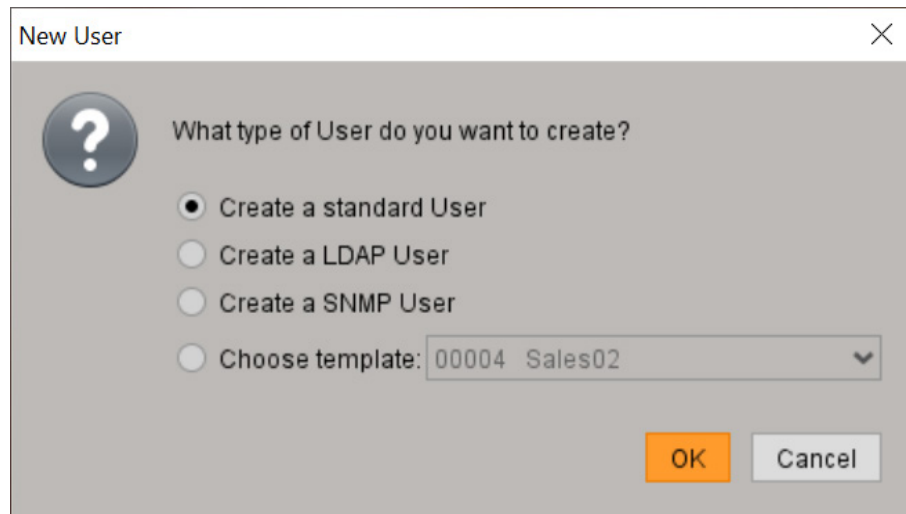

Figure 89. Choosing a User Type in the Java Tool

3. Click the **OK** button.
4. A system generated user name will be displayed. Edit the user name as desired.
5. Optionally, enter a more descriptive **Full Name** for the user.
6. Enter a **Password**, confirm the entry and click Ok.

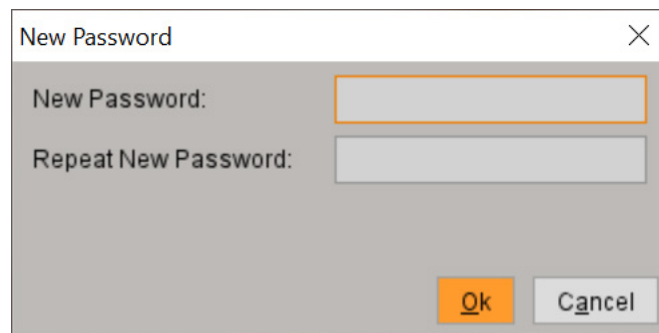
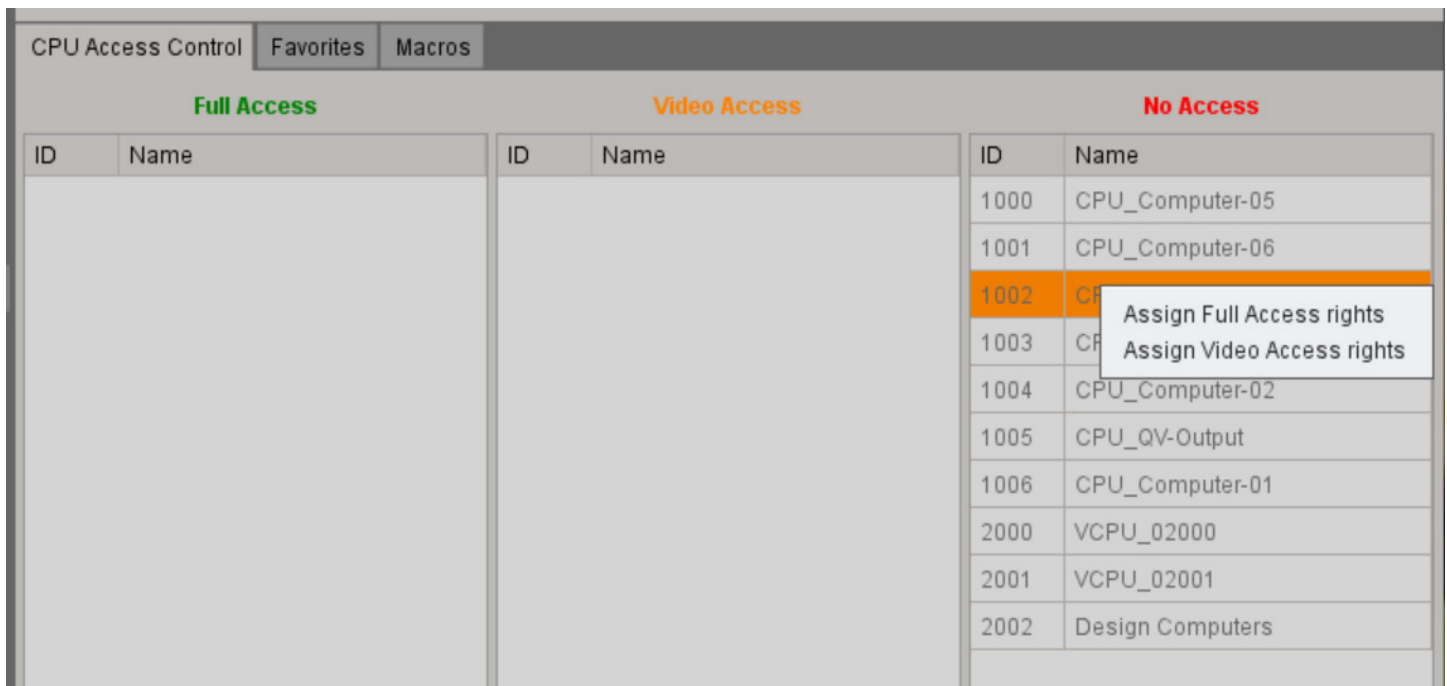

Figure 90. New User Password Assignment in the Java Tool

7. Select the desired **Priority**, from 0 to 999.
8. If the user needs the additional access rights of an Administrator, Super User, or Power User, click on the appropriate box.

- To give the new user CPU access rights, right click on CPUs in the **No Access** list and then click on **Assign Full Access rights** or **Assign Video Access rights** in the pop-up menu. The selection will be added to the appropriate column.



**Figure 91. Assigning New User Access Rights in the Java Tool**

- Alternatively click on a CPU device name to select it and type <f> to move it into the Full Access list, <v> to move it to the Video Access list, or <n> to move it to the No Access list
- Click the **Favorites** tab, and select a CPU device from the **CPU Device available** list to add to the user's favorites for easy OSD access.
- Optionally hold down the keyboard Ctrl button and click on other CPU devices to add them to the selection.
- Click the single right arrow button to add the selected CPU devices to the **Favorite CPU Devices** list.
- To add all the CPU devices, click the double right arrow button.
- Click on entries in the **Favorite CPU Devices** list and press the keyboard <+> or <-> keys to move the selection higher or lower in the list.
- Click the **Apply** button to save the new user settings.

## User Favorites List

This menu is used to create individual favorites lists of CPU devices that users switch to frequently. A favorites list can contain the names of up to 16 different CPU devices. Switching to favorites can be done from the keyboard using a 'Hot Key' sequence. This menu can be accessed in the OSD and the Java Tool.

### Setting up User Favorites through the OSD

The OSD User Favorites menu is not a part of the Configuration menu's User Data section, but is found in the Main menu's Assignments submenu. Login is required to access the User Favorites menu, and the Favorites list created there will apply to the logged in user.

→ Select **Main Menu > Assignments**.



Figure 92. OSD Main Menu

→ Select **User Favorites** and log in

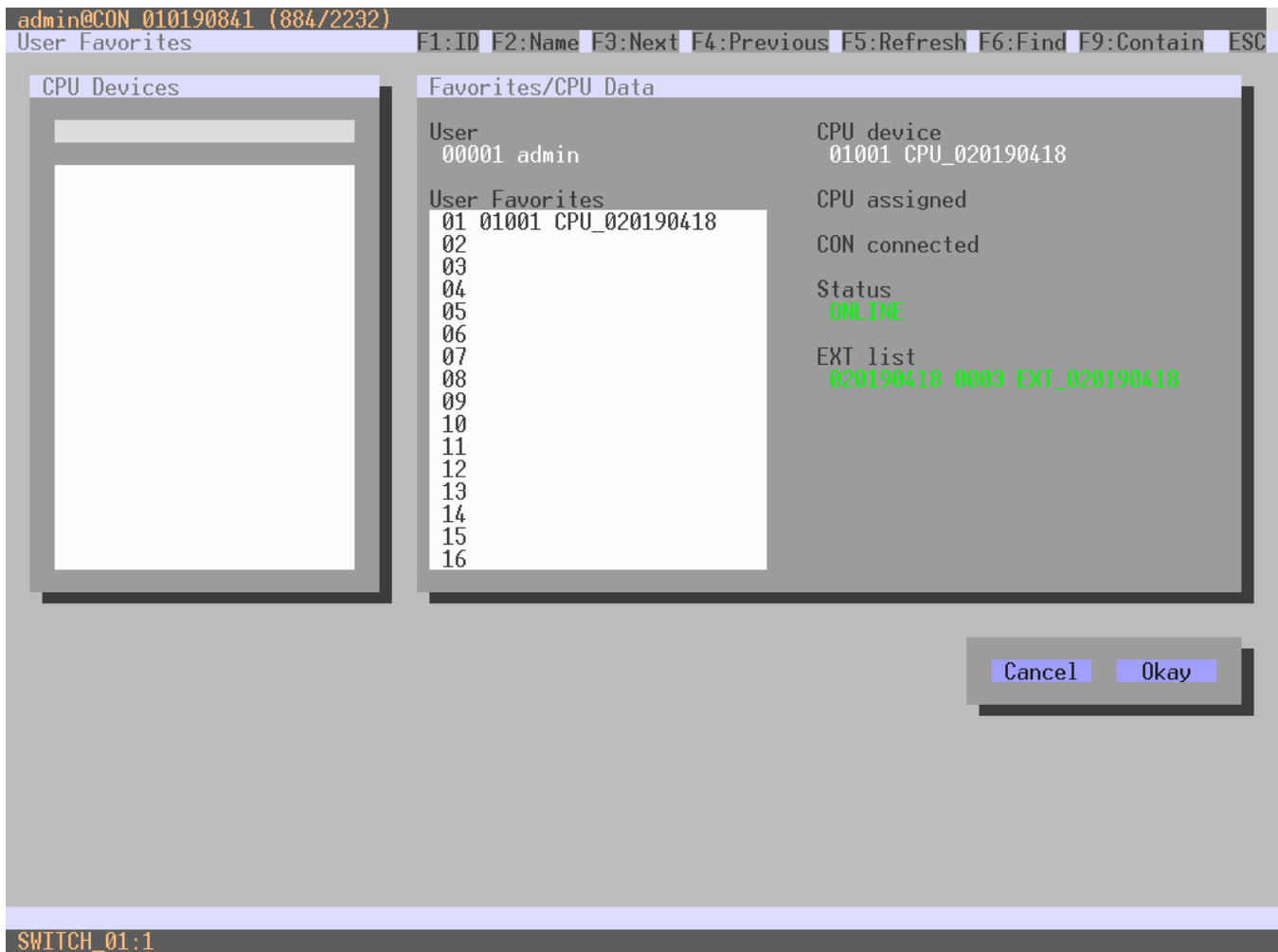

Figure 93. User Favorites OSD menu

To create a favorites list for the logged in user, proceed as follows:

1. Select a CPU from the **CPU Devices** list to add to the favorites list. Press <a> to add the CPU Device to the favorites list. Remove a CPU from a favorites list by selecting it and pressing <r>.
2. The order of the CPU devices within the favorites list can be changed by selecting a CPU device and pressing <+> and <->.
3. Click the **Okay** button to save the settings.

## Setting up User Favorites through the Java Tool

- Select **User Settings > Users & Groups** in the task area.
- Select the **User** tab in the work area and select a user whose favorites list should be modified.
- Select the Favorites tab.

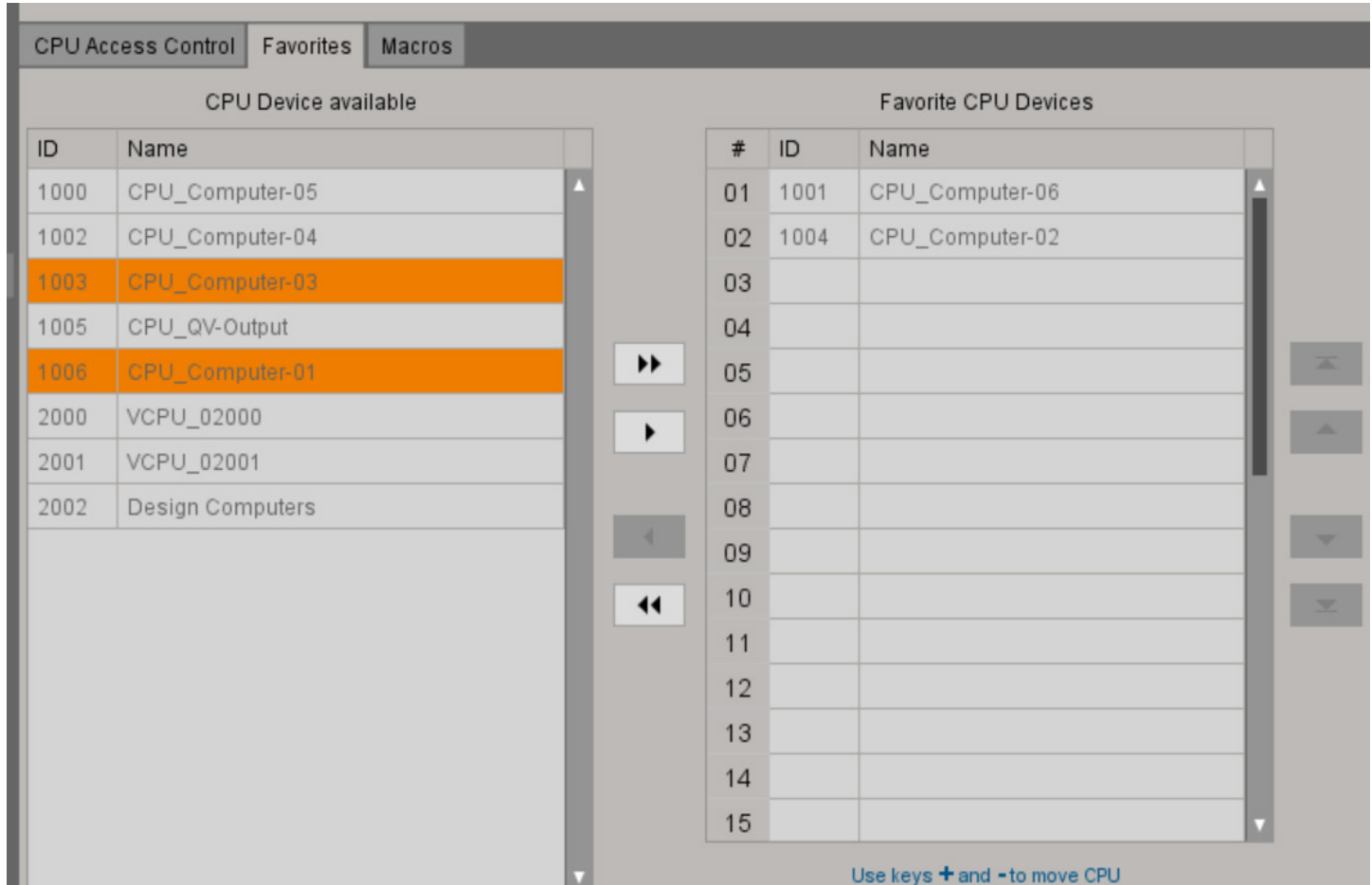

Figure 94. Setting up a User Favorites List with the Java Tool

To create a favorites list for the selected user, proceed as follows:

1. Select CPU devices in the **CPU Device available** list to be added to the user's **Favorite CPU Devices** list. Press and hold the <Ctrl> key to select more than one CPU device at a time.
2. Click the > button to move the selected CPU devices to the favorites list. If the >> button is clicked, the first 16 CPU devices in the **CPU Device available** list will be moved to the favorites list.
3. A selected CPU device within the **Favorite CPU Devices** list can be moved up or down in the list by selecting it and pressing the <+> and <-> keys.
4. To remove a CPU from the favorites list, select it and press the < button. If the << button is pressed, all CPU devices will be removed from the favorites list.

## User Macros

This menu is used to create macro commands for switching, disconnection or user administration. It can be found in the OSD and the Java Tool.

Macro commands are created for each user individually. A macro can execute up to 16 switching commands successively. Macros 1 through 16 are invoked by pressing the 'Hot Key' and the function keys <F1> to <F16>. Macros 17 through 32 are invoked by pressing the 'Hot Key' and <Shift> + <F1> to <F16>.

**Note:** The user must be logged in to the Orion FX to invoke user macros.

The following actions can be assigned to a User Macro:

Field	Selection	Description
Function (01-16)	<b>Connect (P1=CON, P2=CPU)</b>	Make a bidirectional connection from console P1 to CPU P2
	<b>Connect Video (P1=CON, P2= CPU)</b>	Make a video connection from console P1 to CPU P2
	<b>Disconnect (P1=CON)</b>	Disconnect console P1
	<b>Logout User</b>	Logout current user
	<b>Assign CPU (P1=VCPU, P2=RCPU)</b>	Assign a virtual CPU device to a real CPU device (see <i>Virtual CPU</i> )
	<b>Assign CON (P1=RCON, P2=VCON)</b>	Assign a real console device to a virtual console device (see <i>Virtual Console</i> )
	<b>Push (P1=CON)</b>	The user's current KVM connection is forwarded to console P1 and the user's connection is changed to a video only connection.
	<b>Push Video (P1=CON)</b>	The video signal of the user's current connection (either KVM or video only) is forwarded to console P1. The user's connection remains unchanged (KVM or video only).
	<b>Get (P1=CON)</b>	The user's console gets a KVM connection to the CPU that is currently connected to console P1. The connection of console P1 is changed into a video only connection.
	<b>Get Video (P1=CON)</b>	The user's console gets a video only connection to the CPU that is currently connected to console P1. The connection of console P1 remains unchanged (KVM or video only).
	<b>Login User (P1=CON, P2=User)</b>	Login User P2 at console P1
<b>P1</b>	Con or CPU device	Name of CON or CPU device
<b>P2</b>	Con or CPU device, or User	Name of CON or CPU device, or User ID

**Table 35. User Macro Settings**

**Note:** Macros can also be used to switch to CPU groups.

## Setting up User Macros through the OSD

→ Select **Configuration** in the main menu, log in, and select **User Macros**.

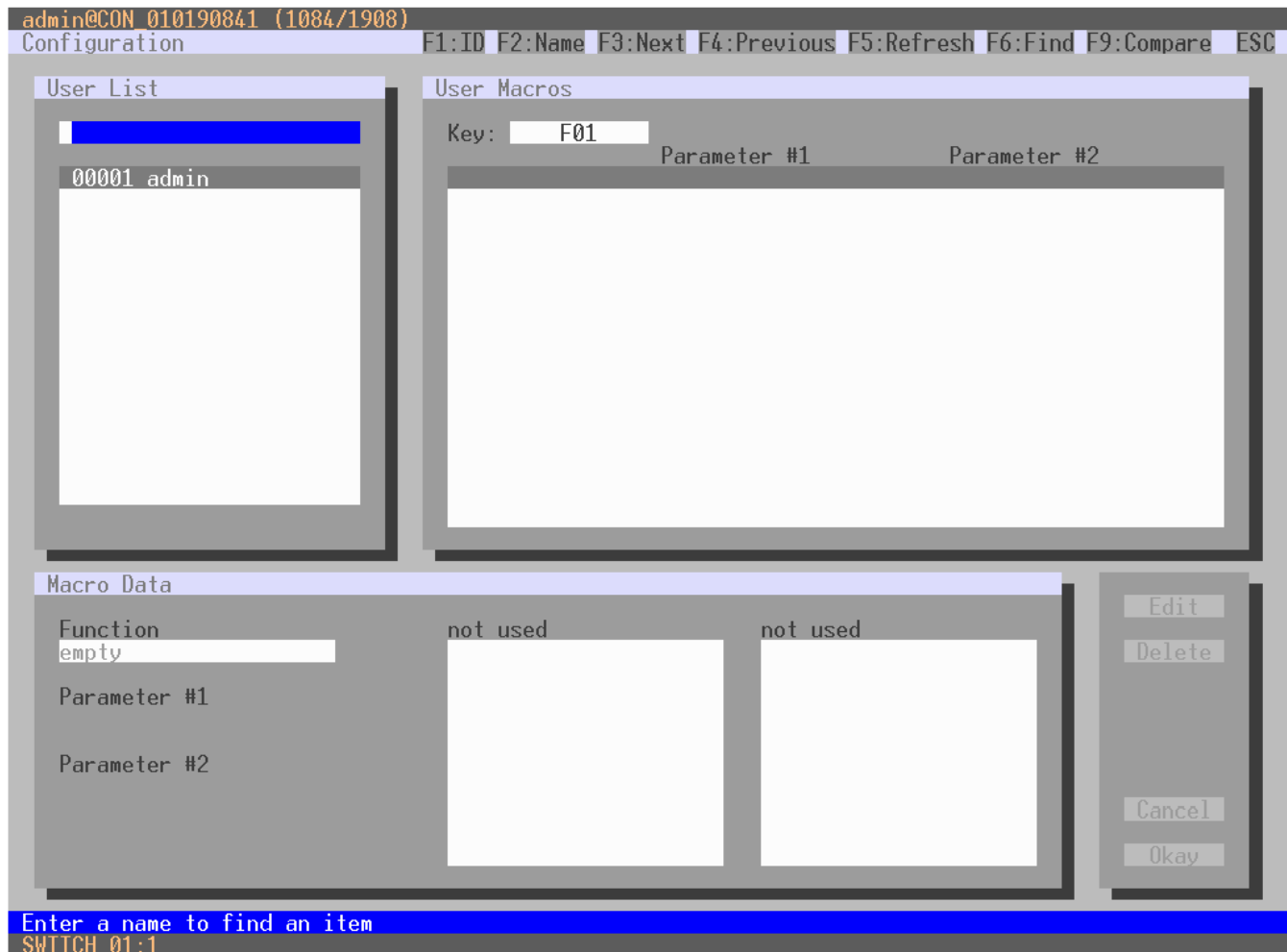

Figure 95. Setting Up User Macros through the OSD

To create a macro for a user, proceed as follows:

1. Enter characters in the Find Field to locate a user in the list, and then press tab to select the user.
2. Alternatively press the Tab key in the Find Field to move to the User list and use the up or down arrow keys to select a user.
3. Press the Tab key to move the selection to the **Key** field and use the up or down arrow keys to select the function key (F1 to F16) to which a macro is to be assigned.
4. Press the Tab key to move the selection to the list of existing macros. Use the up or down arrow keys to select the position in the macro list where the new macro command is to be inserted.
5. Press the Tab key to move the selection to the **Edit** button.
6. Press Enter to select the Function field. Use the keyboard up or down arrow keys to change functions.
7. Press the Tab key to move to the Parameters #1 field. Use the keyboard up or down arrow key to select the desired value for Parameter #1.
8. Press the Tab key to move to the Parameters #2 field. Use the keyboard up or down arrow key to select the desired value for Parameter #2.
9. Press the Tab key to highlight the Cancel and Okay buttons. Select the Okay button and press the enter key to confirm the user's new macro.

## Setting up User Macros through the Java Tool

➔ Select **User Settings > Users & Groups** In the working area, select the user for whom macros are to be created and click the **Macros** tab.

The screenshot shows the Orion-X Tool 4.0.2.0 interface. The main window is titled "User Settings - Users & Groups" and "Edit Mode activated". The "Users" tab is selected, showing a list of users:

#	ID	Name
01	00001	admin
02	00004	Sales02
03	00005	Eng04
04	00006	TechServ01
05	00008	USER_00008
06	00009	USER_From_Home

The "Sales02" user is selected. The "Macros" tab is also visible, showing a table for defining key macros:

#	Function	P1	P2
01	Connect Video (P1=CON, P2=CPU)	Current CON Device	01001 CPU_Computer-06
02			
03			
04			
05			
06			
07			
08			
09			
10			
11			
12			
13			

Figure 96. Setting Up User Macros through the Java Tool

To create a macro for the selected user, proceed as follows:

1. Select the Function key (F1 to F16, or Shift + F1 to F16) in the **Key** field to assign to the macro. Currently assigned function keys will appear green in the horizontal display of function key icons.

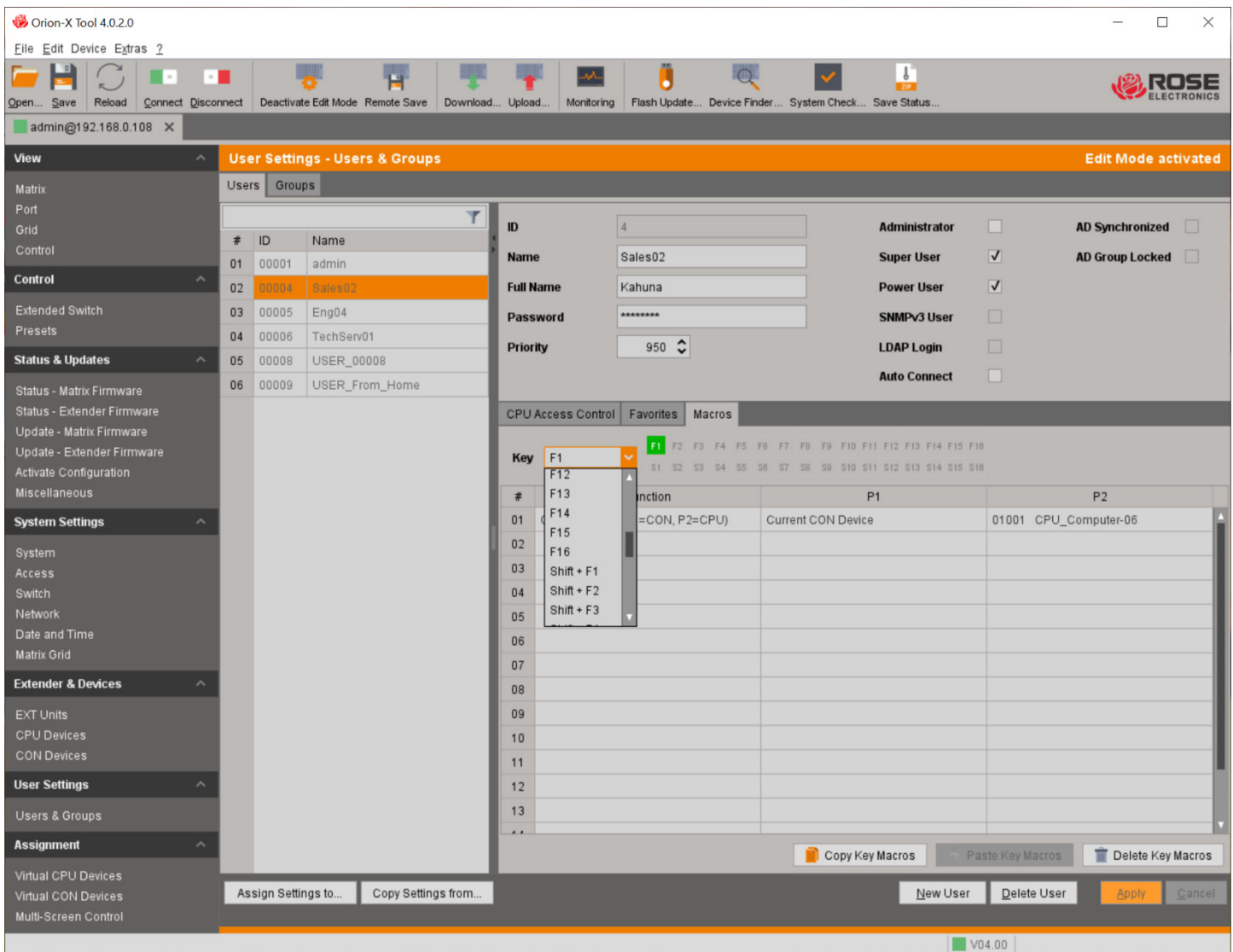

Figure 97. User Macros Function Key selection with Java Tool

- Select the commands that should be part of the macro in the **Function** column. Double click an empty field in the function column and select a function for the macro from the list.

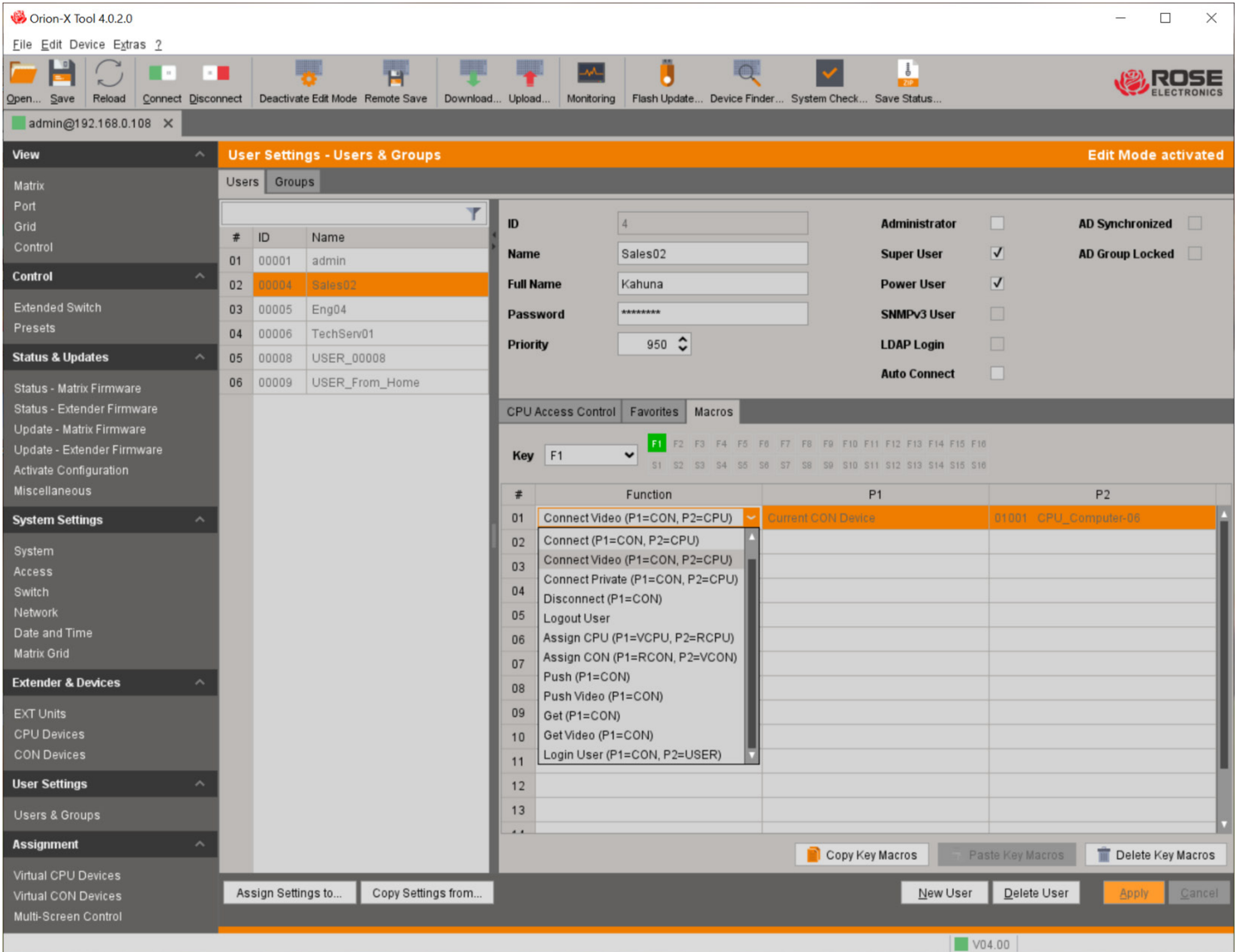

Figure 98. User Macro Function Selection with Java Tool

- If the function requires parameters, select the values for parameters **P1** and **P2**, as required (e.g. corresponding consoles and CPUs).

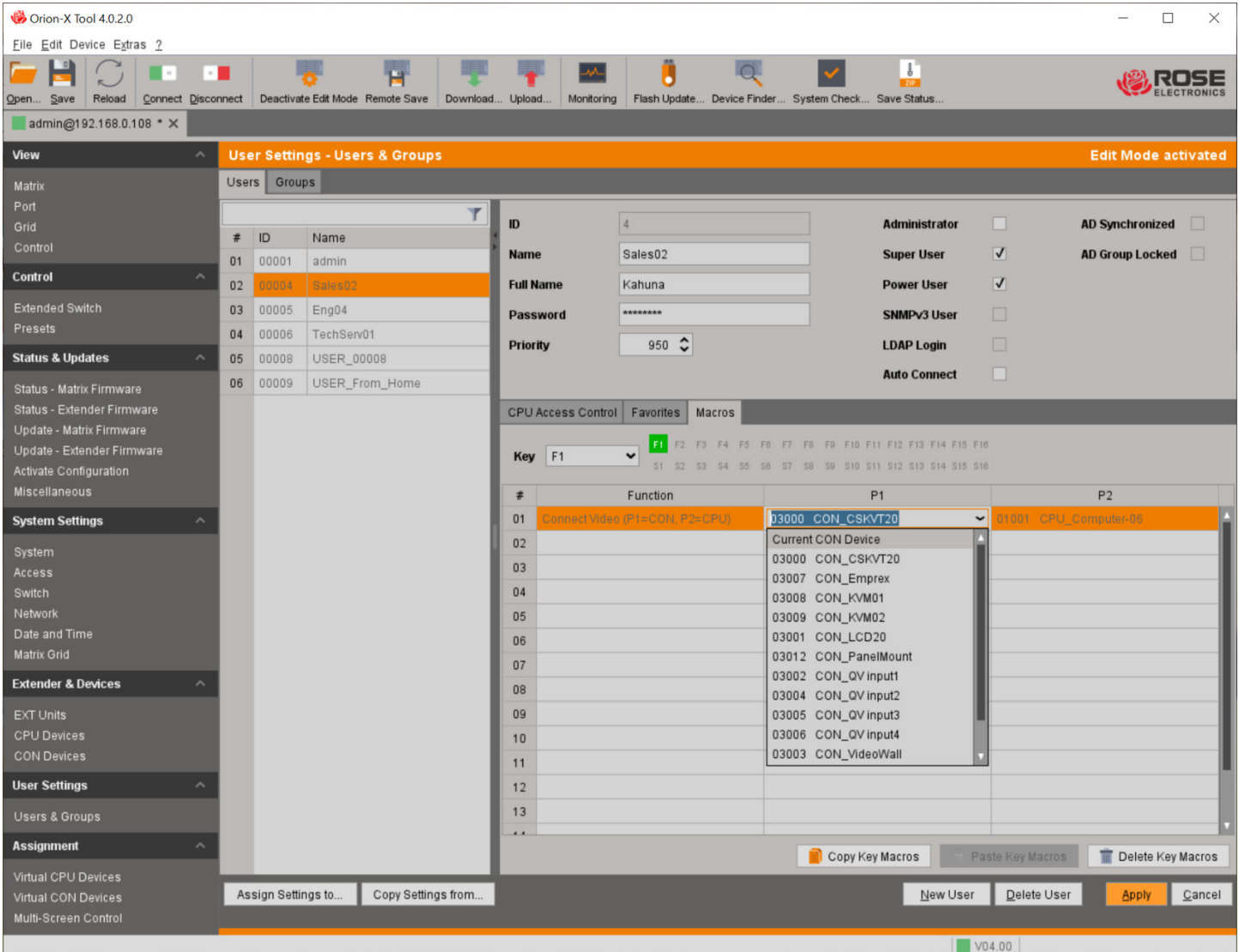

Figure 99. User Macro Parameter Selection with Java Tool

- Confirm the macro by clicking the **Apply** button.

For convenient macro configuration, the following context functions are available:

- ➔ To assign a given user's macros to other users, click on the user's name, then click the **Assign Settings to...** button below the User list. Select **Macros** from the list of settings displayed, and then click **Next**. Select the user or users to receive the macros from the list of available user names and click the > button to add those names to the **Assign settings to...** list. Click **Finish** to complete the macros assignment. The **Copy Settings from...** button functions similarly, except the user to receive macros is selected first.
- ➔ All the macro commands of a selected key can be copied into the cache by clicking the **Copy Key Macros** button. These macros can then be pasted into a different key by selecting the key and clicking the **Paste Key Macros** button. All macros of a selected key can be removed by using the **Delete Key Macros** function.

## User Groups

The Orion FX provides for the creation of User Groups, aggregates of similar types of users who have similar computer access needs, for instance all power users, or all Software Engineers. The members of a group are given the same kind of access to the same computers, in addition to any individual access rights they may have. This can greatly simplify access administration in larger systems. The menus for creating User Groups can be accessed with the OSD and with the Java tool.

### Setting up User Groups through the OSD

→ Select **Configuration** in the main menu, log in, and select **User Data**.

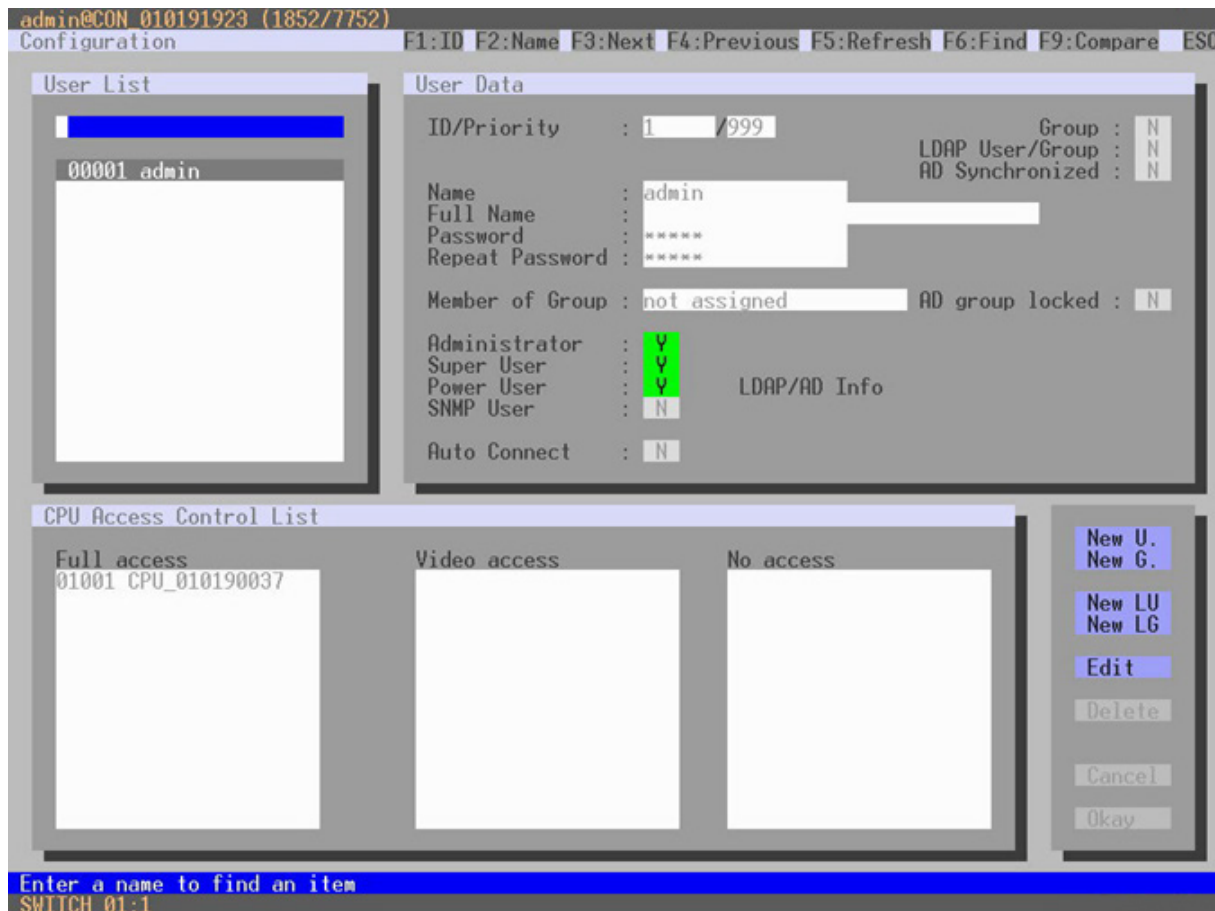

Figure 100. User Groups Settings in the OSD

### Creating a Standard User Group

1. Click the **New G...** button.
2. Enter a group name into the field **Name**.
3. Click the **Okay** button to save the Group.

### Creating an LDAP Group

1. Click the **New LG** button to create a new LDAP group. The group determines which users in the Active Directory server should be synchronized.
2. Enter a name into the field **Name**.
3. Enter either the Common Name (CN) of a group or the name of an organizational unit (OU) into the field **LDAP OU=/CN=** , where:
  - OU = the name of the organizational unit
  - CN = the name of the group**Note:** the field entry must include either OU= or CN=.
4. Click the **Okay** button to confirm the creation of the group. Active Directory synchronization can now be used.

**Note:** an Orion FX configuration should include only one LDAP user and one LDAP group at the same time. The LDAP user and the LDAP group can be created, changed or deleted during ongoing operation, and does not require a restart of the system.

### Assigning a User to a Group

To assign a user to a group, proceed as follows:

1. Select the user you want to assign to a User Group.
2. Select the User Group for the assignment in the field **Member of Group** using the cursor up and down keys.
3. Click the **Okay** button to confirm the assignment.

## Setting up User Groups through the Java Tool

1. Select **User Settings > Users & Groups**, and select the **Groups** tab in the working area.

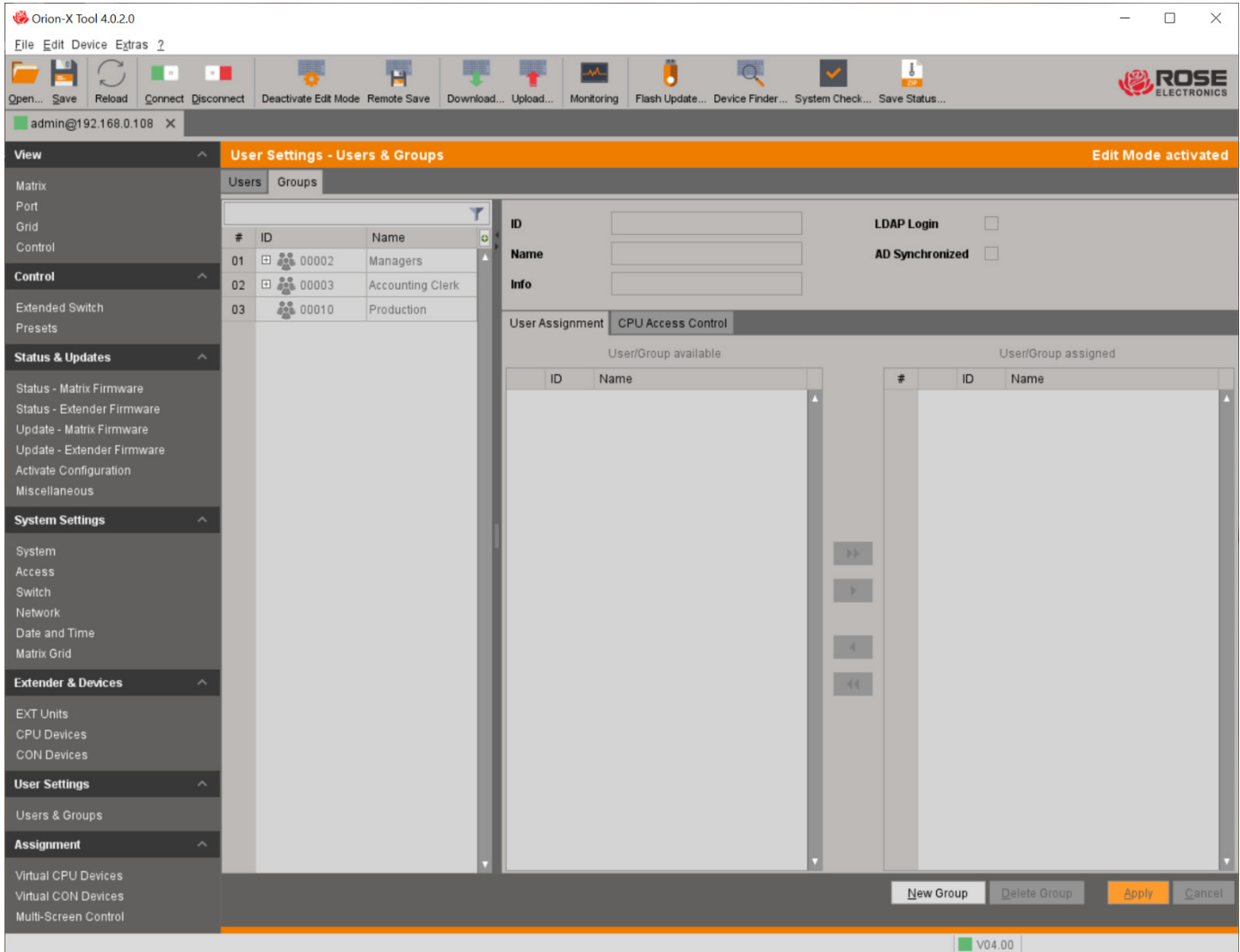

Figure 101. Setting up User Groups with the Java Tool

2. Click the **New Group** button
3. Select the New Group's type and click **OK**.

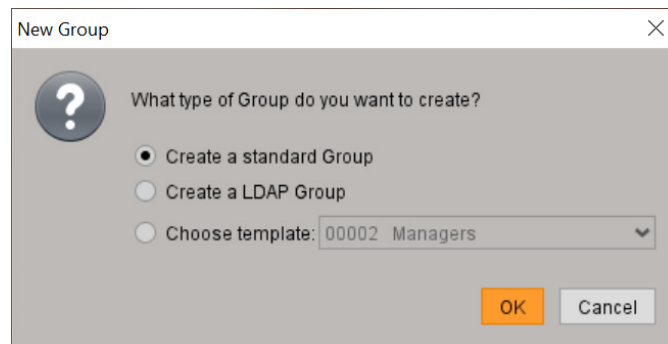

Figure 102. Select New Group type in the Java Tool

4. Enter a name for the group, with up to 16 characters.
5. For LDAP Groups, enter the Common Name (CN) or the organizational unit name (OU) into the field **LDAP OU=/CN=**.
6. Click the **Apply** button to create the group.

To assign a user to a group, proceed as follows:

1. In the **Groups** tab of the **Users & Groups** menu, select a Group to be assigned user(s).
2. Select a user in the list **User/Group available**.
3. Click and drag the selection to the **User/Group assigned** list, or click the right arrow button.
4. Click the **Apply** button to complete the assignment.

## Configuring Extender Settings

When KVM Extenders are connected to the Orion FX matrix, extender units are created automatically. All EXT units can be managed with this menu. It can be accessed in the OSD and the Java Tool.

The extender unit describes the connection of a physical extender to the matrix. Every extender board with a direct cable connection to the matrix is recognized as an extender unit. Dual-Head KVM extenders are recognized as two independent extenders. The data of add-on modules is included in one EXT Unit together with the associated extender module.

The following settings are displayed.

Field	Selection	Description
<b>ID</b>	Number	Numerical value of the extender ID. For KVM Extenders, the ID is the serial number provided by the extender unit, and cannot be changed.
<b>Name</b>	Text	Name of the extender unit
<b>Fixed</b>	Y	Extender unit has a fixed port assignment (default)
	N	Function not active.
<b>Port</b>	1-160 (depending on the Orion FX matrix)	Port number of the extender unit

**Table 36. General Extender Settings**

## Managing Extender Settings through the OSD

- ➔ Select **Configuration** in the main menu and log in.
- ➔ Select **EXT Units** in the **Configuration** menu.

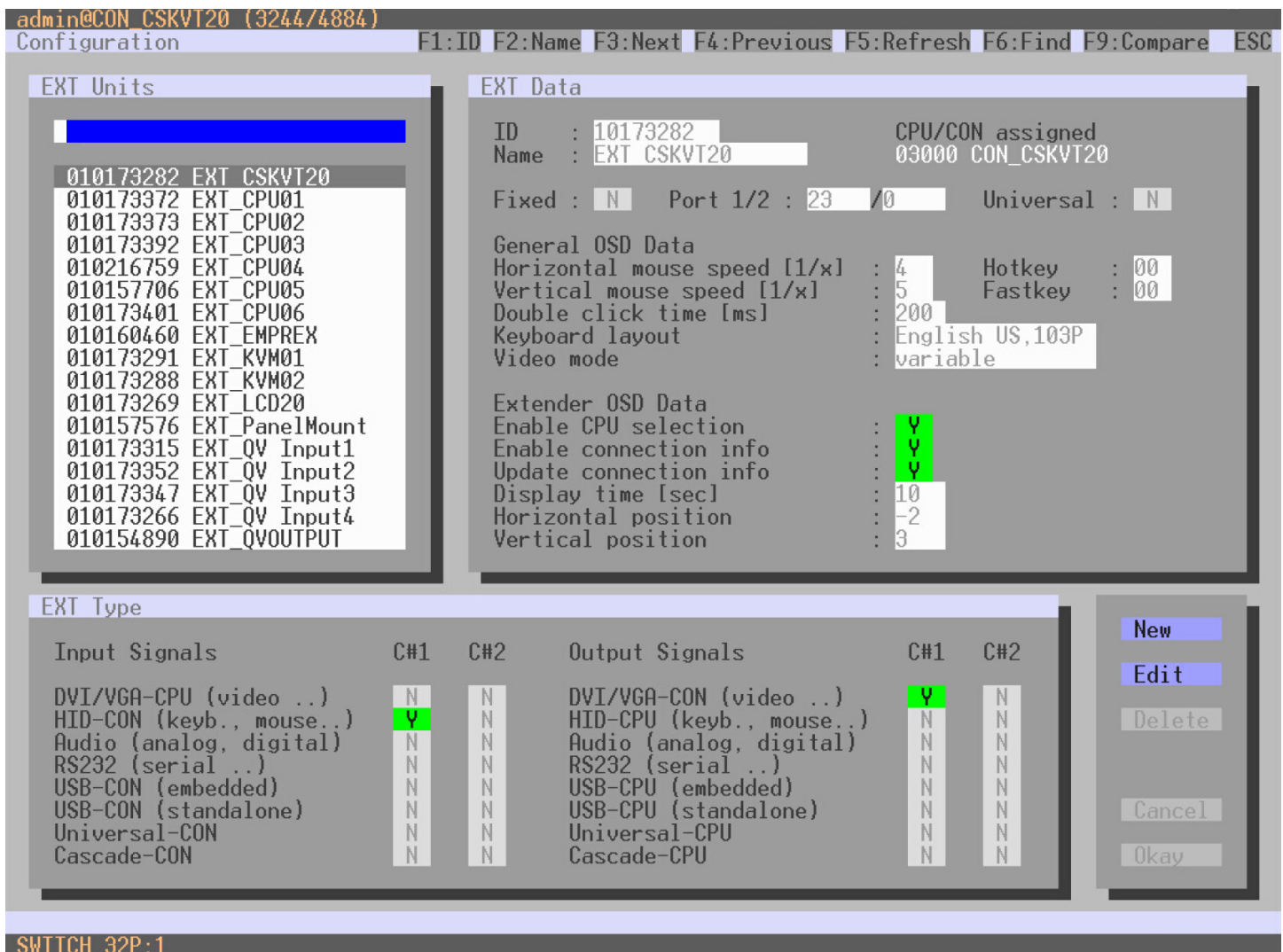

Figure 103. Managing Extender Settings through the OSD

Select between the following buttons:

Button	Function
<b>New</b>	Create a new extender unit
<b>Edit</b>	Edit an existing extender unit
<b>Delete</b>	Delete an existing extender unit
<b>Cancel</b>	Reject changes
<b>Okay</b>	Save Changes

Table 37. Buttons in the OSD Extender Settings Screen

The settings for General OSD Data are described below in the [Mouse and Keyboard](#) section.

## Managing Extender Settings through the Java Tool

➔ In the Task area, under **Extenders and Devices**, select **EXT Units**.

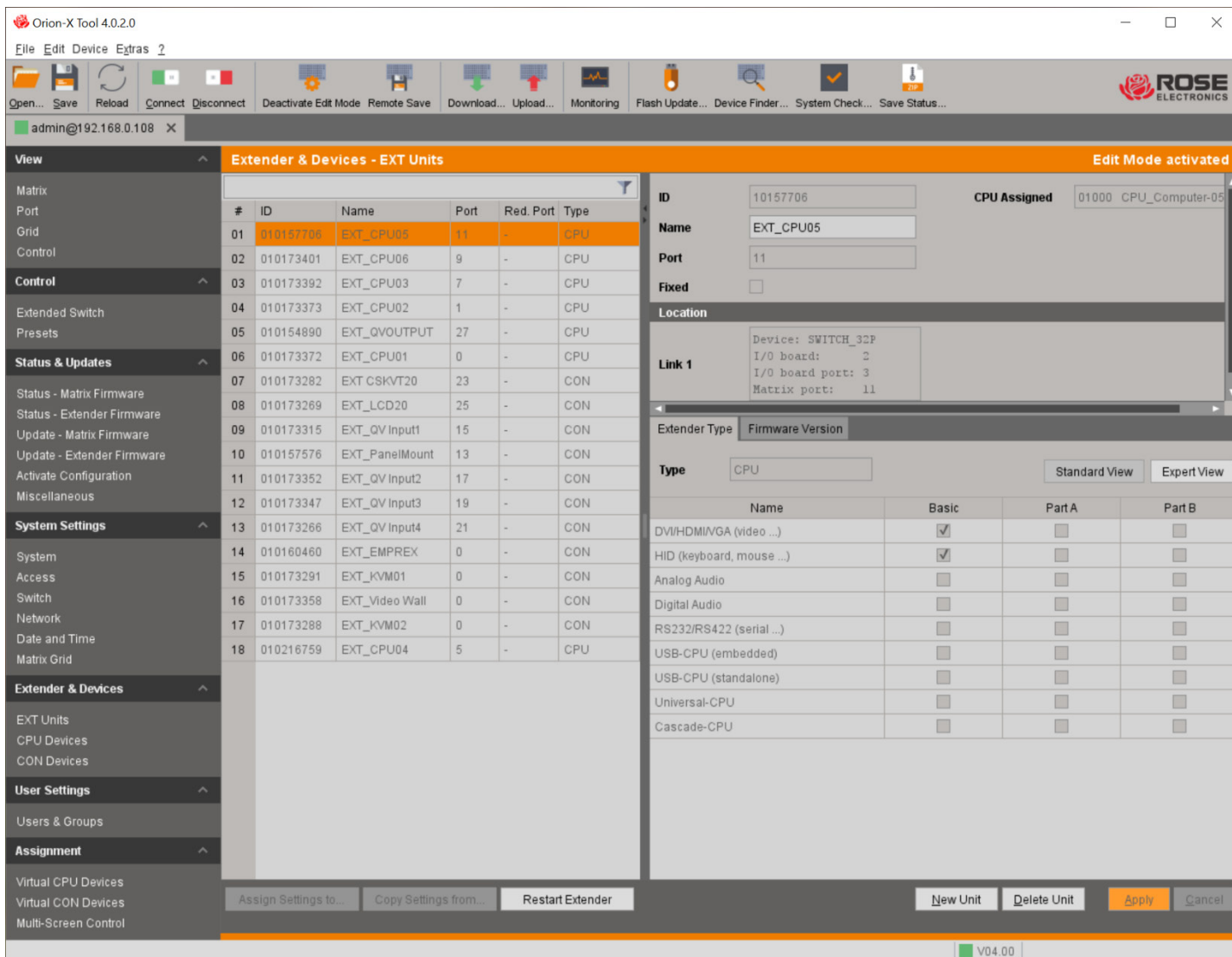

Figure 104. Managing Extender Settings through the Java Tool

Select between the following buttons:

Button	Function
<b>New Unit</b>	Create a new extender unit
<b>Delete Unit</b>	Delete an existing unit
<b>Apply</b>	Confirm changes of an extender unit
<b>Cancel</b>	Reject changes

Table 38. Buttons in the Java Tool Extender Settings Screen

### Flex-Port Extender Units

Many extenders have functionality which is automatically recognized by the system and these extenders cannot be created manually. This is the Flex-Port function of the Orion FX matrix.

**Note:** The connection of a fixed port extender module (e.g. USB 2.0) to a Flex-Port extender can cause unintended results.

## USB 2.0 Extender

This section describes how to configure and use USB 2.0 extenders. These extenders must be connected to standard I/O boards. They can be configured for independent switching, or can be assigned to existing CON or CPU devices. USB 2.0 extenders can be configured through the OSD or the Java Tool.

### Configuring USB 2.0 Extenders through the OSD

- ➔ Select **Configuration** in the main menu and log in.
- ➔ Select **EXT Units** in the **Configuration** menu.

The screenshot shows the OSD Configuration menu with the following sections:

**EXT Units**

- 010173282 EXT\_CSKVT20
- 010173372 EXT\_CPU01
- 010173373 EXT\_CPU02
- 010173392 EXT\_CPU03
- 010216759 EXT\_CPU04
- 010157706 EXT\_CPU05
- 010173401 EXT\_CPU06
- 010160460 EXT\_EMPREX
- 010173291 EXT\_KVM01
- 010173288 EXT\_KVM02
- 010173269 EXT\_LCD20
- 010157576 EXT\_PanelMount
- 010173315 EXT\_QV Input1
- 010173352 EXT\_QV Input2
- 010173347 EXT\_QV Input3
- 010173266 EXT\_QV Input4
- 010154890 EXT\_QVOUTPUT

**EXT Data**

ID : 10173282 CPU/CON assigned  
 Name : EXT\_CSKVT20 03000 CON\_CSKVT20

Fixed : N Port 1/2 : 23 / 0 Universal : N

**General OSD Data**

Horizontal mouse speed [1/x] : 4 Hotkey : 00  
 Vertical mouse speed [1/x] : 5 Fastkey : 00  
 Double click time [ms] : 200  
 Keyboard layout : English US,103P  
 Video mode : variable

**Extender OSD Data**

Enable CPU selection : Y  
 Enable connection info : Y  
 Update connection info : Y  
 Display time [sec] : 10  
 Horizontal position : -2  
 Vertical position : 3

**EXT Type**

Input Signals	C#1	C#2	Output Signals	C#1	C#2
DVI/VGA-CPU (video ..)	N	N	DVI/VGA-CON (video ..)	Y	N
HID-CON (keyb., mouse..)	Y	N	HID-CPU (keyb., mouse..)	N	N
Audio (analog, digital)	N	N	Audio (analog, digital)	N	N
RS232 (serial ..)	N	N	RS232 (serial ..)	N	N
USB-CON (embedded)	N	N	USB-CPU (embedded)	N	N
USB-CON (standalone)	N	N	USB-CPU (standalone)	N	N
Universal-CON	N	N	Universal-CPU	N	N
Cascade-CON	N	N	Cascade-CPU	N	N

Buttons: New, Edit, Delete, Cancel, Okay

SWITCH\_32P:1

Figure 105. Configuring USB 2.0 Extenders through the OSD

To create a USB 2.0 extender definition through the OSD, proceed as follows:

1. Press the **New** button. An extender with an eight-digit ID will be created, starting with digit 9.
2. Assign an appropriate name to the extender in the **Name** field.
3. Enter the I/O port number where the USB 2.0 extender unit is connected to the matrix into the **Port** field.
4. To configure the extender as a CON Unit, set the **USB-CON (standalone)** option to **Y (C#1 of Input Signals)** and confirm by clicking the **Okay** button.

5. To configure the created extender as a CPU Unit, set the **USB-CPU (standalone)** option to **Y (C#1 of Output Signals)**, and confirm by clicking the **Okay** button.
6. Restart the I/O board to activate the USB fixed port for the new EXT unit.
7. Next, either assign the USB 2.0 CON/CPU EXT unit to an existing CON/CPU device, or create a new CON or CPU device.
8. To assign the USB 2.0 CON extender to an existing CON Device, select the existing device, and move the USB 2.0 CON extender from the **EXT available** field into the **EXT assigned** field.
9. Alternatively, to create a new CON device, see [Console Device Settings](#). To create a new CPU device, see [CPU Device Settings](#).
10. If parallel operation is used within the matrix, set the **Release Time** in the **Configuration > Switch** screen to 10 seconds or more (see [Modifying Switch Settings through the OSD](#)).
11. Restart all I/O boards on which USB 2.0 extenders have been configured, or alternatively restart the Orion matrix.

The USB 2.0 extenders are now configured and can be used.

## Configuring USB 2.0 Extenders through the Java Tool

➔ Select **Extenders and Devices > EXT Units** in the task area.

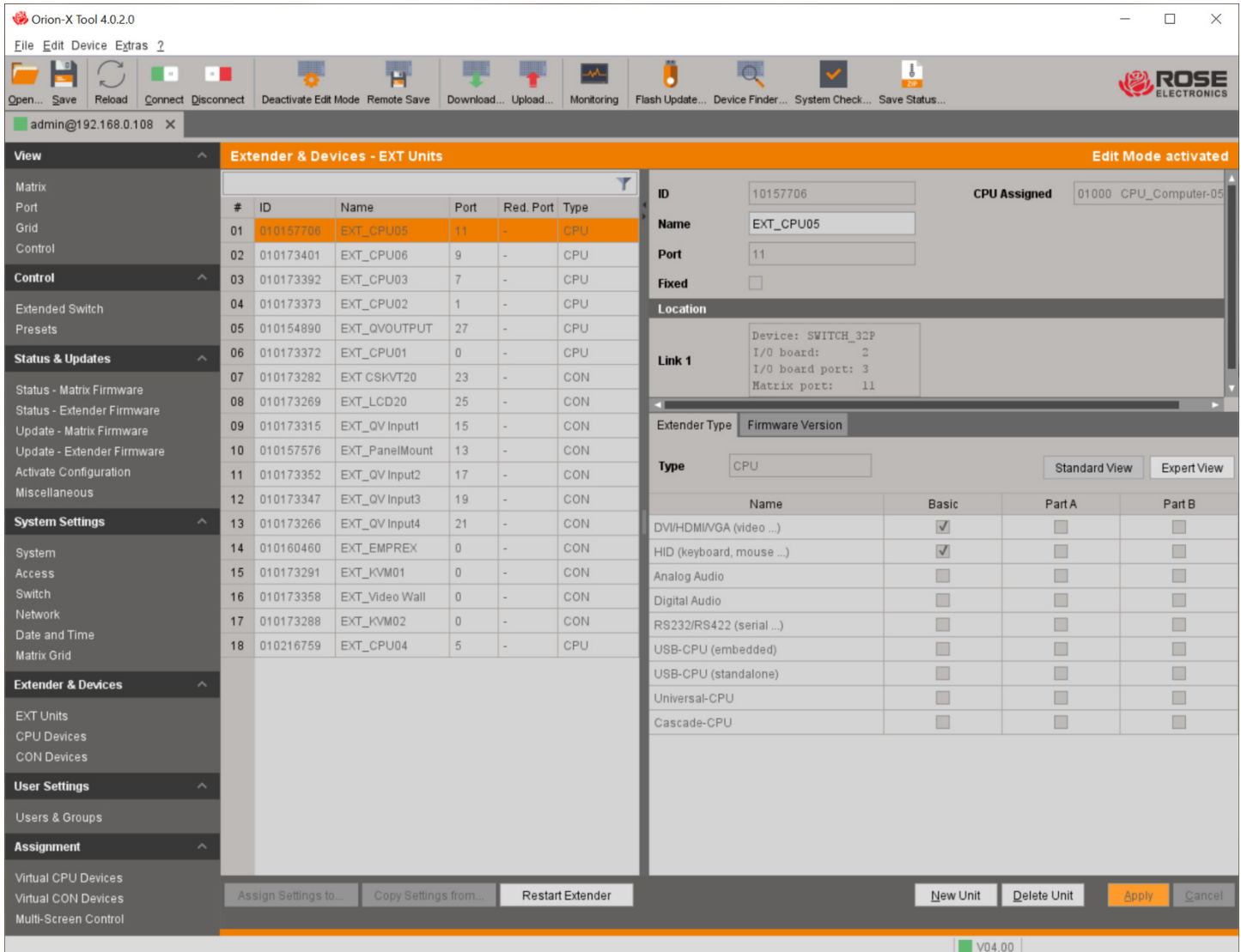

Figure 106. Configuring USB 2.0 Extenders through the Java Tool

1. Click the **New Unit** button. This opens a pop-up window.

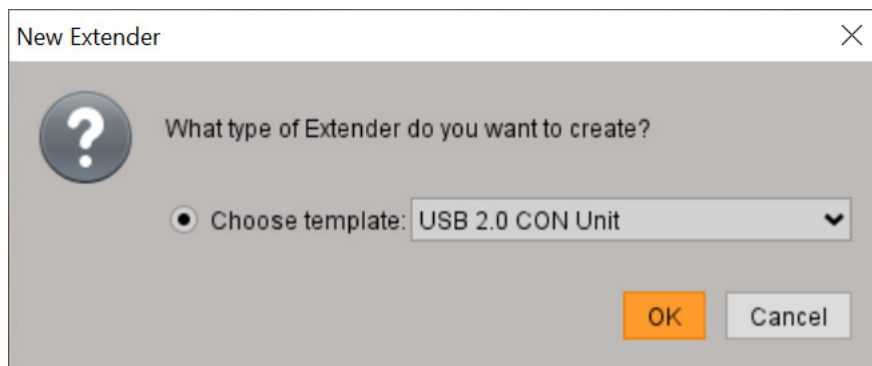
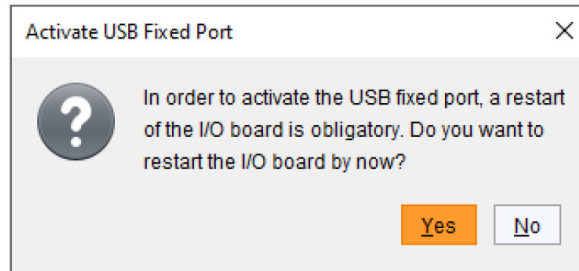

Figure 107. New Extender Unit Type Selection in the Java Tool

2. From the **Templates** in the selection box, select **USB 2.0 CON Unit** or **USB 2.0 CPU Unit** and click the OK button. An extender with an eight-digit ID will be created, starting with digit 9.
3. Enter an appropriate name for the extender in the **Name** field.
4. Enter the port number of the matrix where the USB 2.0 extender is physically connected into the **Port** field.
5. Confirm the settings by pressing the **Apply** button. A pop-up window is displayed.



**Figure 108. Activate Fixed USB Port Dialog**

6. Click the **Yes** button to restart the I/O board and activate the USB fixed port for the new EXT unit. After restart of the I/O board, the parameters and settings of the USB 2.0 extender module are shown in the working area of the respective EXT Unit.
7. The USB 2.0 CPU/CON EXT Unit has to now be either assigned to an existing CPU/CON Device or a new CPU/CON Device has to be created for the assignment:
  - For a **CPU Device** see [CPU Device Settings](#).
  - For a **CON Device** see [Console Device Settings](#).
8. If parallel operation is used within the Orion FX matrix, set the **Release Time** in the **System Settings > Switch** menu to 10 seconds or more (see [Modifying Switch Settings through the Java Tool](#)).
9. Restart all I/O boards on which USB 2.0 extenders have been configured, or restart the matrix.

The USB 2.0 extenders are now configured and can be used.

- Manually created EXT units are always set as fixed port EXT units. This configuration is necessary to, for example, switch USB 2.0 connections through the matrix.
- To make a fixed port available again for Flex-Port EXT units after deleting a fixed port EXT unit, restart the I/O board.

## Configuring CPU Settings

### CPU Device Settings

New CPU devices are defined in this menu, including their assignment to EXT units. The assignment helps to describe and switch more complex computer configurations (e.g. Quad-Head with USB 2.0) in the Orion FX system. This menu can be accessed in the OSD and the Java Tool.

The following settings can be modified.

Field	Selection	Description
<b>ID</b>	Text	ID of the CPU unit
<b>Name</b>	Text	Name of the CPU device
<b>Member of Group</b>	Selection	Assign the CPU device to a group.
<b>Member of Switch</b>	Selection	Assign the CPU input to the respective CPU Switch
<b>Remote CPU</b>	Selection	Assign an IP CPU device to the IP CPU EXT unit
<b>CPU assigned</b>		ID and name of the assigned Virtual CPU Device, automatically retrieved (see <i>Virtual CPU</i> )
<b>Group</b>	Y	Automatically set if the CPU device is assigned to a CPU Group
	N	Function not active (default)
<b>Switch</b>	Y	Automatically set for a CPU Switch
	N	Function not active (default)
<b>Remote Access</b>	Y	Automatically set for an IP CPU Device
	N	Function not active (default)
<b>Virtual Device</b>	Y	Automatically set for a Virtual CPU Device
	N	Function not active (default)
<b>Allow Private</b>	Y	Allow switching to the CPU device in Private Mode
	N	Function not active (default)
<b>Force Private</b>	Y	Force switching to the CPU device in Private Mode only
	N	Function not active (default)
<b>Fix Color</b>	Selection	Show a colored frame when switching to the CPU device (choice of 7 colors).
<b>Reference</b>	Y	Establish a reference CPU device whose device and extender settings can be inherited by any CPU unit when it is initially connected to the matrix. Should be only activated for a single CPU device.
	N	Function not active (default)
<b>2 Step Access</b>	Y	Make a new connection to the CPU device Video Only, and open a pop-up window requiring confirmation to establish a Full Access connection
	N	Function not active (default)
<b>Exclusive Access</b>	Y	Create an access limitation such that when the CPU device already has a Full Access connection, only a higher priority connector can establish a new Full Access connection and take control of keyboard and mouse. Equal priority connectors can only establish Video Only connection. Lower priority connectors are denied connection.
	N	Function not active (default)
<b>MSC disabled</b>	Y	Deactivate Multi-Screen Control function
	N	Activate Multi-Screen Control function
<b>CPU Colors</b>	Selection	The CPU device name will be highlighted according the color setting for test and background (choice of 16 colors).

Table 39. CPU Device Settings

## Modifying CPU Device Settings through the OSD

- Select **Configuration** in the main menu and log in.
- Select **CPU Devices** in the **Configuration** menu.

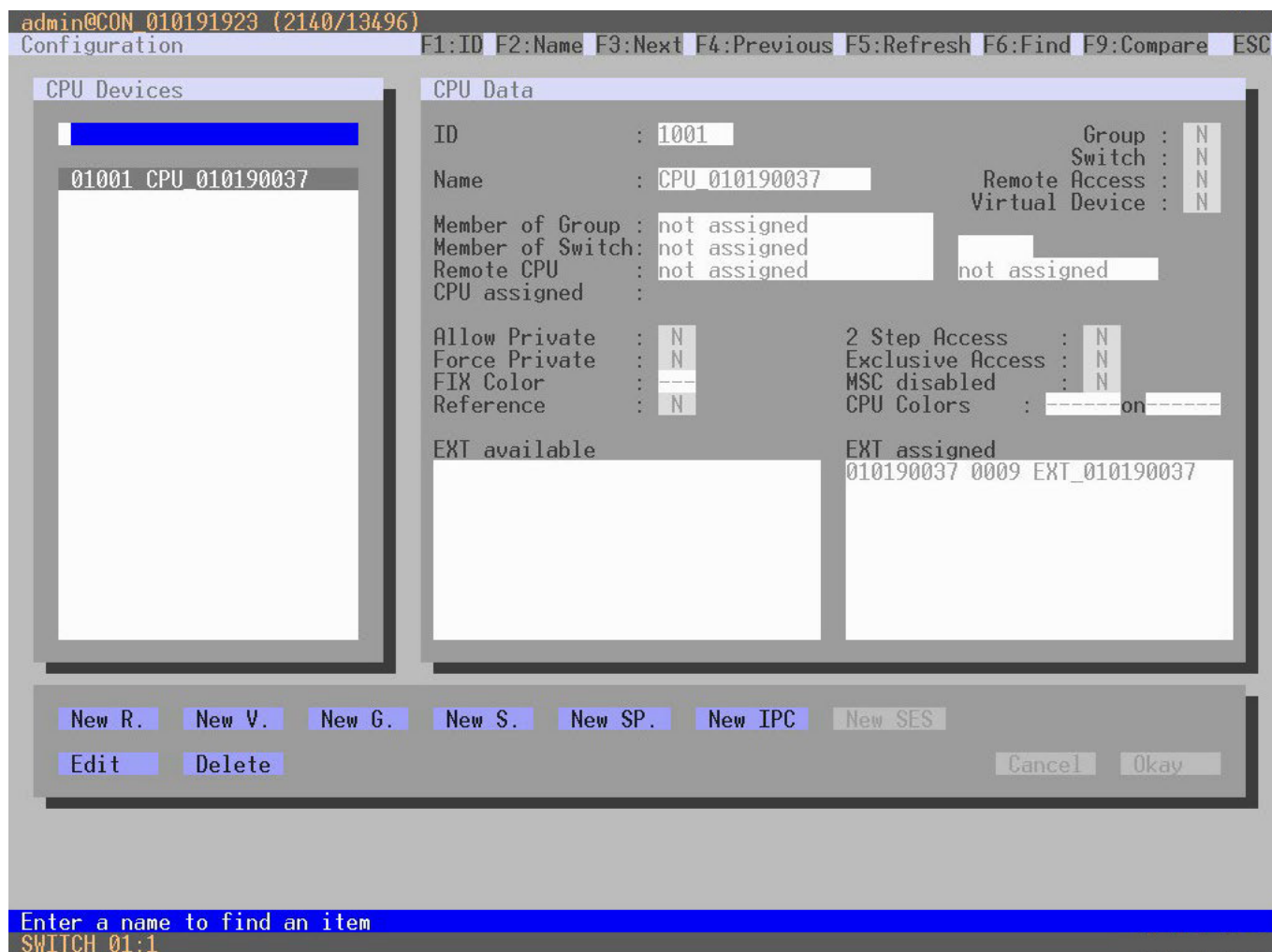

Figure 109. Modifying CPU Device Settings through the OSD

Select between the following buttons:

Button	Function
<b>New R.</b>	Create a new real CPU device
<b>New V.</b>	Create a new virtual CPU device
<b>New G.</b>	Create a new CPU Group
<b>New S.</b>	Create a new CPU Switch
<b>New Sp.</b>	Create a CPU device for a CPU Switch
<b>Edit</b>	Edit an existing CPU device
<b>Delete</b>	Delete an existing CPU device
<b>Cancel</b>	Reject changes
<b>Okay</b>	Save changes

Table 40. Buttons in the CPU Device Settings Screen

To create a CPU Device, proceed as follows:

1. Click the **New R.** button to create a new real CPU Device or click the **New V.** button to create a new virtual CPU Device.
2. Enter a CPU Device name into the field **Name.**
3. Click the **Okay** button.

The CPU Device is now created.

To assign an EXT Unit to a CPU Device, proceed as follows:

1. Select the CPU Device you want to assign an EXT Unit.
2. Select the EXT Unit for the assignment in the **EXT available** list.
3. Click the **Okay** button.

The EXT Unit is now assigned to the CPU Device.

### Modifying CPU Device Settings with the Java Tool

➔ Select **Extenders & Devices > CPU Devices** in the task area.

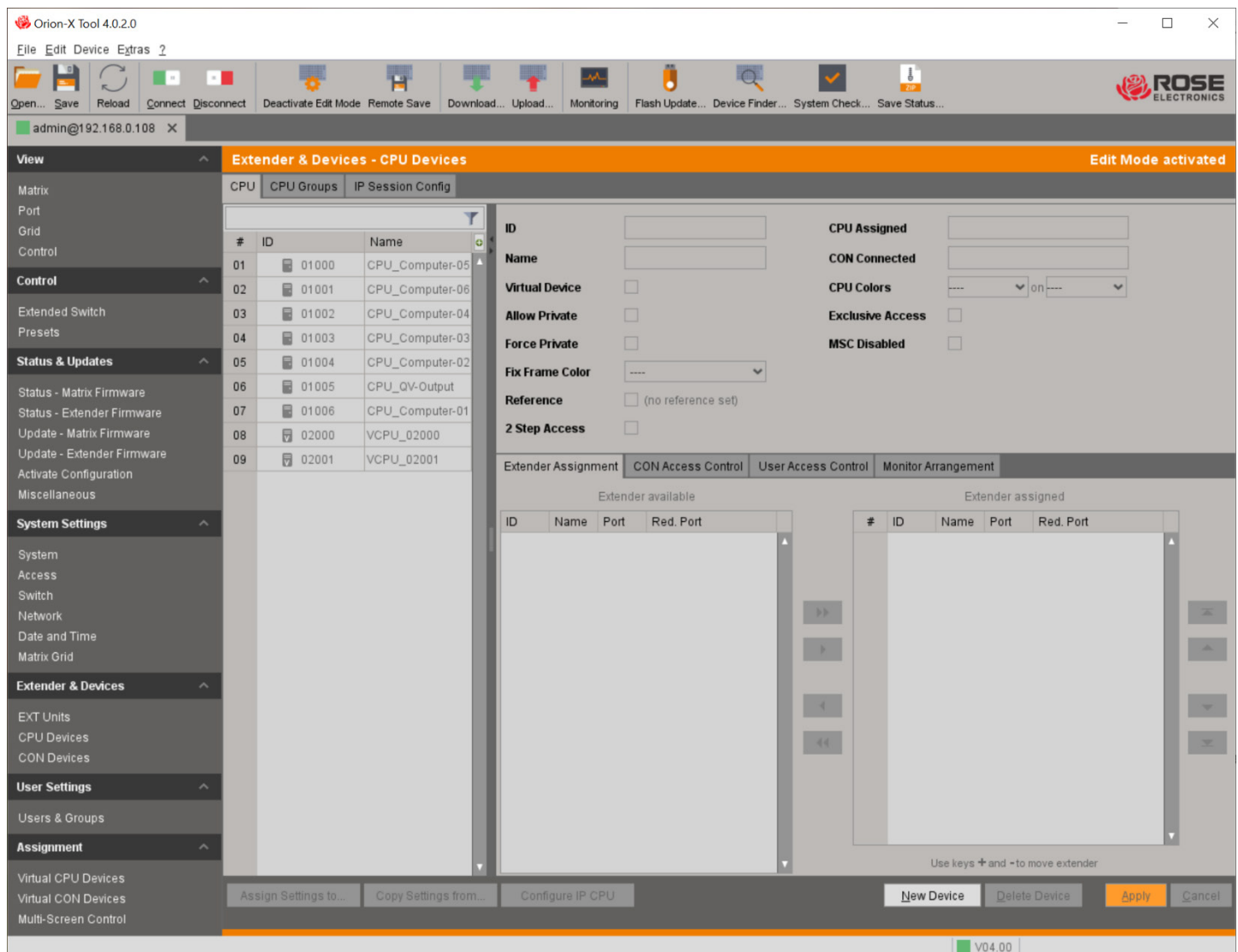

Figure 110. Modifying CPU Device Settings with the Java Tool

Select between the following buttons:

Button	Function
<b>New Device</b>	Open a new CPU Device
<b>Delete Device</b>	Delete a CPU Device
<b>Apply</b>	Confirm a created CPU Device
<b>Cancel</b>	Reject changes
▶	Assign selected extender units
▶▶	Assign all available extender units
◀	Remove the selected extender units
◀◀	Remove all extender units
▼	Change assignment number of the EXT unit downwards
▲	Change assignment number of the EXT unit upwards
◀▲	Change assignment number of the EXT unit to first position
▼▲	Change assignment number of the EXT unit to last position

**Table 41. Buttons in the Java Tools CU Device Settings Screen**

The following keyboard commands can be used.

Function	Keyboard Command
Change assignment number of the EXT unit upwards	<+>
Change assignment number of the EXT unit downwards	<->

**Table 42. Keyboard Commands in the Java Tool CPU Device Settings Screen**

To create a new CPU device, proceed as follows:

1. Click the **New Device** button. A pop-up window lists type choices.

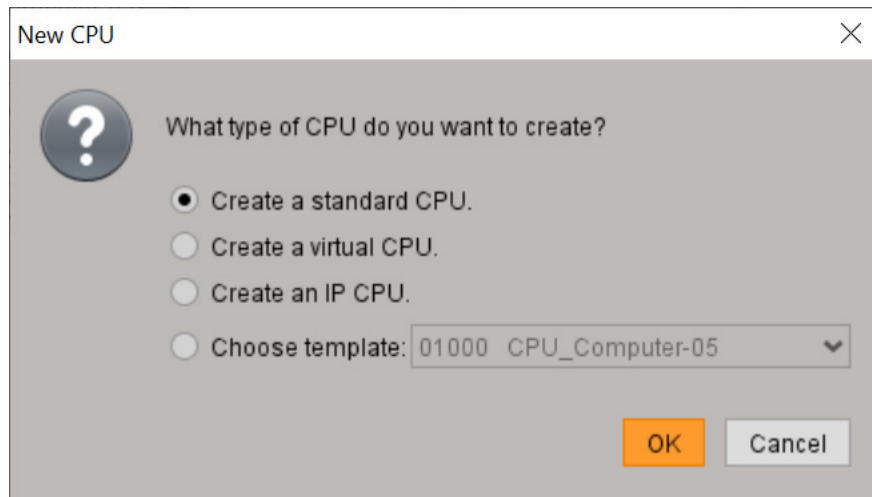

Figure 111. New CPU Device Dialog in the Java Tool

2. Select between the choices available (a template requires at least one existing CPU device).
3. Click the OK button and a new CPU device is created.
4. Select the desired parameters for the new CPU device.
5. Click the Apply button to create the CPU device

To access a new CPU from the Orion FX matrix, an assignment of one or more CPU EXT units is required. Proceed as follows:

1. Select the new CPU in the **CPU Devices** list.
2. Select one or more extenders in the **Extender available** list.
3. Perform the assignment by clicking the ► button. To assign all available extenders to the CPU, click the ►► button. The assignments are displayed in the **Extender assigned** list.
4. Confirm the assignment by clicking the **Apply** button.

To remove an extender assignment, proceed as follows:

1. Select a CPU in the **CPU Devices** list.
2. Select one or more extenders in the **Extender assigned** list.
3. Remove the assignment with the ◀ button. To remove all existing assignments, click the ◀◀ button.
4. Confirm the removal with the **Apply** button.

## CPU Groups

The Orion FX allows multiple CPU devices to be configured as a CPU Groups. The groups can be used to logically or thematically aggregate the CPU Devices. For example, all CPU Devices that are connected to a specific matrix in a matrix grid could be grouped together. The configuration of CPU groups can increase the clarity of the Orion FX configuration. This menu can be accessed in the OSD and the Java Tool.

The following settings can be modified.

Field	Selection	Description
<b>ID</b>	Text	ID of the CPU group
<b>Name</b>	Text	Name of the CPU group
<b>Member of Group</b>	Selection	Assign the CPU device to a group.
<b>Group</b>	Y	Automatically set if the CPU Device is assigned to a CPU Group
	N	Function not active (default)

Table 43. CPU Group Settings

### Creating and Modifying CPU Groups with the OSD

- Select **Configuration** in the main menu and log in.
- Select **CPU Devices** in the **Configuration** menu.

Select between the following buttons.

Button	Function
<b>New G.</b>	Create a new CPU group
<b>Edit</b>	Edit an existing CPU group
<b>Delete.</b>	Delete an existing CPU Group
<b>Cancel</b>	Reject changes
<b>Okay</b>	Save changes

Table 44. Some Buttons in the CPU Device Settings Screen

To create a new CPU group, proceed as follows.

1. Click the **New G.** button
2. Enter a name for the group in the **Name** field.
3. Click the **Okay** button.

The CPU Group has been created.

To assign a CPU Device to a group, proceed as follows:

- Select **CPU Devices** in the **Configuration** menu.
  1. Select the CPU Device to assign to a CPU Group.
  2. Select the CPU Group in the field **Member of Group** using the cursor up and down keys.
  3. Click the **Okay** button.

The CPU Device is now assigned to the CPU Group.

## Creating and Modifying CPU Groups with the Java Tool

➔ Select **Extenders & Devices > CPU Devices** in the task area.

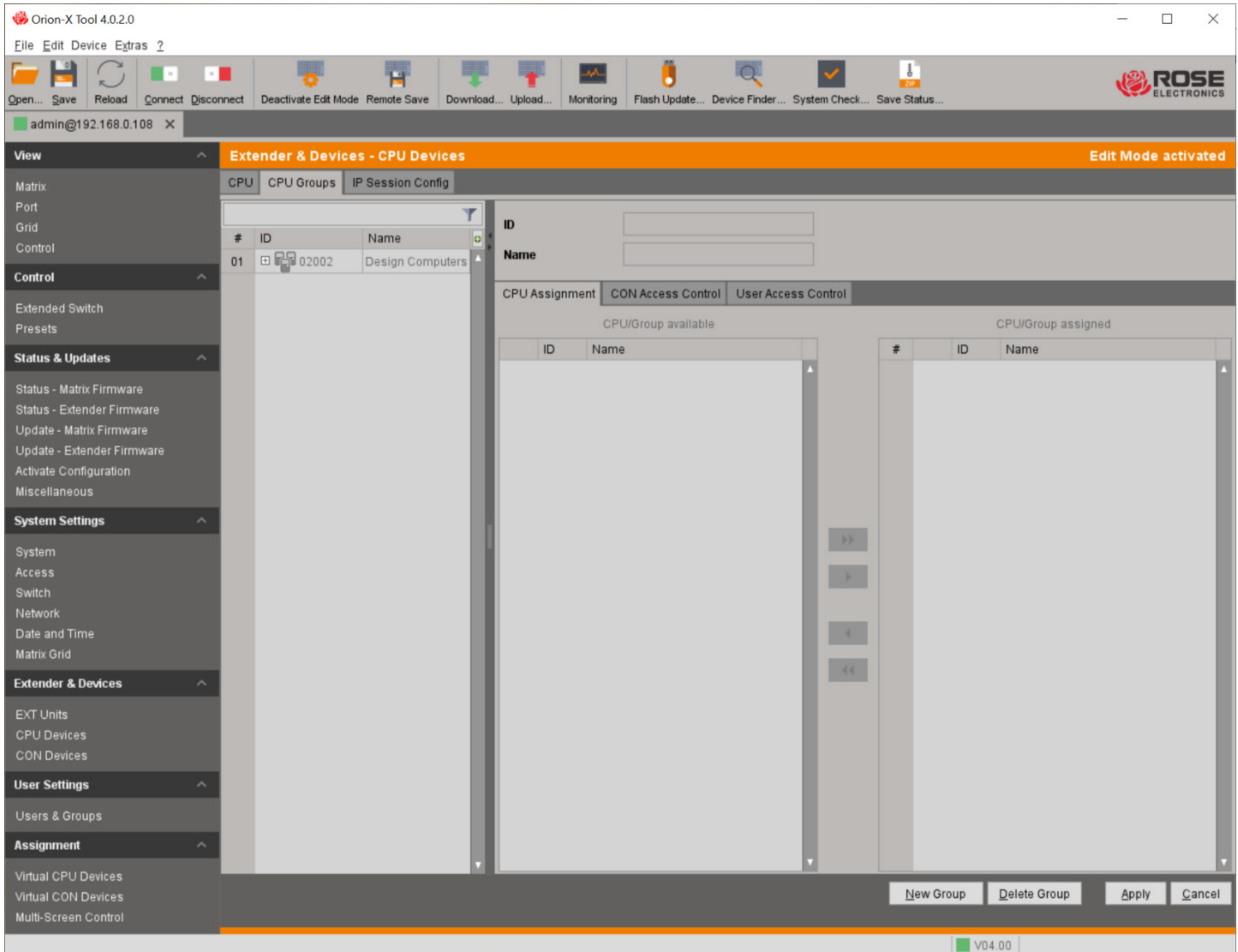

Figure 112. Creating and Modifying CPU Groups with the Java Tool

Follow the steps below to create a new CPU Group using the Java Tool.

1. Select the **CPU Groups** tab in the working area.
2. Click the **New Group** button.
3. If any **CPU Groups** were previously created, a pop-up window will open.

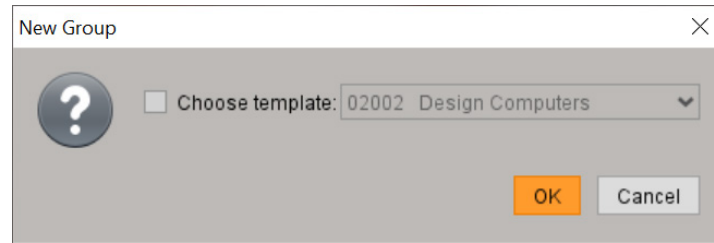

Figure 113. CPU Group Template Pop-Up Menu in the Java Tool

4. Select an existing Group as a template, or just click on the **OK** button.
5. Enter a name for the Group in the field **Name**.
6. Click the **Apply** button, and the Group is created.

To assign a CPU Device to a CPU Group, proceed as follows:

1. Select the **CPU Groups** tab in the working area of the **Extenders & Devices > CPU Devices** menu.
2. Select the **CPU Group** to be assigned a **CPU Device**.
3. Select a CPU Device to be assigned to the group in the **CPU/Group available**.
4. Either click and drag the selection to the **CPU/Group assigned** list or click the right arrow button.
5. Click the **Apply** button to save the assignment.

## Configuration of a CPU Switch

The CPU Switch is an 8:1 port concentrator for up to eight computer sources connected by VGA and USB HID (keyboard and mouse). It can be specifically configured for use with an Orion FX. The configuration allows individual switching of up to eight input signals with the OSD. This menu is available in the OSD.

The following settings can be modified.

Field	Selection	Description
<b>ID</b>	Text	ID of the CPU device
<b>Name</b>	Text	Name of the CPU device
<b>Member of switch</b>	Selection	Assign the CPU input to the respective CPU Switch
<b>Switch</b>	Y	Automatically set for a CPU Switch
	N	Function not active (default)

Table 45. CPU Group Settings

### Configuring a CPU Switch with the OSD

- Select **Configuration** in the main menu and log in.
- Select **CPU Devices** in the **Configuration** menu.

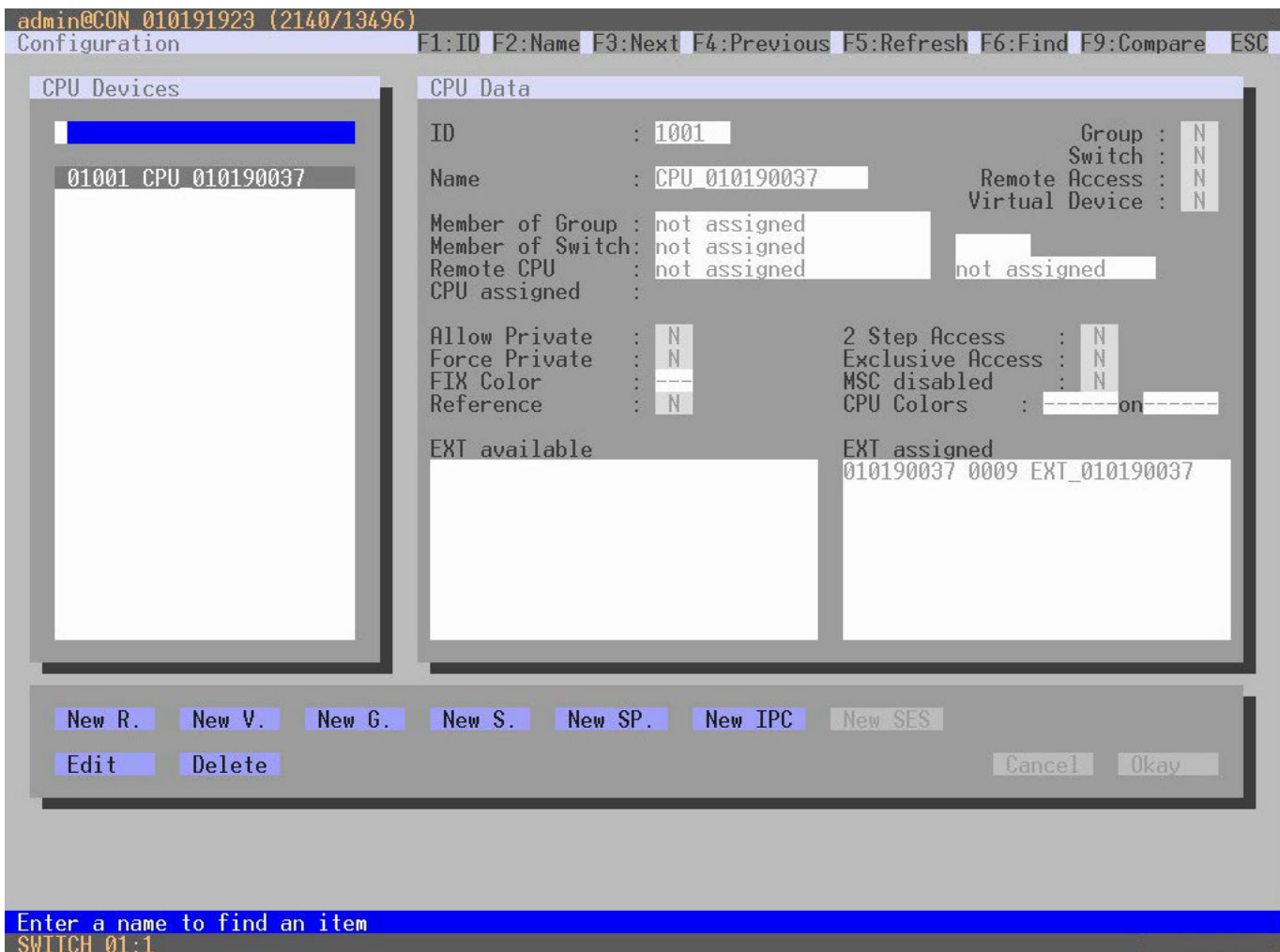

Figure 114. Configuring a 484 Series Switch with the OSD

Select between the following buttons.

Button	Function
<b>New S.</b>	Create a new CPU Switch
<b>New SP.</b>	Create a CPU EXT Unit for a CPU Switch
<b>Edit</b>	Edit an existing CPU group
<b>Delete.</b>	Delete an existing CPU Group
<b>Cancel</b>	Reject changes
<b>Okay</b>	Save changes

**Table 46. Some Buttons in the CPU Device Settings Screen**

Follow the steps below to set up a new CPU switch.

1. Click the **New S.** button.
2. Enter a name for the switch in the **Name** field.
3. Assign an EXT Unit to the CPU Switch in the **EXT Assigned** field.
4. Click the **New SP.** button. A new CPU (input) for a CPU Switch will be created (port 1).
5. Assign the newly created CPU to a CPU Switch in the field **Member of Switch**.
6. Repeat steps 4 and 5 for each input port in use on the CPU Switch.
7. Click the **Okay** button. The CPU switch is now configured and can be individually switched with the OSD.

## Virtual CPU

Orion FX allows CPU specific assignments. Assigning virtual CPUs to real CPUs simplifies the process of switching several consoles to the same CPU. If several consoles are switched to a virtual CPU which is assigned to a real CPU, the change only has to be done once, and all consoles will receive the video signal of the real CPU. It is possible to assign one or several real CPUs to a virtual CPU, but only one virtual CPU can be assigned to a real CPU. This can be done through the OSD or the Java Tool.

### Assignment of Virtual CPUs through the OSD

→ Select **Assignments > Virtual CPU devices** in the main menu.

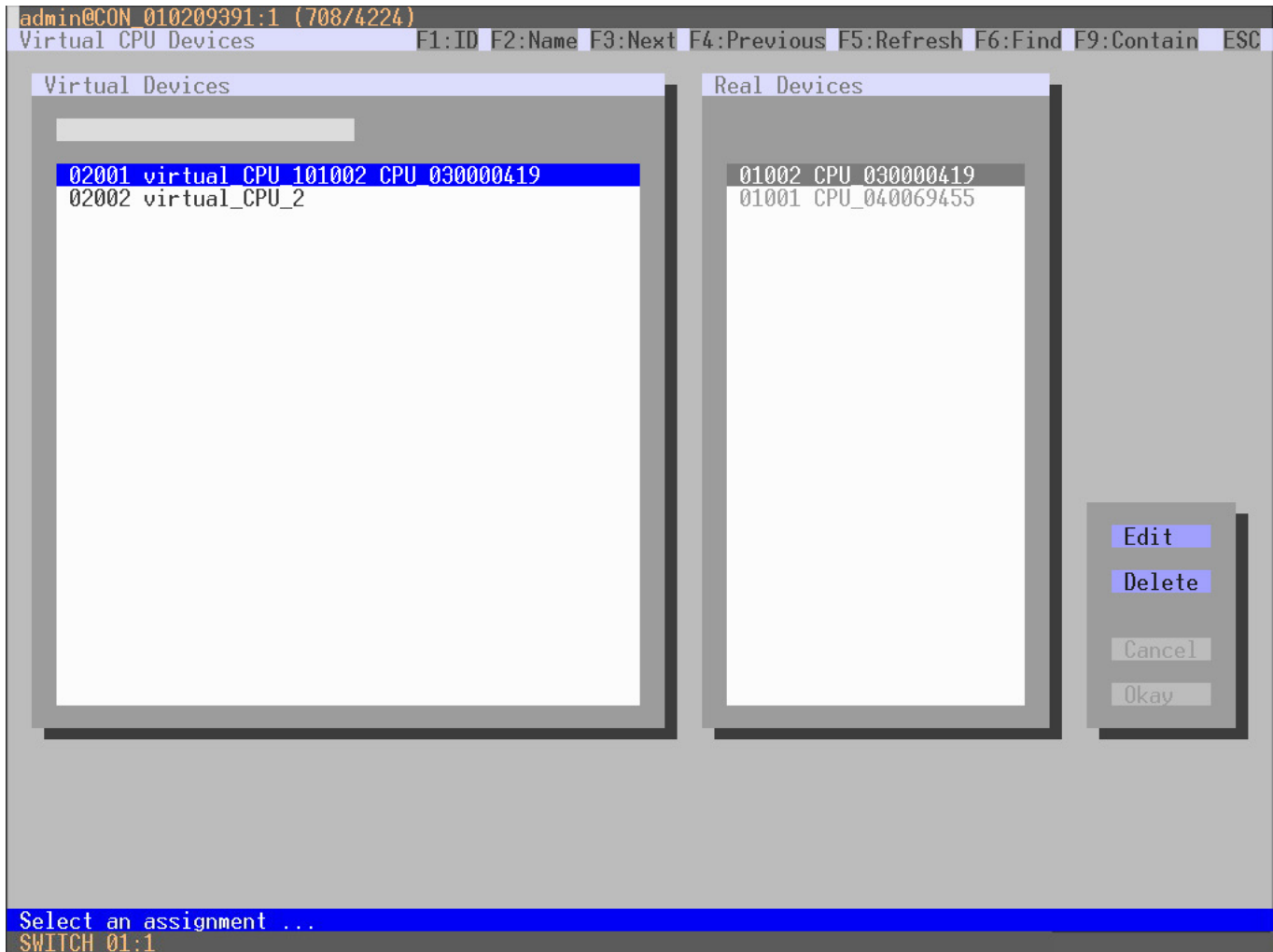

Figure 115. Virtual CPU Device Assignment through the OSD

To make an assignment, proceed as follows:

1. Select the Virtual CPU in the **Virtual Devices** list that is to be assigned to a real CPU.
2. Click the **Edit** button.
3. Select the CPU in the **Real Devices** list that is to be assigned to the selected virtual CPU.
4. Click the **Okay** button to confirm the assignment.

## Assignment of Virtual CPUs through Java Tool

➔ Select **Assignment > Virtual CPU Devices** at the bottom of the task area on the left of the Java Tool.

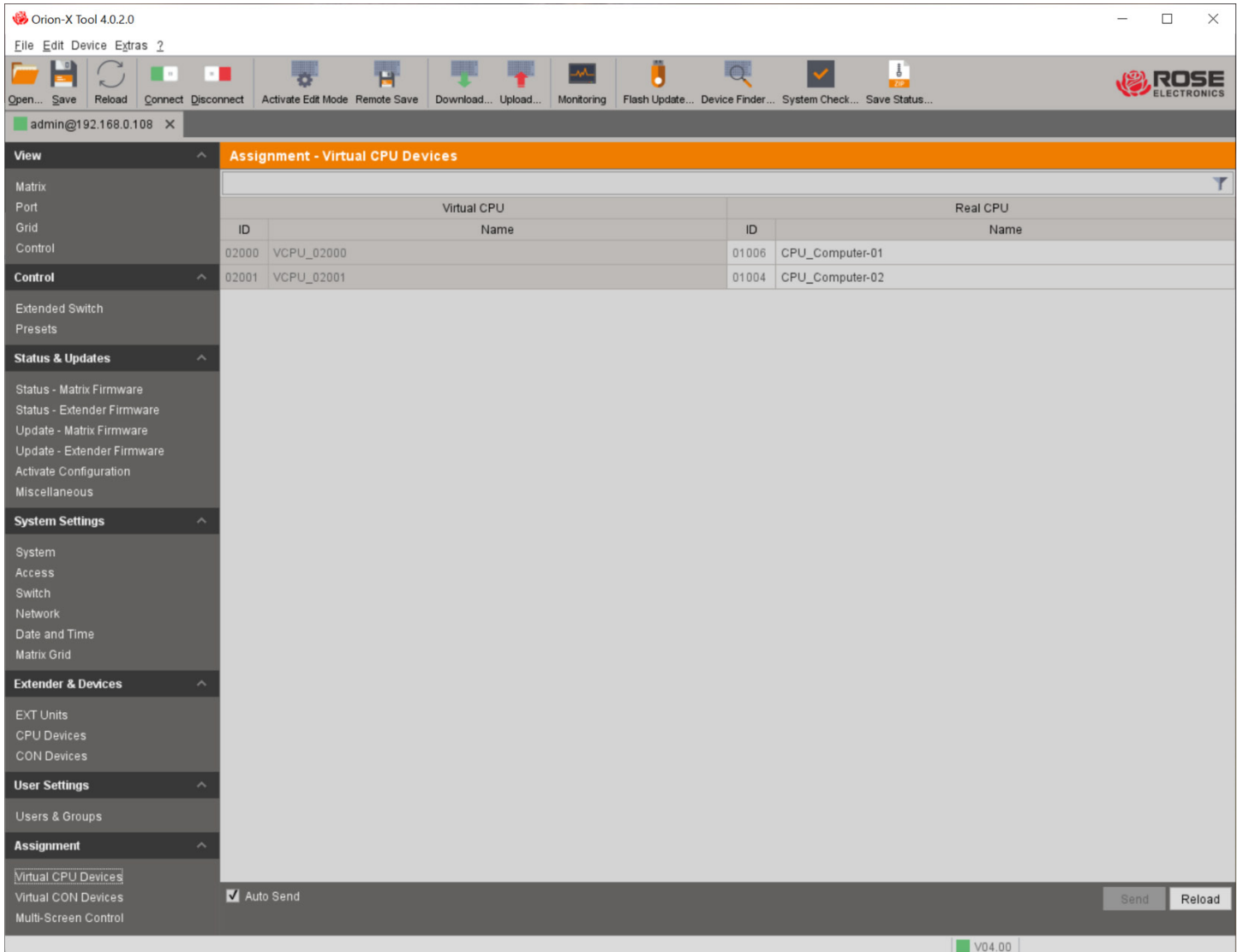

Figure 116. Virtual CPU Devices Assignment through Java Tool

To make an assignment, proceed as follows:

1. Select a virtual CPU in the **Virtual CPU** list.
2. Double click in the **Real CPU** column to get a list of all available real CPUs.
3. Select a real CPU.
4. Click the **Send** button to send the assignment to Orion FX.

When the **Auto Send** checkbox in the left lower corner of the working area is ticked, switching operations will be performed immediately, without user confirmation by clicking the Send button.

There is a blank field just above the Virtual CPU and Real CPU lists, which can be used to enter characters to filter long lists of devices. Only those devices which match the entered characters are displayed.

The Java Tool additionally offers the option to switch directly from the **Assignment** menu to the **Definition** menu to check specific settings for the CPU in question.

➔ Use the right mouse button to select the desired CPU, and select **Open CPU Device**.

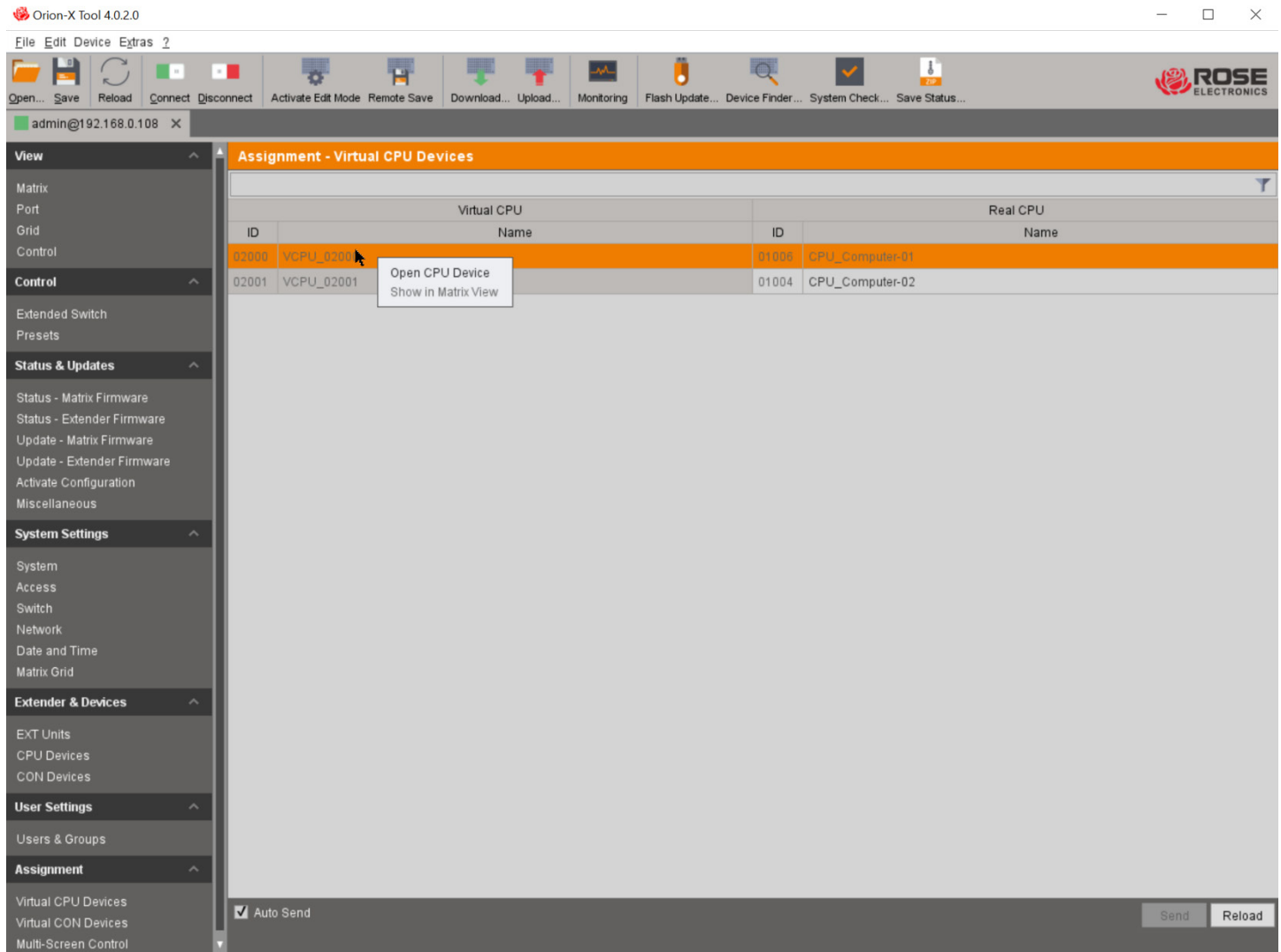

Figure 117. Open CPU device in Assignment Virtual CPU Menu

## Configuring Console Settings

### Console Device Settings

New CON devices are created with this menu, including access rights and extender assignments. The menu can be accessed in the OSD and the Java Tool.

The following settings can be modified.

Field	Selection	Description
<b>ID</b>	Text	ID of the CON Unit
<b>Priority</b>	0-999	Priority of the CON Device There is no keyboard/mouse sharing between CON Devices with different priorities, so release time does not apply. If a CON device with a higher priority is already connected to a CPU Device, the lower priority CON Device will have Video Only access.
<b>Name</b>	Text	Name of the CON Device
<b>Show Macro List</b>	Y	Show the macro list instead of the CPU selection list
	N	Function not active (default)
<b>Allow User ACL</b>	Y	Allow activation of the User Access Control List at the local console (see <a href="#">Access Control</a> )
	N	Function not active (default)
<b>Force Login</b>	Y	Force user login at this CON device <b>Note:</b> Console ACL remains active. When a user is logged in, only the user favorites are accessible, not the CON favorites.
	N	Function not active (default)
<b>LOS Frame</b>	Y	<ul style="list-style-type: none"> <li>When the video signal is lost between source and the CPU Unit, or the connection between matrix and the CON Unit is lost, an orange frame will be displayed.</li> <li>When switching to a CPU unit without a video signal, a blank screen will appear surrounded by an orange frame</li> </ul>
	N	Function not active (default)
<b>Disable OSD</b>	Y	Disable OSD access for the CON Device
	N	Function not active (default)
<b>CPU Colors</b>	Selection list	The connected CPU Device name will be highlighted according to the color setting for text and background. Select between 16 colors.
<b>Virtual Device</b>	Y	Automatically set for Virtual CON device
	N	Function not active (default)
<b>Allow CPU Scan</b>	Y	Allow scan mode, where the CON Device's favorites list or a logged-in user's favorites list, can be cycled through automatically at the CON Device
	N	Function not active (default)
<b>Force CPU Scan</b>	Y	Force continuous timed change of connection CPUs, using the CON Device's favorites list or a logged-in user's favorites list. <b>Note:</b> Active scanning can be stopped by a mouse or keyboard event. Full Access to the currently connected CPU device is granted if Force Connect is also active.
	N	Function not active (default)
<b>Scan Time [sec]</b>	0-99 seconds	Length of time before scan mode switches to the next CPU in the list

Field	Selection	Description
<b>Port Mode</b>	Y	The favorites list is replaced by a port list where ports from 1-999 can be directly selected at each matrix or Matrix grid. <b>Note:</b> This selection only applies to CPU Devices. CON and User favorites lists are deactivated when using Port Mode.
	N	Function not active (default)
<b>Redundancy Off</b>	Y	Do not automatically switch to the second link of a connected redundant CON Unit if the primary link to a CPU Unit is lost.
	N	Switching to redundant links at link loss is active (default).
<b>Reference</b>	Y	Make this device a reference CON Device that passes both Device and extender settings to any CON unit connecting to Orion FX for the first time. Only activate this setting for a single CON Device.
	N	Function not active (default)
<b>Fix Color</b>	Selection list	Show a colored frame on the video of a connected CPU device. Selection between 7 colors. The colored frame of the CPU device has priority over the colored frame of the CON device.

**Table 47. CON Device Settings**

## Setting up CON Devices through the OSD

- Select **Configuration** in the main menu and log in.
- Select **CON Devices** in the **Configuration** menu.

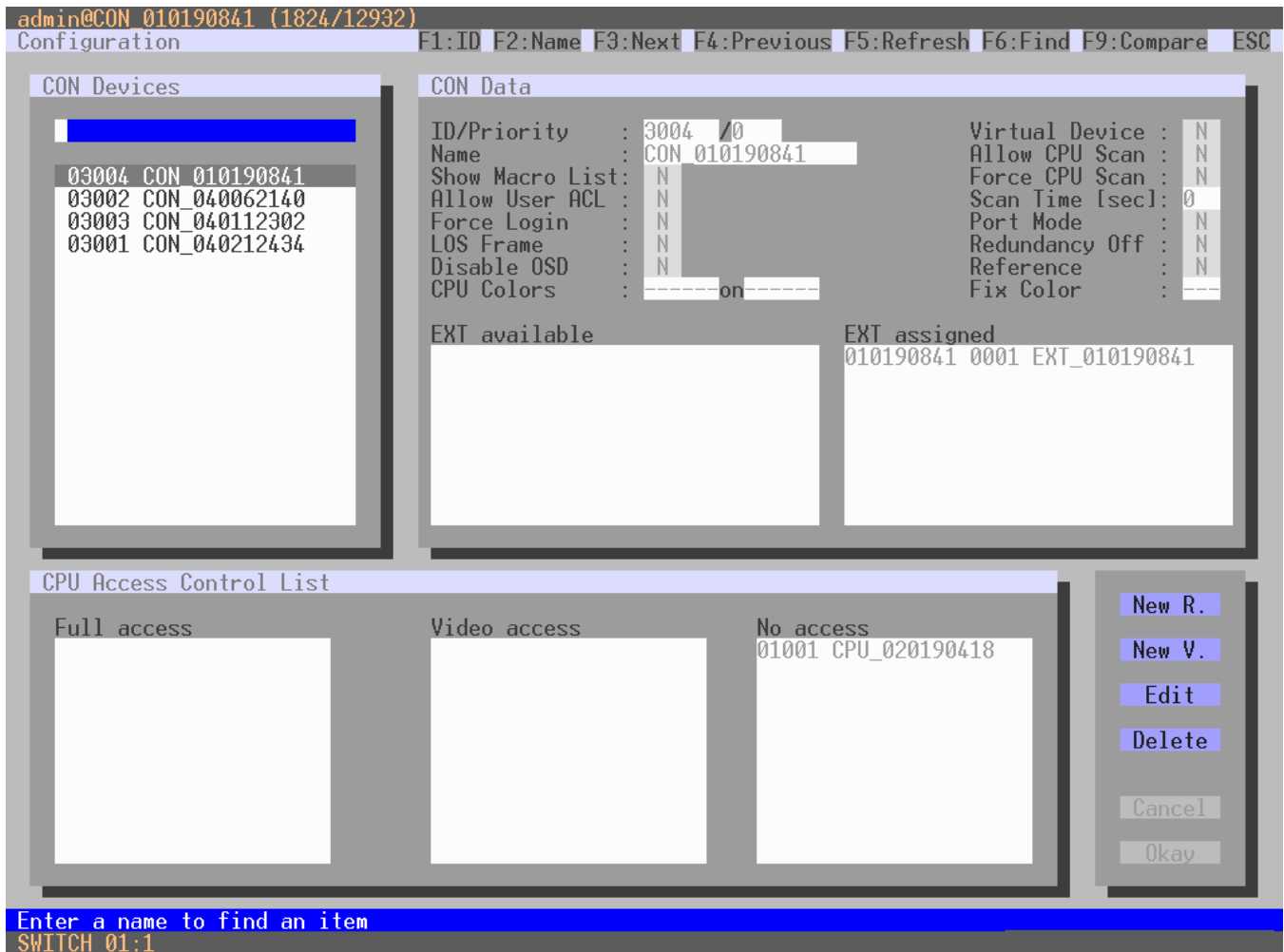

Figure 118. Setting Up CON Devices through the OSD

To create a CON Device, proceed as follows:

1. Click the **New R.** button to create a new Real CON Device, or click the **New V.** button to create a new Virtual CON Device. (For a description on Real and Virtual Consoles, see [Virtual Console](#)).
2. Enter a CON Device name into the field **Name**.
3. Click the **Okay** button.

The CON Device is created.

To assign an EXT Unit to a CON Device, proceed as follows:

1. Select the CON Device you want to assign to an EXT Unit.
2. Select the EXT Unit for the assignment in the **EXT available** list.
3. Click the **Okay** button.

The CON Device is assigned to the EXT Unit.

## Setting up CON Devices through the Java Tool

➔ Select **Extender & Devices > CON Devices** in the task area.

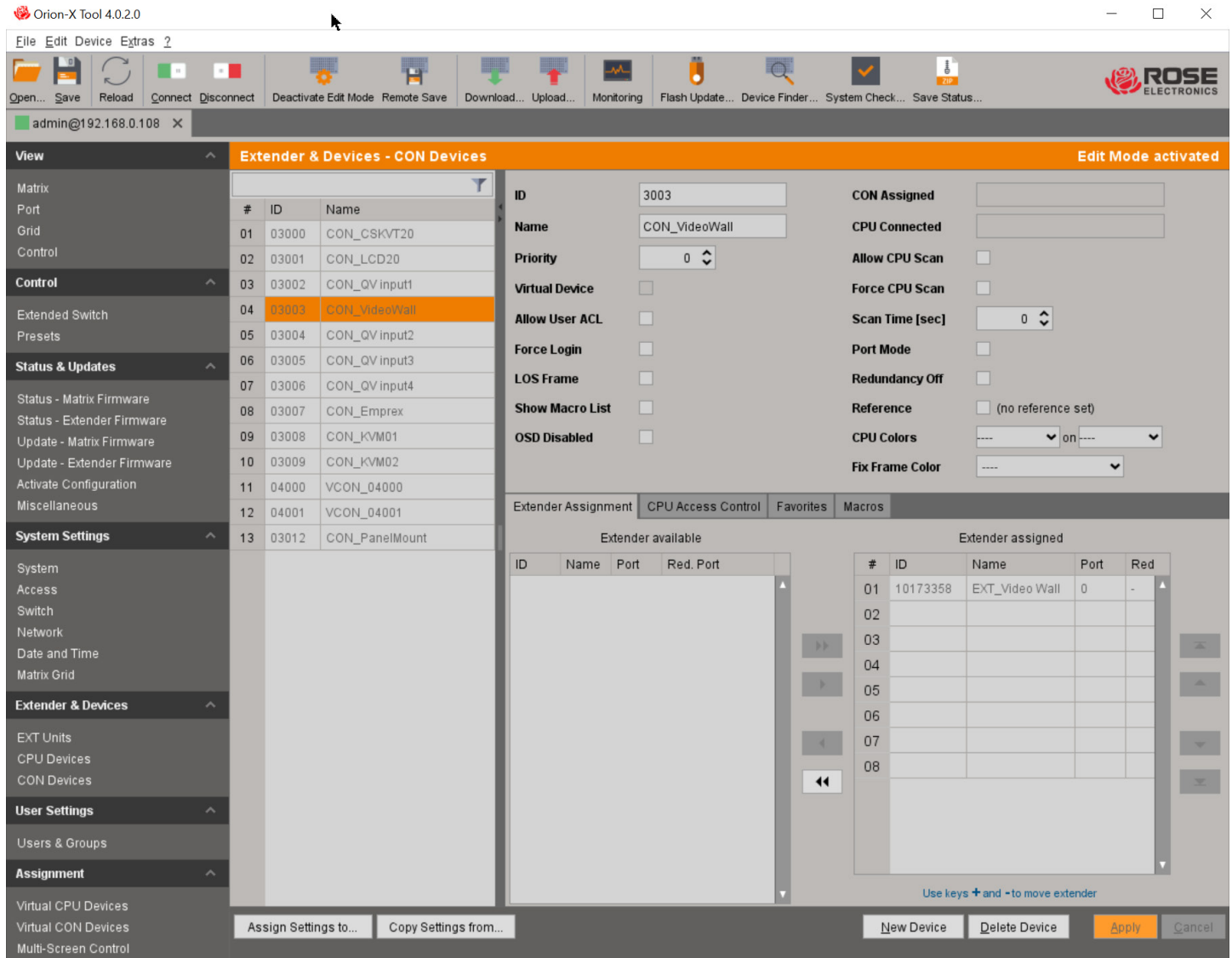

Figure 119. Setting Up CON Devices through the Java Tool

Select between the following buttons:

Button	Function
<b>New Device</b>	Create a new CON Device
<b>Delete Device</b>	Delete a CON Device
<b>Apply</b>	Confirm a created CON Device
<b>Cancel</b>	Reject changes
▶	Assign selected extender units
▶▶	Assign all available extender units
◀	Remove the selected extender units
◀◀	Remove all extender units

Table 48. Buttons in the Java Tool CON Devices Screen

The following keyboard commands can be used.

Function	Keyboard Command
Change assignment number of the EXT unit upwards	<+>
Change assignment number of the EXT unit downwards	<->

**Table 49. Keyboard Commands in the Java Tool CON Devices Screen**

To create a new console, proceed as follows:

1. Click the **New Device** button.
2. In the pop-up menu, select **Create a real Console**, **Create a virtual Console**, or **Choose template** if an existing console should be used as a template.

**Note:** A template can only be selected if there is at least one existing CON device.

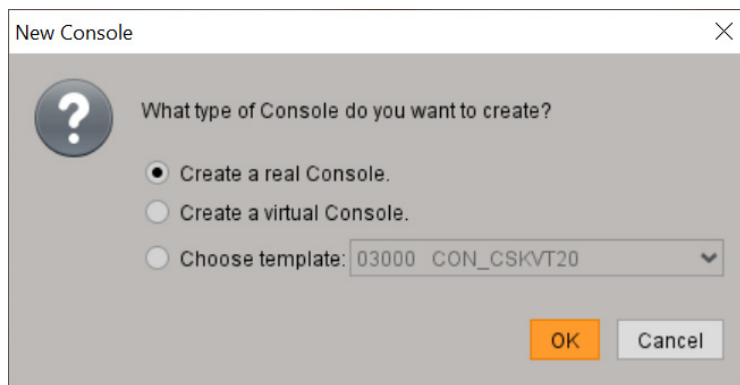

**Figure 120. New CON Device Type**

3. Click the **OK** button.
4. Make the appropriate parameter selections for the console.
5. To confirm the creation of the new console, click the **Apply** button.

One or more CON EXT Units must be assigned to the console device for it to access a CPU through the matrix. To make an extender assignment, proceed as follows.

1. Select the console in the **CON Devices** list to be assigned an extender.
2. Click the **Extender** Assignment tab, and select from the unassigned extenders in the **Extender available** list to assign to the CON Device.
3. Perform the assignment by clicking the ► button. To assign all available extenders to the console, click the ►► button. The assignments are displayed in the **Extender assigned** list.
4. Confirm the assignment by clicking the **Apply** button.

To remove an extender assignment, proceed as follows:

1. Select the console to modify in the **CON Devices** list.
2. Select the extender to be removed from assignment to the console in the **Extender assigned** list.
3. Remove the assignment with the ◀ button. To remove all existing assignments, click the ◀◀ button.
4. Confirm the removal with the **Apply** button.

To configure a console's CPU access rights, proceed as follows:

1. Select a console in the **CON Devices** list.
2. Select the **CPU Access Control** tab.
3. Assign access rights by using the right mouse button or the appropriate keyboard commands (see the table below).

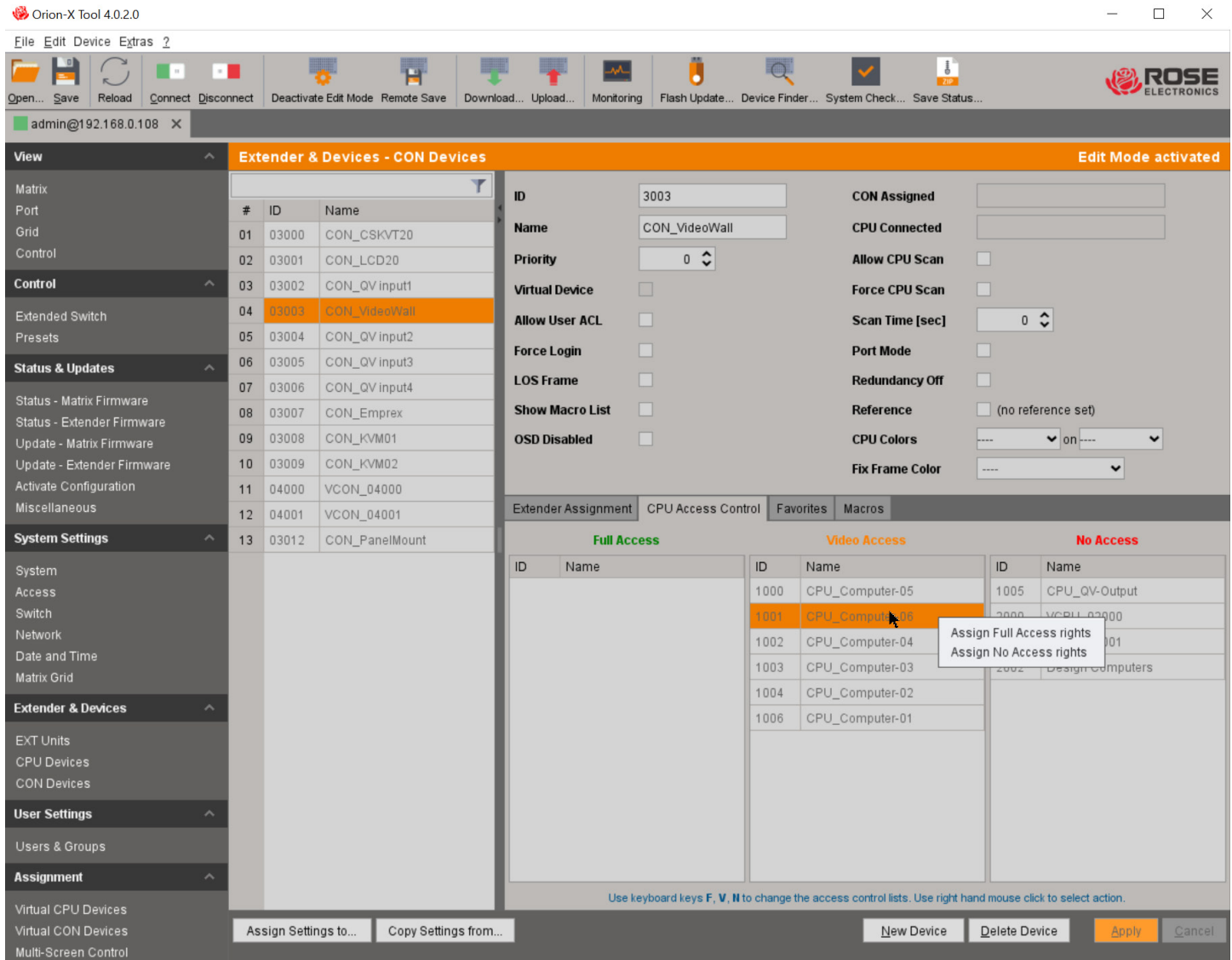

Figure 121. Assign CON Device Access Rights by Right Click

4. Confirm the configuration by clicking the **Apply** button.

The following keyboard commands can be used.

Function	Keyboard Command
Add CPU to list <b>Full Access</b>	<F>
Add CPU to list <b>Video Access</b>	<V>
Add CPU to list <b>No Access</b>	<N>

Table 50. Keyboard Commands for CPU Access Assignment in Java Tool in CON Devices Menu

## OSD Mouse and Keyboard Configuration

Console mouse and keyboard behavior in the OSD menus is configured in this menu. These settings can be set separately for each console. This menu can be accessed in the OSD and the Java Tool.

The following settings are available.

Field	Selection	Description
<b>Horizontal mouse speed [1/x]</b>	1 to 9	Adjustment of the horizontal mouse speed, 1 = slow, 9 = fast (default value: 4)
<b>Vertical mouse speed [1/x]</b>	1 to 9	Adjustment of the vertical mouse speed, 1 = slow, 9 = fast (default value: 5)
<b>Double click time [ms]</b>	100 to 800	Set the maximum time between 2 mouse clicks for them to be recognized as a double click (default value: 200 ms)
<b>Keyboard Layout</b>	Region	Set the keyboard layout used by the OSD to match that of the keyboard in use (English US, German, etc.).
<b>Video Mode</b>	Variable or specific resolution	Display resolution used for the OSD
<b>Hot Key</b>	Keystroke	Key that opens command mode
<b>Fast Key</b>	Keystroke	Single Key that displays the OSD

**Table 51. Mouse and Keyboard Settings**

**Note:** A console's Hot Key and Fast Key settings take precedence over Global Hot Key and Fast Key assignments.

## Modifying OSD Mouse and Keyboard Settings with the OSD

- Select **Configuration** in the main menu and log in.
- Select **EXT Units** in the **Configuration** menu.

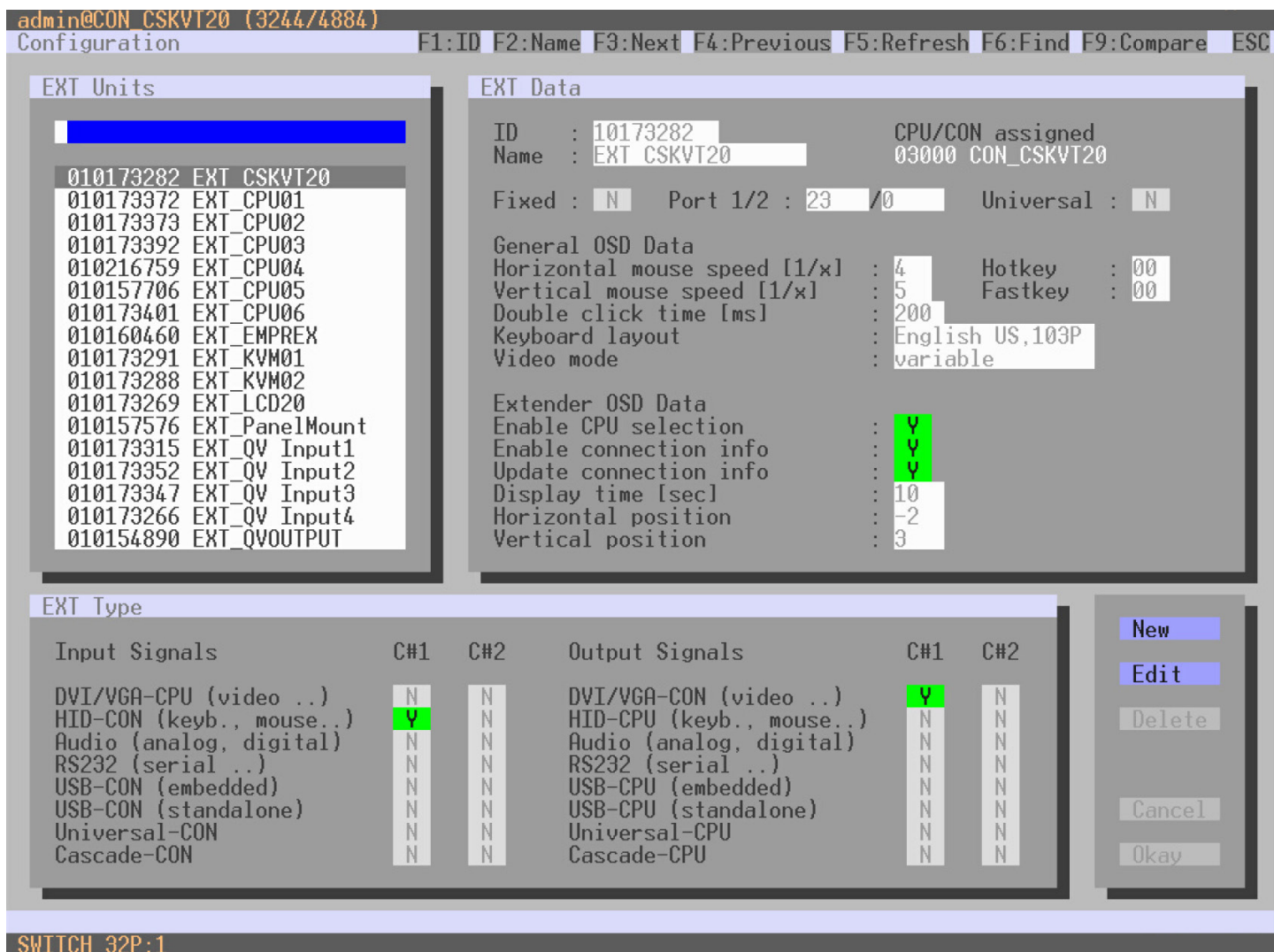

Figure 122. Modifying OSD Mouse and Keyboard Settings through the OSD

Select a Console extender and make the appropriate changes to the mouse and keyboard settings in the General OSD Data section. Then click one of the following buttons:

Button	Function
Cancel	Reject changes
Okay	Save changes

Table 52. Buttons in the Console Extender OSD Mouse and Keyboard Settings Screen

## Modifying OSD Mouse and Keyboard Settings through the Java Tool

➔ Select **Extender & Devices > EXT Units** in the task area.

The screenshot shows the Orion-X Tool 4.0.2.0 interface. The main window is titled "Extender & Devices - EXT Units" and is in "Edit Mode activated". The interface is divided into several sections:

- Left Panel:** A navigation tree with categories like "Control", "Status & Updates", "System Settings", "Extender & Devices", "User Settings", and "Assignment". The "Extender & Devices" category is expanded, showing "EXT Units", "CPU Devices", and "CON Devices".
- Table:** A table listing 18 EXT units. The selected unit is "EXT\_LCD20" (ID: 010173269, Port: 25, Type: CON).
- Right Panel:** Configuration details for the selected unit. It includes fields for ID, Name, Port, and Fixed. Below this is a "Location" section with a "Link 1" field containing device and board information. At the bottom of the right panel are tabs for "Extender Type", "Firmware Version", "General OSD Data", and "Extender OSD Data". The "General OSD Data" tab is active, showing settings for:
  - Horizontal Mouse Speed [1/x]: 4
  - Vertical Mouse Speed [1/x]: 5
  - Double Click Time [ms]: 200
  - Keyboard Layout: English (US, 103P)
  - Video Mode: Variable
  - Hot Key: Pre-configured Hot Key
  - Fast Key: Pre-configured Fast Key
- Bottom Panel:** Action buttons including "Assign Settings to...", "Copy Settings from...", "Restart Extender", "New Unit", "Delete Unit", "Apply", and "Cancel".

Figure 123. Modifying Mouse and Keyboard Settings through the Java Tool

1. Select an EXT unit with type CON.
2. Click the **General OSD Data** tab.
3. Make the appropriate changes to the mouse and keyboard settings.
4. Click the **Apply** button to save the changes.

## Console Extender OSD Settings

Console Extender OSD properties can be adjusted here. These local settings apply to individual consoles. The menu can be accessed from the OSD and the Java Tool. The following Extender OSD settings can be modified.

Field	Selection	Description
<b>Enable CPU Selection</b>	Y	When the key sequence to open the OSD is entered, a CPU selection list will be displayed in the center of the screen. Pressing <F7> while the selection list is on the screen displays the Main OSD menu.
	N	Function not active (default)
<b>Enable Connection Info</b>	Y	Enable extender connection info OSD (default)
	N	Function not active
<b>Update Connection Info</b>	Y	Update connection changes during fade-in of Extender OSD (default)
	N	Function not active
<b>Display Time [sec]</b>	0-999 seconds	Duration of OSD fade-in (default: 10)
<b>Horizontal Position [10 px]</b>	10 pixels	Horizontal position of the OSD (default: -2)
<b>Vertical Position [10 px]</b>	10 pixels	Vertical position of the OSD (default: 2)
<b>OSD Position Presets</b>	Selection	Preset locations for the connection information OSD on the Console display

Table 53. Extender OSD Settings

### Note:

- When setting the Connection Info OSD horizontal position, a prefixed minus describes the location with respect to the right edge of the monitor, e.g. -2 means 2 x 10 = 20 pixels of distance to this edge. When setting a vertical position, a prefixed minus describes the location with respect to the bottom edge of the monitor.
- If **Update Connection Info** is deactivated, the Extender OSD only appears when switching via OSD.

## Modifying Console Extender OSD Settings through the OSD

- ➔ Select **Configuration** in the main menu and log in.
- ➔ Select **EXT Units** in the **Configuration** menu.

The screenshot shows the Orion FX OSD Configuration menu. At the top, it displays the user 'admin@CON\_CSKVT20 (3244/4884)' and the 'Configuration' menu. Below this, there are three main sections:

- EXT Units:** A list of console extenders. The first entry, '010173282 EXT\_CSKVT20', is highlighted in blue.
- EXT Data:** Configuration options for the selected unit. It shows fields for ID (10173282), Name (EXT\_CSKVT20), CPU/CON assigned (03000 CON\_CSKVT20), Fixed (N), Port 1/2 (23/0), and Universal (N). It also includes 'General OSD Data' (Horizontal mouse speed, Vertical mouse speed, Double click time, Keyboard layout, Video mode) and 'Extender OSD Data' (Enable CPU selection, Enable connection info, Update connection info, Display time, Horizontal position, Vertical position).
- EXT Type:** A table defining input and output signals for various devices.

At the bottom left, the status 'SWITCH\_32P:1' is visible. On the right side, there are buttons for 'New', 'Edit', 'Delete', 'Cancel', and 'Okay'.

Input Signals	C#1	C#2	Output Signals	C#1	C#2
DVI/VGA-CPU (video ..)	N	N	DVI/VGA-CON (video ..)	Y	N
HID-CON (keyb., mouse..)	Y	N	HID-CPU (keyb., mouse..)	N	N
Audio (analog, digital)	N	N	Audio (analog, digital)	N	N
RS232 (serial ..)	N	N	RS232 (serial ..)	N	N
USB-CON (embedded)	N	N	USB-CPU (embedded)	N	N
USB-CON (standalone)	N	N	USB-CPU (standalone)	N	N
Universal-CON	N	N	Universal-CPU	N	N
Cascade-CON	N	N	Cascade-CPU	N	N

Figure 124. Modifying Extender OSD Settings through the OSD

To change the Extender OSD settings, proceed as follows:

1. Select the console extender in the **EXT Units** list for which OSD settings are to be modified.
2. Confirm the selection by pressing the <Enter> key, and the console's EXT Data will be enabled for editing.
3. Make the desired modifications to the Extender OSD Data settings.
4. Click the **Okay** button to confirm the changes.

## Modifying Console Extender OSD Settings through the Java Tool

➔ Select **Extender & Devices > EXT Units** in the task area.

The screenshot shows the Orion-X Tool 4.0.2.0 interface. The main window is titled 'Extender & Devices - EXT Units' and is in 'Edit Mode activated'. The interface is divided into several sections:

- Left Panel:** A navigation tree with categories like 'View', 'Control', 'Status & Updates', 'System Settings', 'Extender & Devices', 'User Settings', and 'Assignment'. The 'Extender & Devices' category is expanded to show 'EXT Units', 'CPU Devices', and 'CON Devices'.
- Table:** A table listing 18 units. The selected unit is 'EXT\_CSKVT20' (ID: 010173282, Port: 23, Type: CON).
- Right Panel:** A configuration panel for the selected unit. It includes fields for ID, Name, Port, Fixed, and Location. Below these are tabs for 'Extender Type', 'Firmware Version', 'General OSD Data', and 'Extender OSD Data'. The 'Extender OSD Data' tab is active, showing settings for 'Enable Connection Info', 'Update Connection Info', 'Enable CPU Selection', 'Display Time [sec]', 'Horizontal Position [10 px]', 'Vertical Position [10 px]', and 'OSD Position Presets'. A preview window shows 'Example P EXT OSD 920 x 1080'.
- Bottom Panel:** A row of buttons: 'Assign Settings to...', 'Copy Settings from...', 'Restart Extender', 'New Unit', 'Delete Unit', 'Apply', and 'Cancel'.

Figure 125. Modifying Extender OSD Settings through the Java Tool

In order to change the Extender OSD settings, proceed as follows:

1. Select the console extender in the **EXT Units** list for which Extender OSD settings are to be modified.
2. Click the **Extender OSD Data** tab.
3. Modify the desired settings and confirm by clicking the **Apply** button.

## Console Favorites List

Lists of up to 32 favorite CPUs can be created for each console. Switching to a CPU in the console favorites list is done by pressing the keyboard 'Hot Key' sequence followed by the number of the CPU in the list (1 to 16). This menu can be accessed in the OSD and the Java Tool.

### Setting up Console Favorites through the OSD

- Select **Assignments** in the main menu.
- Select **CON Favorites**.

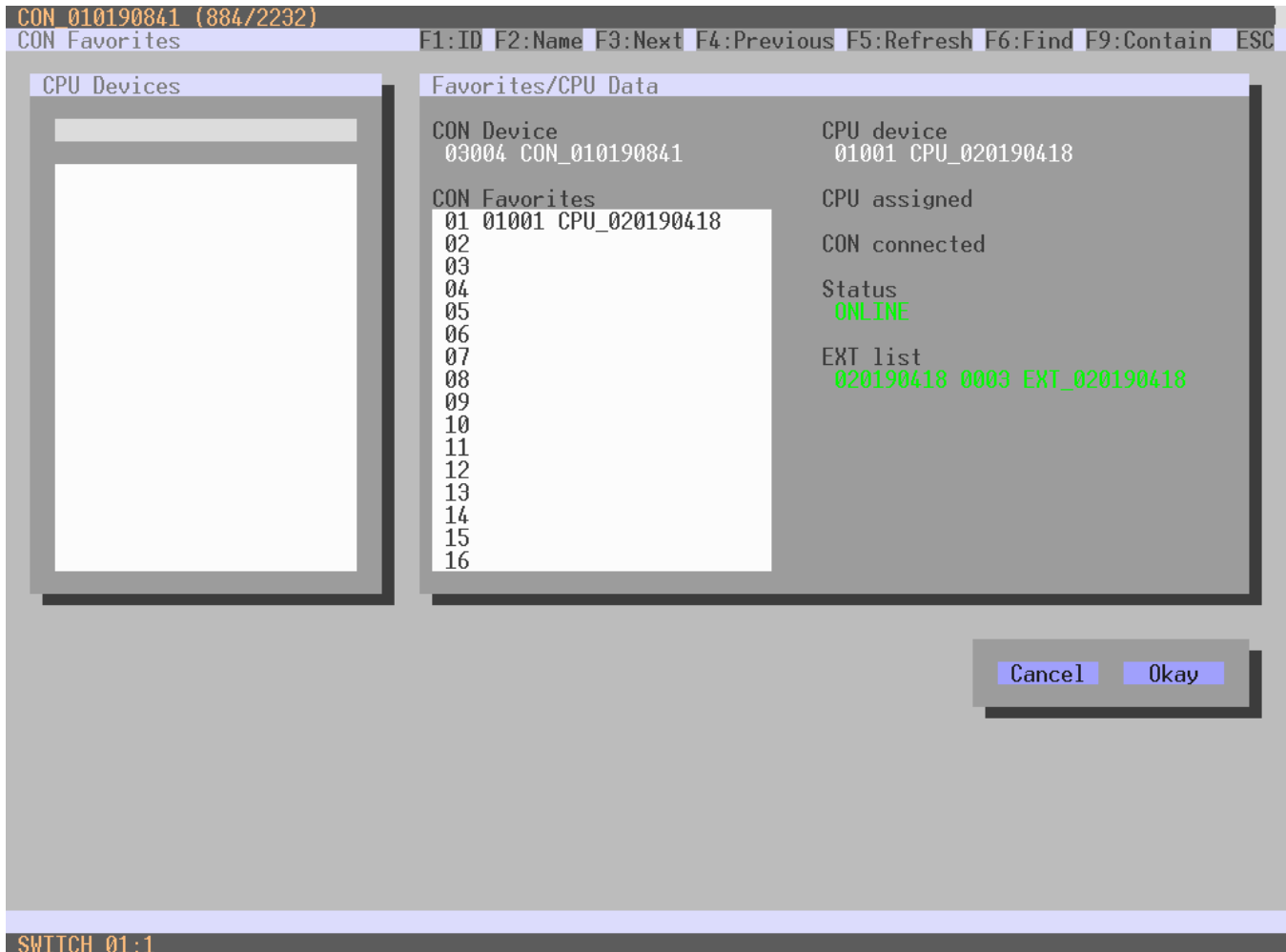

Figure 126. Setting up Console Favorites through the OSD

To create a list of favorites for the *console in use*, proceed as follows:

1. Select a CPU from the **CPU Devices** list. Press the keyboard <a> key to move the selected CPU device to the CON favorites list. Press the <r> key to remove a selected CPU from the favorites list. Repeat the process to add more CPUs to the favorites list.
2. The position of the CPU devices within the favorites list can be changed by selecting a CPU and pressing the <+> and <-> keys.
3. Click the **Okay** button to save the settings.

## Setting up Console Favorites with the Java Tool

➔ Select **Extender & Devices > CON Devices** in the Task area, then select a console in the **CON Devices** list and click the **Favorites** tab to open it.

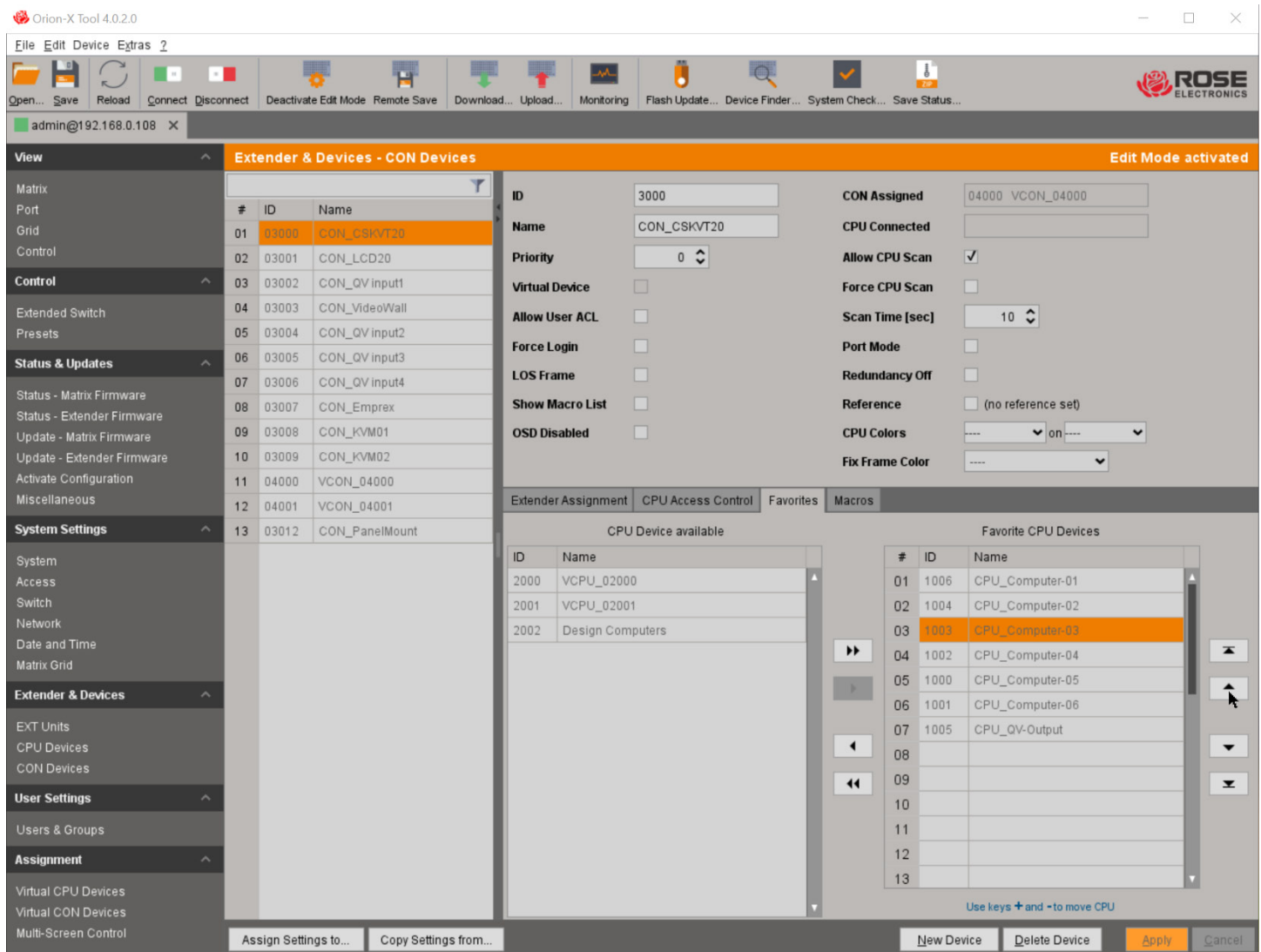

Figure 127. Setting Up Console Favorites through the Java Tool

To create a favorites list for *any console*, proceed as follows:

1. Select CPU devices in the **CPU Device available** list to be added to the console favorites list (**Favorite CPU Devices**). Press and hold the <Ctrl> key to select more than one CPU device at a time.
2. Click the ► button to move the selected CPU devices to the favorites list. If the ►► button is pressed, the first 32 CPU devices in the **CPU Device available** list will be moved to the favorites list.
3. The position of a selected CPU device within the favorites list can be changed by pressing the <+> and <-> keypad keys to move the selected CPU up or down in the list, or alternatively by clicking the up and down arrows to the right of the favorites list.
4. To remove selected CPU devices from the favorites list, press the ◀ button. If the ◀◀ button is pressed, all CPU devices will be removed from the console favorites list.
5. Click the **Apply** button to save the list.

## Console Macros

This menu is used to create console macro commands for switching, disconnecting or user administration. Console macro commands are created for each console separately. A single macro can execute up to 16 successive switching commands. Console macros are invoked by typing the keyboard 'Hot Key' sequence, followed by the function key assigned to the macro, <F1>-<F16>. It can be accessed in the OSD and the Java Tool. The following functions can be used in console macros. The Macros can also be used to switch to CPU groups.

Field	Selection	Description
<b>Function (01-16)</b>	<b>Connect (P1=CON, P2=CPU)</b>	Make a full keyboard, mouse, and video connection from console P1 to CPU P2
	<b>Connect Video (P1=CON, P2= CPU)</b>	Make a video connection from console P1 to CPU P2
	<b>Disconnect (P1=CON)</b>	Disconnect console P1
	<b>Logout User</b>	Logout current user
	<b>Assign CPU (P1=VCPU, P2=RCPU)</b>	Assign a virtual CPU device to a real CPU device (see Virtual CPU)
	<b>Assign CON (P1=RCON, P2=VCON)</b>	Assign a real CON device to a virtual CON device (see Virtual Console)
	<b>Push (P1=CON)</b>	The console's current full KVM connection is forwarded to console P1 and the console's connection is changed to video only.
	<b>Push Video (P1=CON)</b>	The video signal of the console's current connection (KVM or video only) is forwarded to console P1. The console's connection remains unchanged (KVM or video only).
	<b>Get (P1=CON)</b>	The console gets a KVM connection to the CPU that is currently connected to console P1. The connection of console P1 is changed to a video only connection.
	<b>Get Video (P1=CON)</b>	The console gets a video only connection to the CPU that is currently connected to console P1. The connection of console P1 remains unchanged (KVM or video only).
	<b>Login User (P1= User, P2= CON)</b>	Login User P1 at console P2

Table 54. Console Macro Settings

## Setting up Console Macros through the OSD

- Select **Configuration** in the main menu and log in.
- Select **CON Macros**.

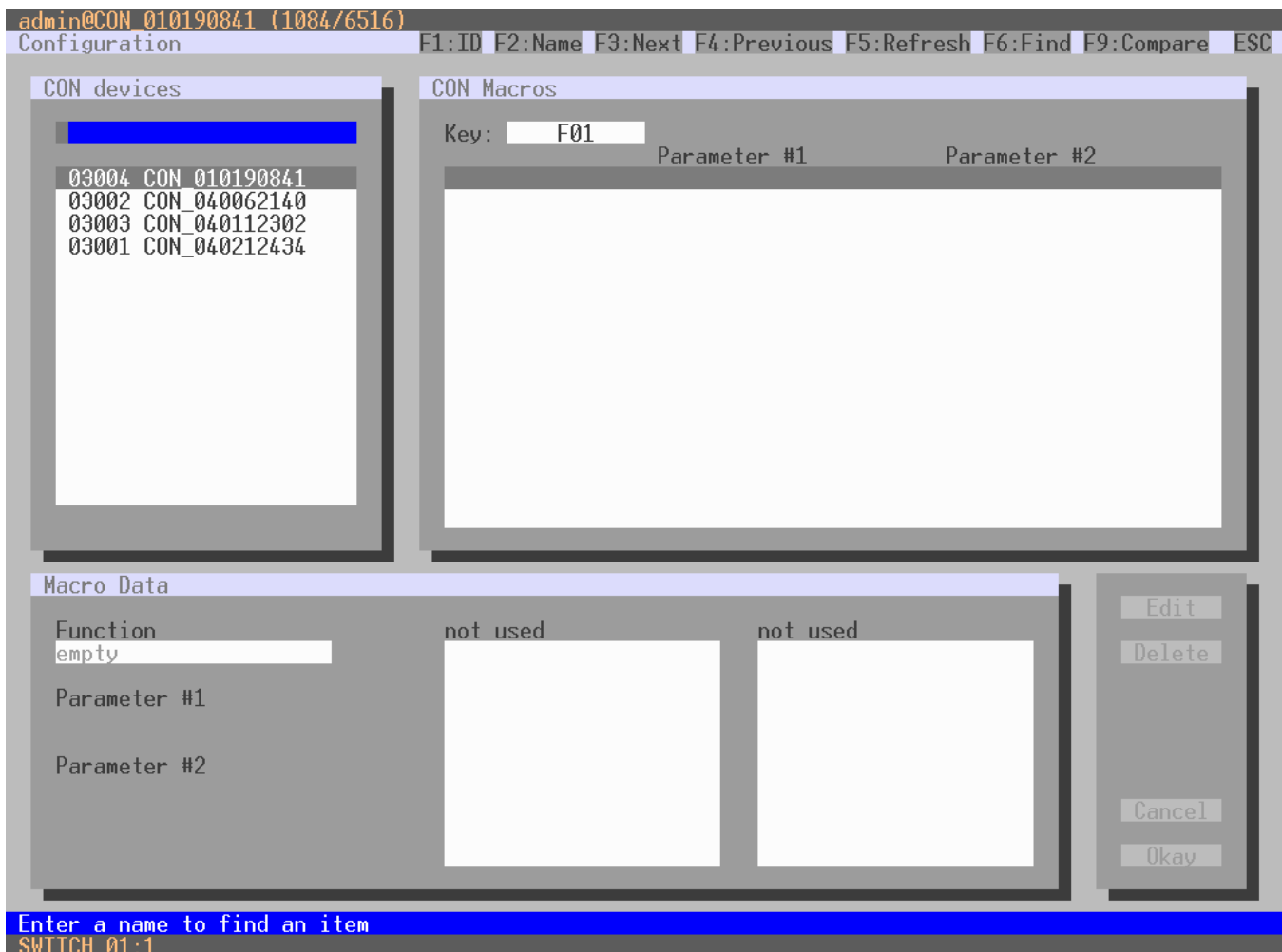

Figure 128. Setting Up Console Macros through the OSD

To create a macro for a console, proceed as follows:

1. Select a console in the **CON devices** list.
2. Select a keyboard function key (F1 to F16, or Shift-F1 to Shift-F16) in the **Key** field to be used with the hot key sequence to invoke the macro.
3. Select the position in the macro list (1-16) where the macro command is to be inserted.
4. Click the **Edit** button to activate the **Function** field, and select the desired function by pressing the keyboard up or down arrow keys.
5. Press the Tab key to select the appropriate parameters **P1** and **P2** (e.g. CON Devices or CPU Devices) for the selected macro command.
6. Pressing the keyboard <Enter> key will confirm the current command and add it to the macro list. Repeat the process to add additional commands to the macro as necessary.

## Setting up Console Macros through the Java Tool

➔ Select **Extender & Devices > CON Devices** in the Task area, then select a console in the **CON Devices** list and click the **Macros** tab.

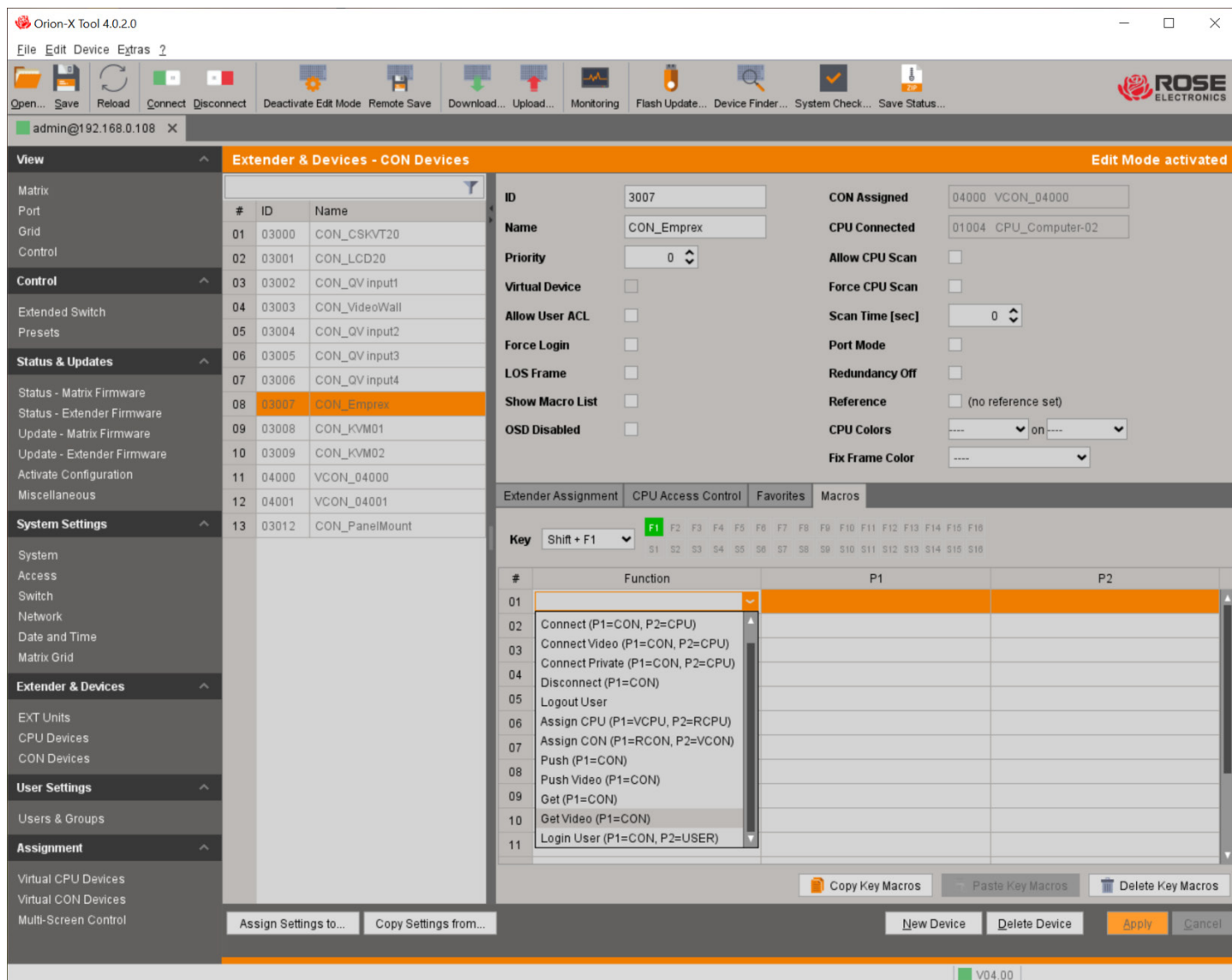

Figure 129. Setting up Console Macros through the Java Tool

To create a macro for the selected console, proceed as follows:

1. Select a keyboard function key (F1 to F16, and Shift + F1 to F16) in the **Key** field to be used to invoke the macro.
2. In the Function column, select the action that should be part of the macro. The selection list is opened by a double click on an empty field.
3. Select in the **P1** and **P2** columns the appropriate parameters for the macro function (e.g. consoles and CPUs).
4. Confirm the inputs by clicking the **Apply** button.

For convenient macro configuration, the following context functions are available:

To assign a console's macros to other consoles:

1. Click on the console, then click the **Assign Settings to...** button (located below the CON devices list).

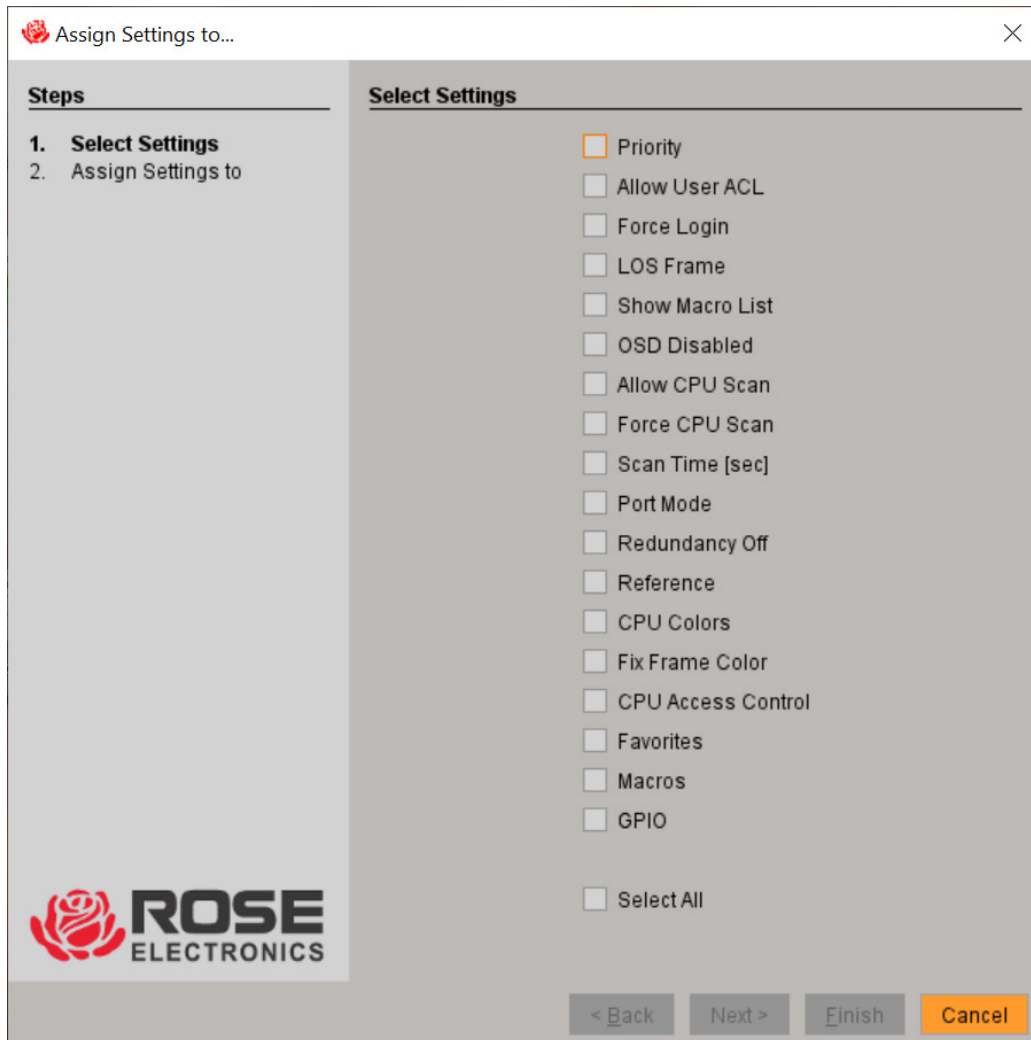

Figure 130. Assign Settings Menu in the Java Tool

2. Select **Macros** from the pop-up list of settings, and then click **Next**.

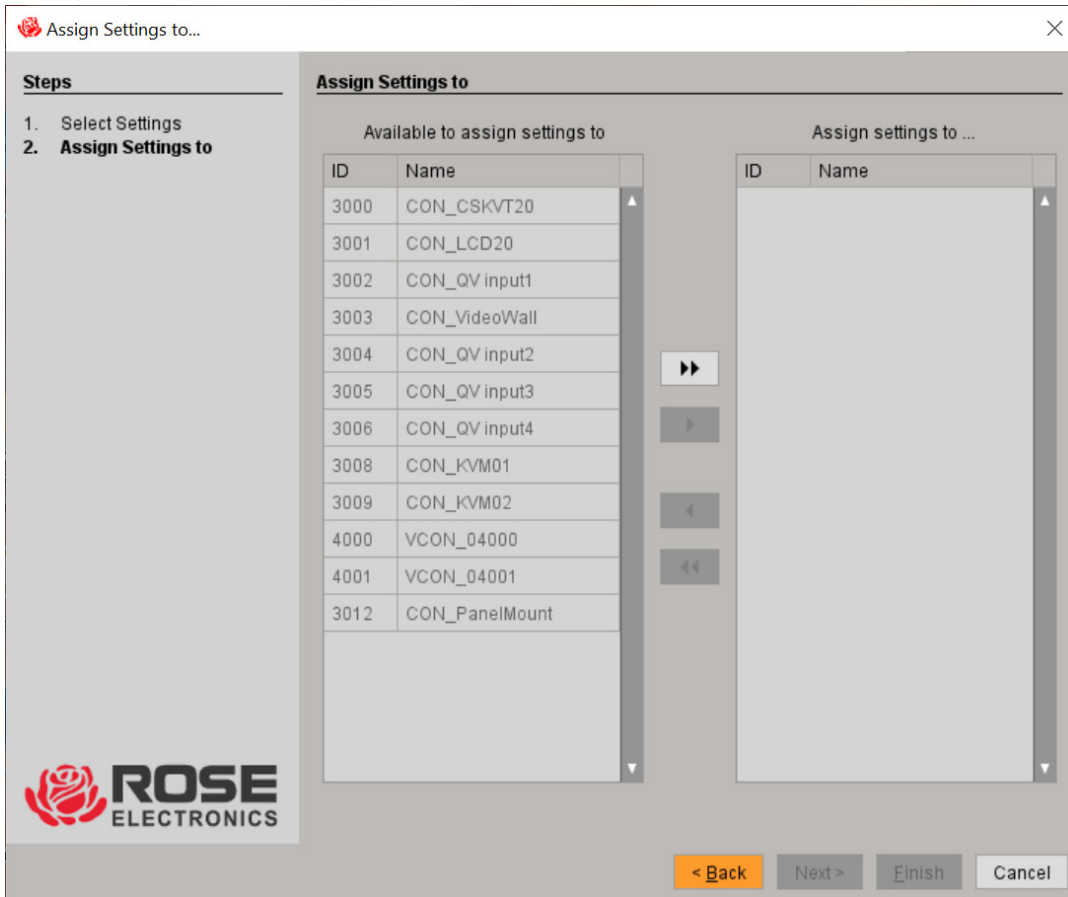

Figure 131. Select CON Device to Receive Assigned Settings in the Java Tool

3. Select the consoles to receive the macros from the list of available consoles and click the ► button to add those consoles to the **Assign settings to...** list.
4. Click **Finish** to complete the macro assignments.

The **Copy Settings from...** button functions similarly, except the console to receive macros is selected first.

All the macro commands of a selected key can be copied into the cache by clicking the **Copy Key Macros** icon located below the P1 column. These macros can then be pasted into a different key by selecting the key and clicking the **Paste Key Macros** icon. All macros of a selected key can be removed by clicking the **Delete Key Macros** icon.

## Virtual Console

Orion FX allows assigning real consoles to virtual consoles. The process of setting and changing access permissions can be simplified by changing the permissions of a virtual console, and then applying them to all real consoles assigned to the virtual console. Virtual consoles can be switched in exactly the same way as real consoles. If a virtual console is switched to a CPU, all real consoles assigned to the virtual console will receive the video signal. The last real console assigned to a virtual console will also have keyboard and mouse control.

This menu is available in the OSD and the Java Tool.

### Assignment of Virtual Consoles through the OSD

→ Select **Assignments > Virtual CON devices** in the main menu.

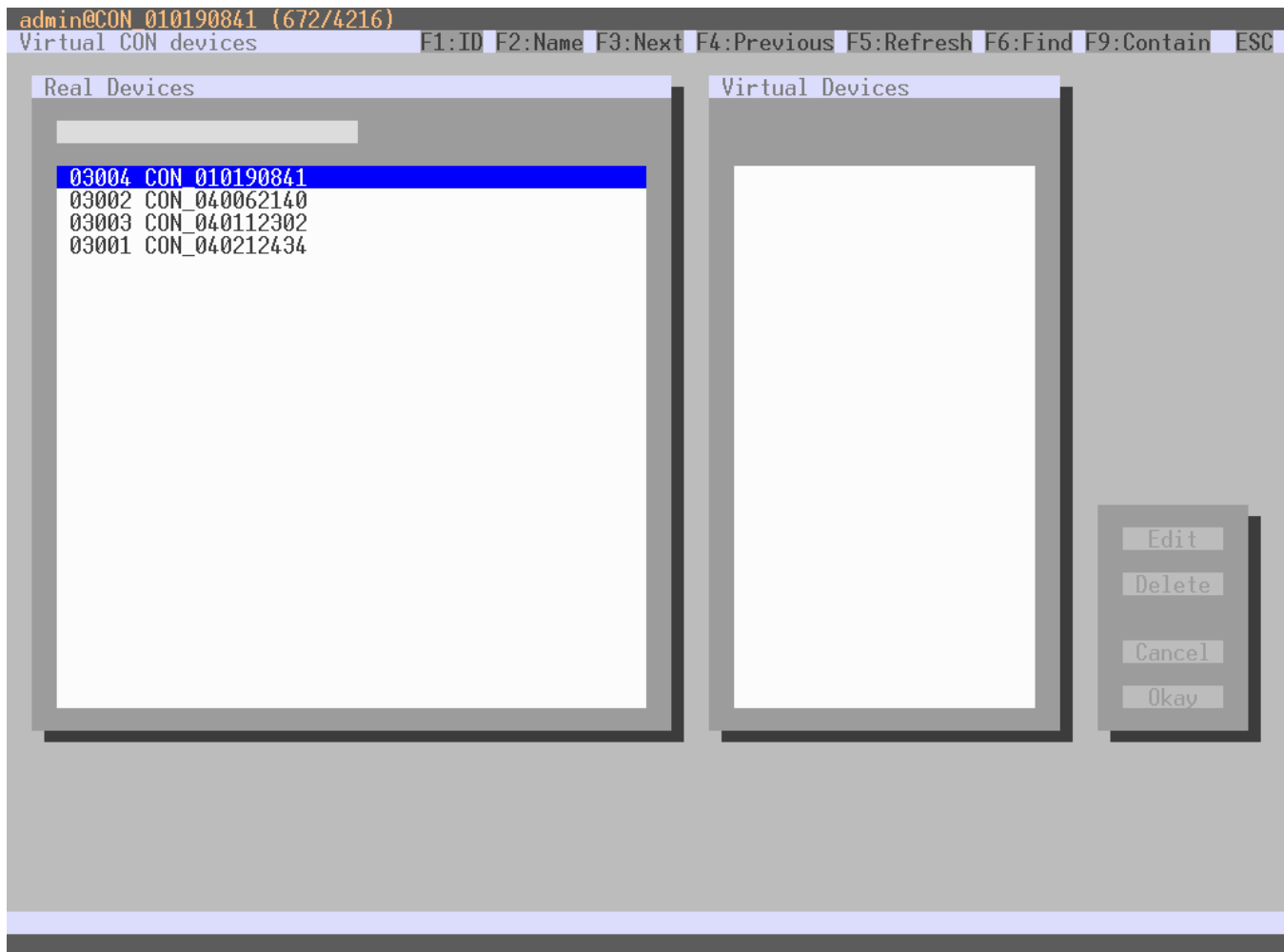

Figure 132. Virtual CON Devices Assignment through the OSD

To make an assignment, proceed as follows:

1. Select the real console in the **Real Devices** list that is to be assigned to a virtual console.
2. Click the **Edit** button.
3. Select the virtual console in the **Virtual Devices** list that is to be assigned to the selected real console.
4. Click the **Okay** button to confirm the assignment.

A virtual console can be assigned to more than one real console.

## Assignment of Virtual Consoles through Java Tool

➔ Select **Assignment > Virtual CON Devices** in the task area.

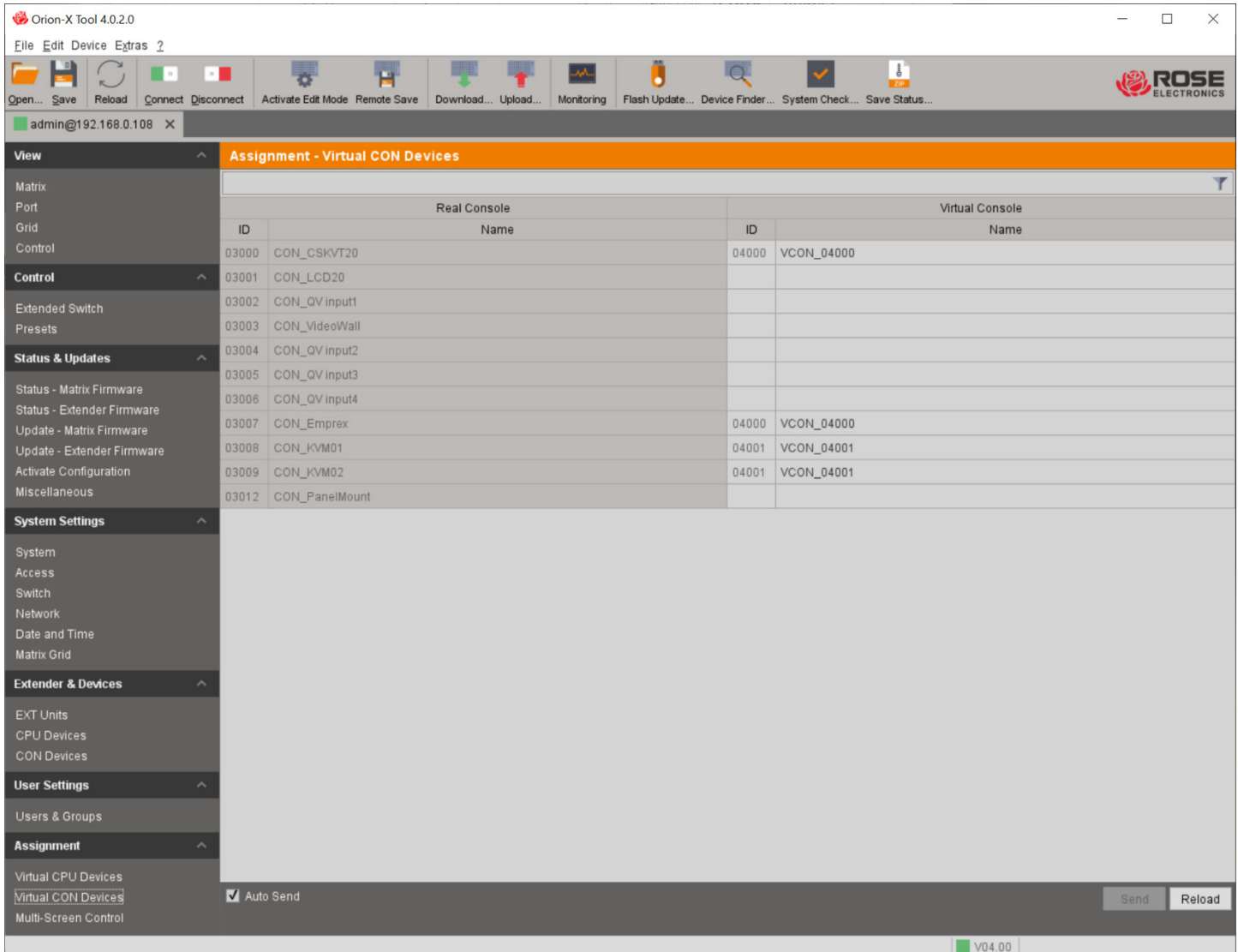

Figure 133. Virtual to Real Console Assignment through Java Tool

To make an assignment, proceed as follows:

1. Select the desired real console in the **Real Console** table.
2. Double click in the **Virtual Console** column to get a list of all available virtual consoles.
3. Select the desired virtual console.

Select between the following buttons:

Button	Function
<b>Send</b>	Send assignments to the matrix
<b>Reload</b>	Reload changes

Table 55. Java Tool Virtual CON Assignment Screen Buttons

When the **Auto Send** function in the left lower corner of the working area is ticked, switching operations will be done immediately without confirmation by pressing the **Send** button.

There is a blank field just above the Real Console and Virtual Console, which can be used to enter characters to filter long lists of devices. Only those consoles whose names or ID numbers match the entered characters are displayed.

### *Shared Operation*

This menu enables shared operation of a CPU Device by two or more CON Devices. A CPU Device can be controlled by only one CON Device at a time but control can be taken over by other CON Devices. Control of a CPU Unit by a CON Unit is relinquished after the expiration of an inactivity timer associated with the controlling CON Device. The mouse or keyboard may also be used to take control.

In order to allow a smooth and accurate function of the shared operation, you should use identical mice and keyboards. They should be connected to the same USB-HID ports of each CON Unit.

If the Release Time value is set to less than 10 seconds, and if control transfer takes place in less than 10 seconds, any assigned USB 2.0 / 3.0 extenders will not be switched due to security and stability considerations. Shared operation will be not be active between CON Devices with a different priority.

The Shared Operation menu can be accessed in the OSD and the Java Tool.

## Setting up Shared Operation with the OSD

- Select **Configuration** in the main menu and log in.
- Select **Switch**.

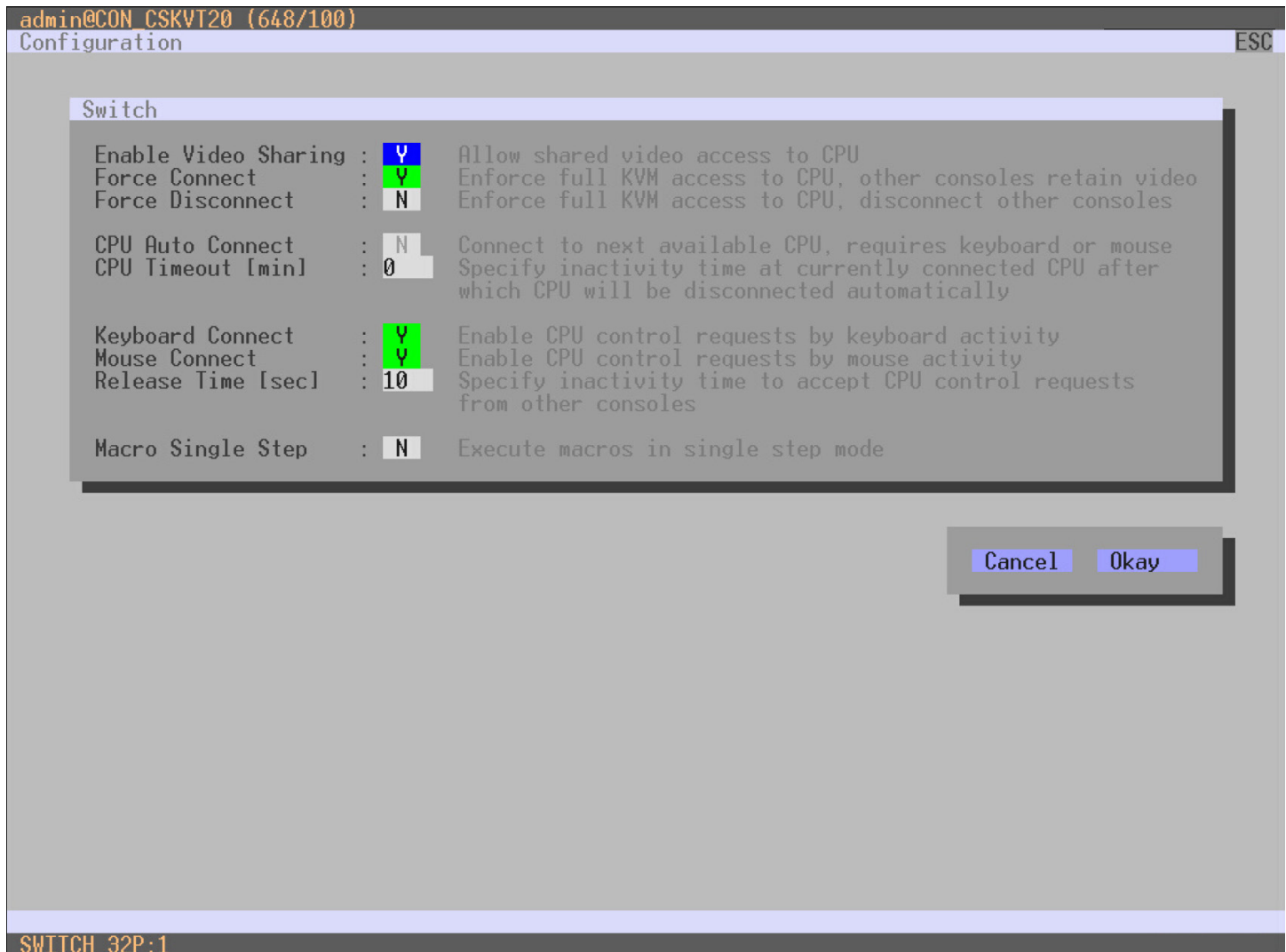

Figure 134. Enabling Shared Operation with the OSD

1. Activate the **Enable Video Sharing** function.
2. Activate the **Force Connect** function.
3. Activate the **Keyboard Connect** function, if taking over control by a keyboard event should be possible.
4. Activate the **Mouse Connect** function, if taking over control by a mouse movement should be possible.
5. Define a **Release Time** of inactivity (0 - 999 sec.) after which control can be taken over.

## Setting up Shared Operation with the Java Tool

➔ Select **System Settings > Switch** in the task area.

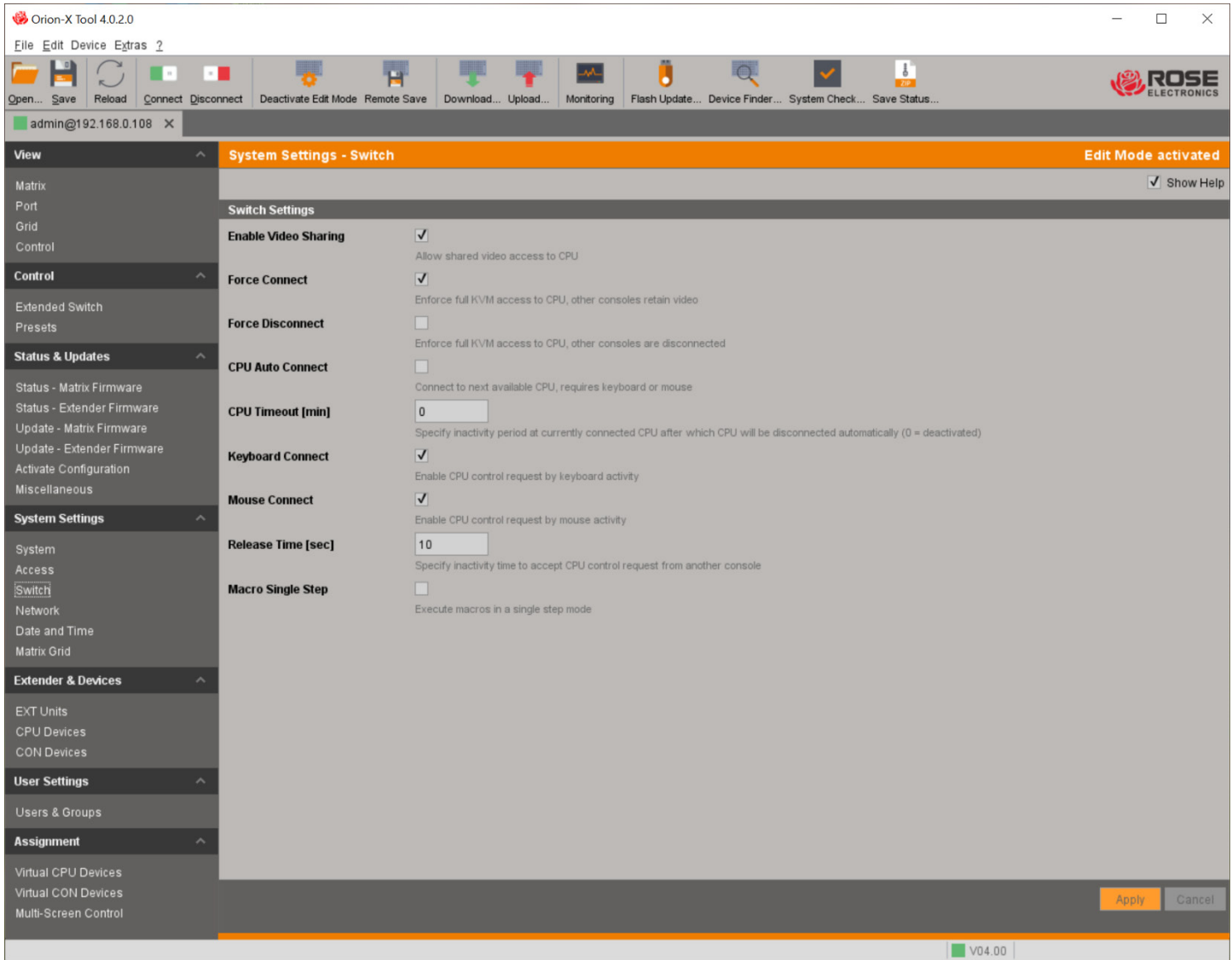

Figure 135. Enabling Shared Operation with the Java Tool

1. Activate the **Enable Video Sharing** function.
2. Activate the **Force Connect** function.
3. Activate the **Keyboard Connect** function, if taking over control by a keyboard event should be possible.
4. Activate the **Mouse Connect** function, if taking over control by a mouse movement should be possible.
5. Define a **Release Time** of inactivity (0 - 999 sec.) after which control can be taken over.
6. Click the **Apply** button to confirm the changes.

## Multi-Screen Control

Multi-screen control allows a CON device to switch between up to eight computer sources using a single connected mouse and/or keyboard. The CON device can consist of up to eight CON units (eight monitors), or up to sixteen monitors when using Dual-head extender modules. The Extender Units assigned to the multi-display CON Device must be physically connected to the same block of eight ports on a matrix I/O board.

**Note:** When configuring Multi-Screen Control via OSD, the number of supported monitors is limited to four. For this reason, it is recommended to configure Multi-Screen control with the Java Tool software.

Typically, one of the CON Devices in the multi-screen group is designated “Control CON Device”, which means it has USB-HID keyboard and mouse control of the connected sources. The Control Device performs smooth switching between sources with the mouse by dragging the mouse pointer beyond the edge of the currently active display. The displays can be arranged side by side, in a grid layout, or completely freely. Switching can also be performed by Control Device keyboard commands.

**Note:** Sources to be used in a Multi-Screen configuration should support absolute mouse mode.

When using multi-head sources (e.g. dual-head), the necessary extended configuration must be set up with the Java Tool. Multi-Head configuration for Apple Mac sources is not supported.

CON Units that have been already configured for Multi-Screen Control can be connected together to other blocks of up to 8 ports. In this case, any further configuration is not necessary; their functionality will remain as set previously.

If a CON Unit with the ability to connect a local source (computer, CPU) is configured for Multi-Screen control, switching to the local source will be disabled.

### Configuring Multi-Screen Control through the OSD (for Single-Head Applications)

The following parameters can be configured through the OSD menu:

Field	Selection	Description
<b>Enabled</b>	Y	Activate the display for multi-screen control
	N	Function not active (default)
<b>Control</b>	Y	Enable the CON device to have USB-HID control of other CON devices in the Multi-Screen group
	N	Function not active
<b>Owner</b>	Selection	<ul style="list-style-type: none"><li>• Shared (default) permits a Control device’s keyboard and mouse to access this device.</li><li>• The device’s own name instead of Shared restricts access by other devices in the group.</li></ul>
<b>Frame</b>	0-999 seconds	Time to fade-in a red frame on the display currently controlled by keyboard and mouse

**Table 56. Multi-Screen Parameters in the OSD**

To configure Multi-Screen Control using the OSD, proceed as follows:

1. Open the OSD of a CON unit connected to an I/O board where the connected CON units are to be configured for Multi-Screen Control. Choose the CON unit which will be used as the Control Device.
2. Select **Assignments > Multi-Screen Control** in the main menu and log in. Only the CON EXT units connected to the selected I/O board will be visible.

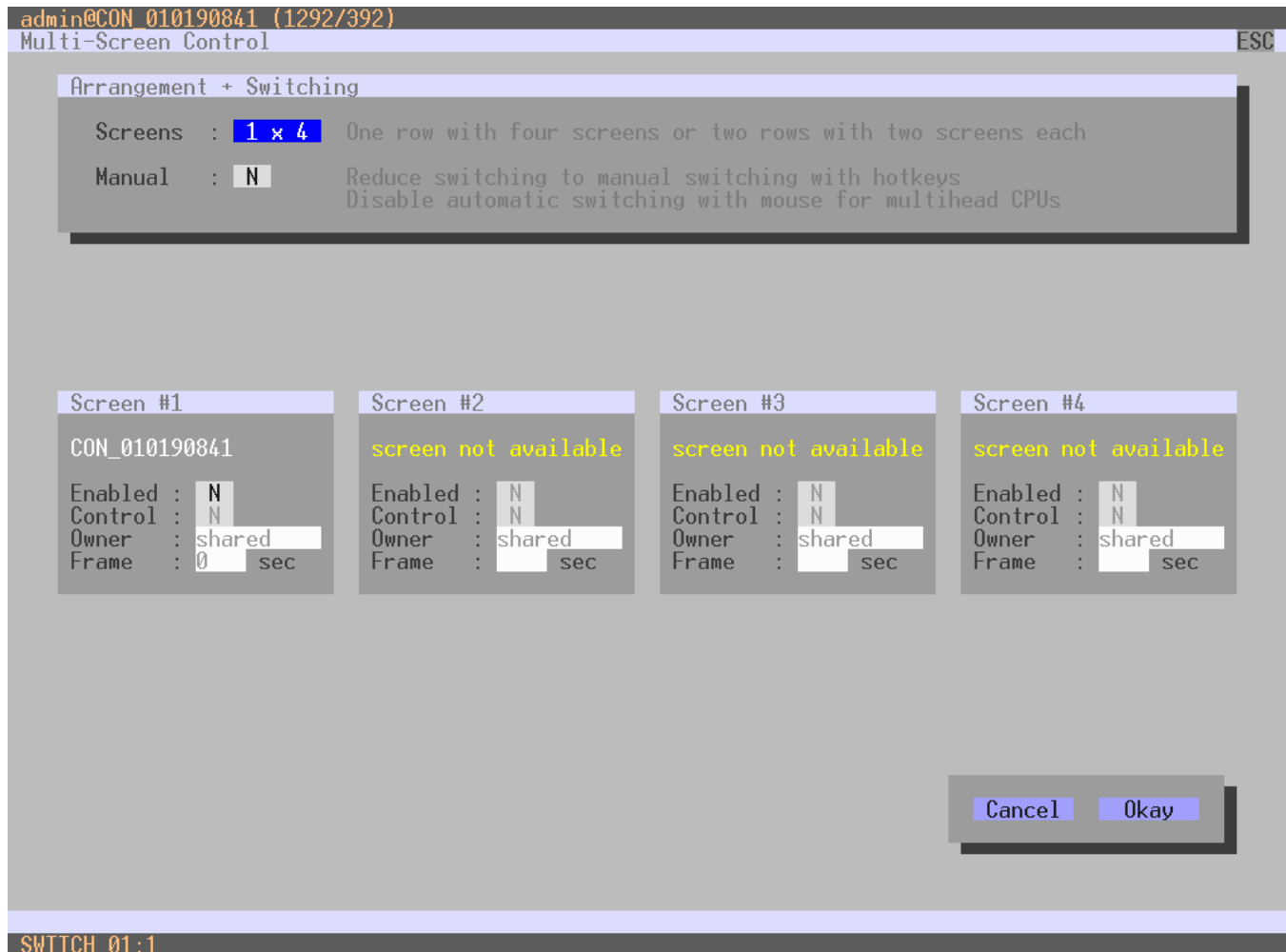

Figure 136. Setting Up Multi-Screen Control with the OSD

3. In the Arrangement field, select layout for the CON Device, 1 x 4 or 2 x 2. The fields for the configuration of the individual displays will be arranged accordingly.
4. Activate the **Manual** option if USB-HID switching is to be restricted to keyboard commands. For more information, see Operations section, [Multi-Screen Control](#).
5. Ensure that the **Enabled** option is set to **Y** on all displays to be included in Multi-Screen Control.
6. Set the **Control** function to **Y** on one or more CON devices to be enabled as Control CON device. These extender units have the ability to control the connected computers.
7. The **Owner** function is used to designate a control display whose keyboard and mouse will be used to switch between the sources. By default, the function is shared between the Control displays. To restrict the **Owner** function to a single Control display, click the **Owner** field and select the name of the desired Control CON Device.
8. Use the **Frame** function to configure a red frame that shows the video on the current display with mouse control after the expiration of a selectable timer. The frame to fade in can be individually activated by using a timer value greater than 0 seconds.

### Access Restriction when using Multiple Control CON Devices

Switching by dragging the mouse pointer past the edge of a display is only permitted with those CON devices that are enabled for access by a Control Device of the Multi-Screen group. To enable access to a display by a single Control CON Device, proceed as follows:

1. Click the Owner field of a Control CON Device and select the name of that Control CON Device from the list.
2. Click the Owner field of the other CON Devices and select the name of the Control CON Device.

Access to the other Con devices is now limited to the selected Control Device.

### No simultaneous USB HID sharing by multiple Control CON devices

When more than one CON unit in a Multi-Screen group is designated a Control device, there is no simultaneous sharing of other devices in the group. For example: In a Multi-Screen setup of 4 CON Devices, Devices 1 and 2 are each designated Control CON Devices. Both Devices 3 and 4 are configured **Owner = Sharing**. Devices 1 and 2 can access the displays of Devices 3 and 4, but they cannot have keyboard and mouse control of the same device at the same time. The keyboard and mouse of the Control CON Device that first had USB-HID control will be returned to its "own" display when the second Control CON Device takes over.

### Changing Multi-Screen Control

To modify the Multi-Screen setup of a specific I/O board, proceed as follows:

1. Open the OSD of a Control CON Device on the I/O board.
2. Select **Assignments > Multi-Screen Control** in the main menu. Only the CON EXT Units connected to the selected I/O board are visible.
3. Make any required edits of the Multi-Screen configuration.
4. Click the **Okay** button to confirm the changes.

### Deleting Multi-Screen Control

To delete the Multi-Screen Control for a setup of a specific I/O board, proceed as follows:

1. Open the OSD of a Control CON Device of the specific I/O board.
2. Select **Assignments > Multi-Screen Control** in the main menu. Only the CON EXT Units connected to the selected I/O board are visible.
3. Set the **Enable** option to **N** on all CON Devices.
4. Click the **Okay** button to confirm the changes. Multi-Screen Control is disabled for all CON Devices on the I/O board.

## Configuring Multi-Screen Control with the Java Tool

The following parameters can be configured with the Java Tool software:

Field	Selection	Description
<b>Dual-Head Extender</b>	Y	Enable configuration of 2 displays for this Dual-Head extender
	N	Function not active (default)
<b>Enabled</b>	Y	Activate the display for multi-screen control
	N	Function not active (default)
<b>Control</b>	Y	Enable the CON device to have USB-HID control of other CON devices in the Multi-Screen group
	N	Function not active
<b>Owner</b>	Selection	<ul style="list-style-type: none"> <li>Shared (default) permits a Control device's keyboard and mouse to access this device.</li> <li>The device's own name instead of Shared restricts access by other devices in the group.</li> </ul>
<b>Frame</b>	0-999 seconds	Set the keyboard/mouse inactivity timer after which a red frame is faded in at the display with current mouse/keyboard control. This frame remains active for a fixed period of time and disappears thereafter.

Table 57. Setting Up Multi-Screen Control with the Java Tool

To configure Multi-Screen Control using the Java Tool software, proceed as follows:

➔ Select **Assignment > Multi-Screen Control** in the task area.

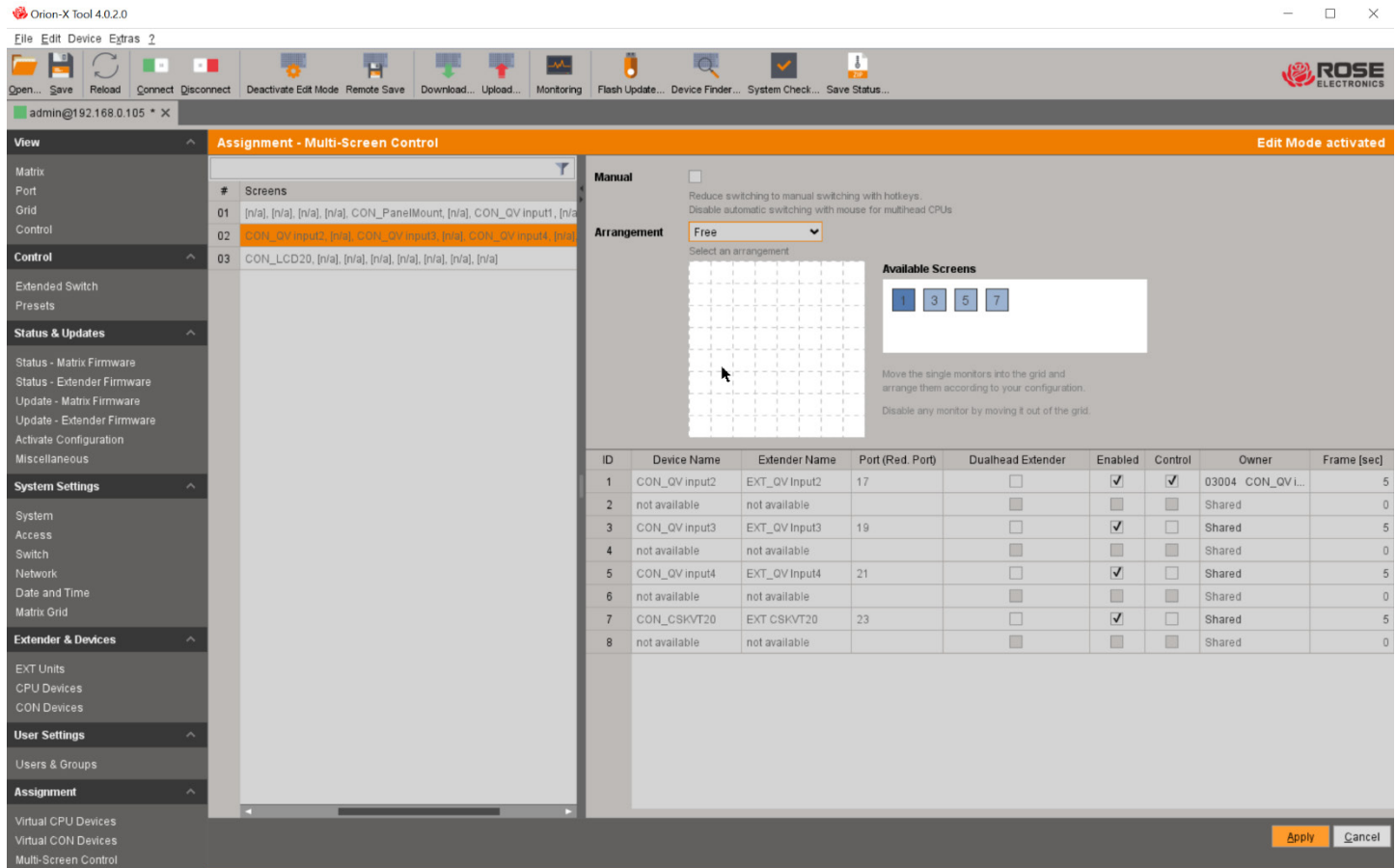

Figure 137. Setting Up Multi-Screen Control with the Java Tool

1. Select the block of four or eight ports in the working area list that are to be configured for Multi-Screen Control. Only blocks of four or eight ports that contain at least one CON Unit are shown.
2. Activate the **Manual** option if USB-HID switching should be restricted to keyboard commands. Manual switching allows the use of multi-head consoles. For more information, see Operations section, [Multi-Screen Control](#).
3. Select the desired layout for the CON Devices being configured in the **Arrangement** field.
  - **Horizontal**: for a maximum of four CON units
  - **Block**: for a maximum of four CON units
  - **Free**: for a maximum of eight CON units. Free allows flexible positioning of displays. To configure more than four CON Devices for Multi-Screen Control, the free layout must be used. Selecting **Free** will cause an **Available Screens** field to be displayed. Move the displays icons to the **Arrangement** field and position them as desired.
4. If a CON unit should be configured as a Dual-Head extender, click the **Dual-Head Extender** checkbox to activate the option.
5. Click the **Enable** checkbox of each CON Device to activate it in the Multi-Screen configuration.
6. Select one or more control displays within the CON Devices by clicking its **Control** checkbox function. These extenders have a keyboard and mouse connected, and have the ability to control the Multi-Screen setup by switching the keyboard and mouse from one CON unit to the next.
7. The **Owner** function is used to designate whether a CON unit can be accessed by a Control Device. To make a CON Unit's display accessible to control displays in the group, set the **Owner** function to **shared**. To prevent access to the CON device by Control devices, select the unit's name instead of **shared**.
8. Use the **Frame** function to configure a red frame that shows the current display with mouse control after the expiration of a selectable timer. The frame can be individually activated by using a timer value greater than 0 seconds.
9. Click the **Apply** button to confirm the Multi-Screen Control group.

#### **Access Restriction when using Multiple Control CON Devices**

Switching by dragging the mouse pointer past the edge of a display is only permitted with those CON devices that are enabled for access by a Control Device of the Multi-Screen group. To enable access to a display for a single Control CON Device, proceed as follows:

1. Click the Owner field of a Control CON Device and select the name of that Control CON Device from the list.
2. Click the Owner field of the other CON Devices and select the name of the Control CON Device from step 1.

The selected Control Device's mouse can now be used to access the other displays.

#### **No simultaneous USB HID sharing by multiple Control CON devices**

When more than one CON unit in a Multi-Screen group is designated a Control device, there is no simultaneous sharing of other devices in the group. For example: In a Multi-Screen setup of 4 CON Devices, Devices 1 and 2 are each designated Control CON Devices. Both Devices 3 and 4 are configured **Owner = Sharing**. Devices 1 and 2 can access the displays of Devices 3 and 4, but they cannot have keyboard and mouse control of the same device at the same time. The keyboard and mouse of the Control CON Device that first had USB-HID control will be returned to its "own" display when the second Control CON Device takes over.

### Changing Multi-Screen Control

Changes to Multi-Screen Control configuration are permitted only if the keyboard and mouse of the Control Device are switched to the Control Device's own display. To modify the Multi-Screen setup of a specific I/O board, proceed as follows:

1. Switch keyboard and mouse control to the Control CON Device.
2. Select **Assignments > Multi-Screen Control** in the main menu, and click the **Activate Edit Mode** menu item in the toolbar.
3. Select the Multi-Screen Control group to be modified in the Screens field of the Working area.
4. Make any required edits to the Multi-Screen configuration.
5. Click the **Apply** button to confirm the changes.

### Deleting Multi-Screen Control

Changes to Multi-Screen Control configuration are permitted only if the keyboard and mouse of the Control Device are switched to the Control Device's own display. To delete the Multi-Screen Control for a setup of a specific I/O board, proceed as follows:

1. Switch keyboard and mouse control to the Control CON Device.
2. Select **Assignments > Multi-Screen Control** in the main menu, and click the **Activate Edit Mode** menu item in the toolbar.
3. Select the Multi-Screen Control group to be modified in the Screens field of the Working area.
4. Click the **Enable** checkboxes of all the CON devices in the group to remove the checkmarks.
5. Click the **Control** checkbox of any unit designated as a Control CON Device to remove the checkmark.
6. Click the **Apply** button to confirm the changes. Multi-Screen Control is disabled for all CON Devices in the grouping.

## Extended Configuration for Multi-Head Multi-Screen Control with the Java Tool

For the use of Multi-Head computer sources in Multi-Screen applications, an additional configuration of the CPU Devices is required.

→ Select **Extender & Devices > CPU Devices** in the task area.

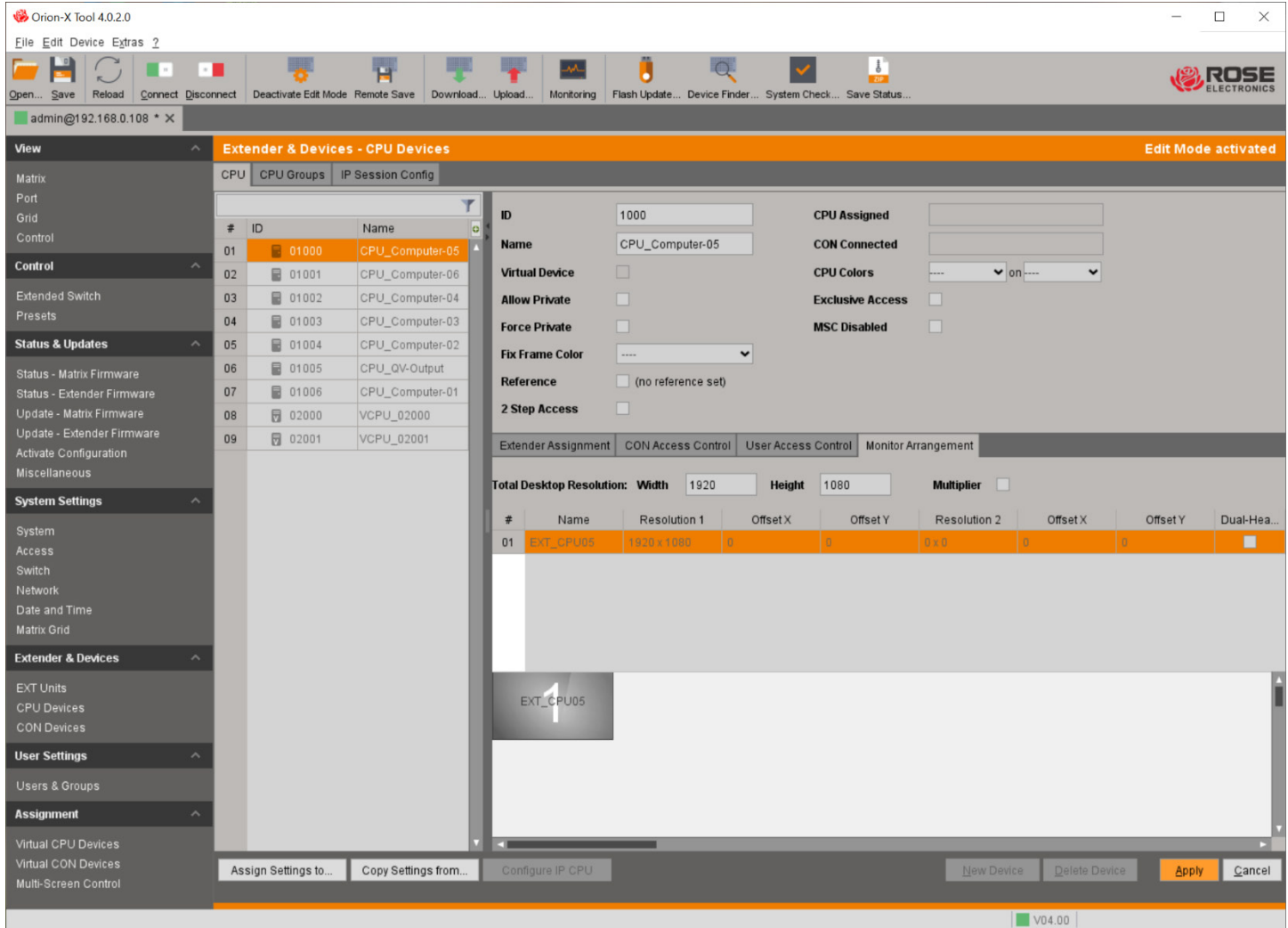

Figure 138. Multi-Head Multi-Screen Configuration with the Java Tool

1. Select the CPU Device to be configured and open the **Monitor Arrangement** tab. Configuration of CPU devices connected to Single-Head sources is not required.
2. Enter the resolution of the total desktop area in the **Width** and **Height** fields of **Total Desktop Resolution**. For example, if there are 4 video source outputs with a resolution of 1920x1080 each, enter 7680 as **Width** and 1080 as **Height**.
3. Select the individual resolution of the graphic card output from the selection list in the **Resolution 1** field (for example, 1920x1080). This is the video output of the source to which the CPU Device is connected.
4. Enter the pixel coordinates of the CPU device in the Multi-Screen arrangement in the **Offset X** and **Offset Y** fields. For instance, enter 1920 into **Offset X** to shift the output in the Multi-Screen arrangement 1920 pixels to the right. The CPU device icon will be positioned accordingly in the grid.

If the CPU Device is a Dual-Head extender, click the **Dual-Head Extender** checkbox. Then enter the resolution of the second graphic card output and the offset information in the **Resolution 2** field, and the **Offset X** and **Offset Y** fields.

5. For some operating systems the **Multiplier** checkbox must be ticked if the mouse cursor does not reach all areas of the desktop.
6. Click the Apply button to save the changes. A pop-up menu will prompt to restart the extender, which is mandatory.

The Multi-head CPU device is now configured for use in a Multi-screen application.

## Saving and Loading of Configurations

The menus described in this section provide a variety of ways to save and recall configurations, whether currently active configurations, internally stored configurations, or configurations saved on media external to the Orion FX equipment.

There are two ways to save configuration changes internally:

1. Save as the active configuration in Orion FX memory.
2. Save in one of eight predefined storage locations in Orion FX memory. These can be loaded as the active configuration when required.

### *Saving the Current Configuration to the Orion FX*

This menu can be accessed in the OSD and the Java Tool.

➔ To save the Configuration with the OSD, select **Configuration** in the Main menu, log in, and select **Save**.

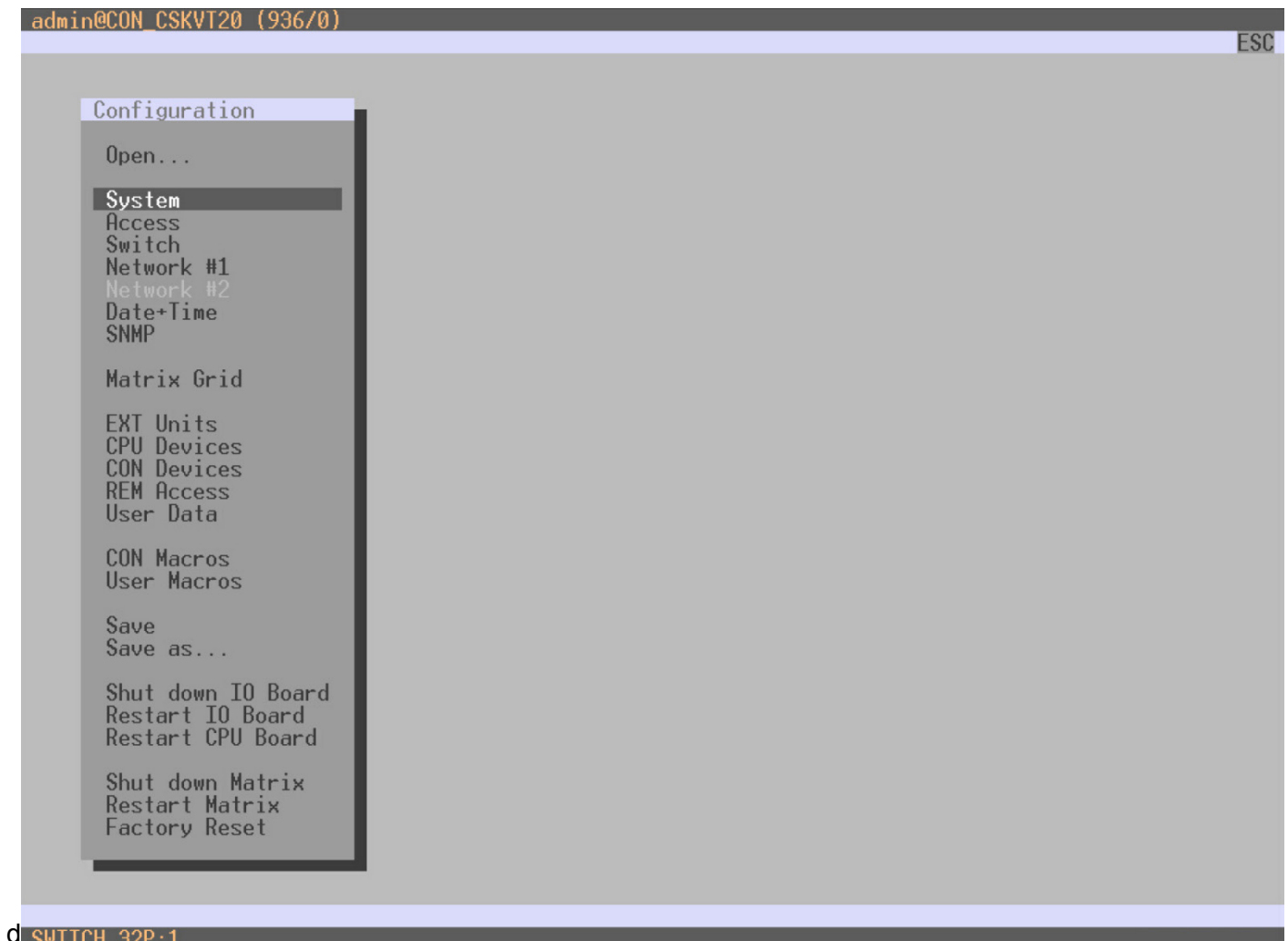

Figure 139. Configuration Save in the OSD

By selecting this menu item, the admin user can save the active configuration of the Orion FX to its non-volatile memory. By default, the last configuration saved in this way is restored as the active configuration after a restart of the matrix.

**Note:** Changing or saving configurations will block the matrix memory briefly, resulting in a freeze of all OSD menus for a few seconds. The connections between consoles and CPUs are not affected.

If **Auto Save** is activated in the **Configuration > System** settings, and if there are changes to the configuration or switching operations, the configuration will be saved every 10 minutes.

To save the current configuration with the Java tool:

1. Click the **Remote Save** menu item in the toolbar.

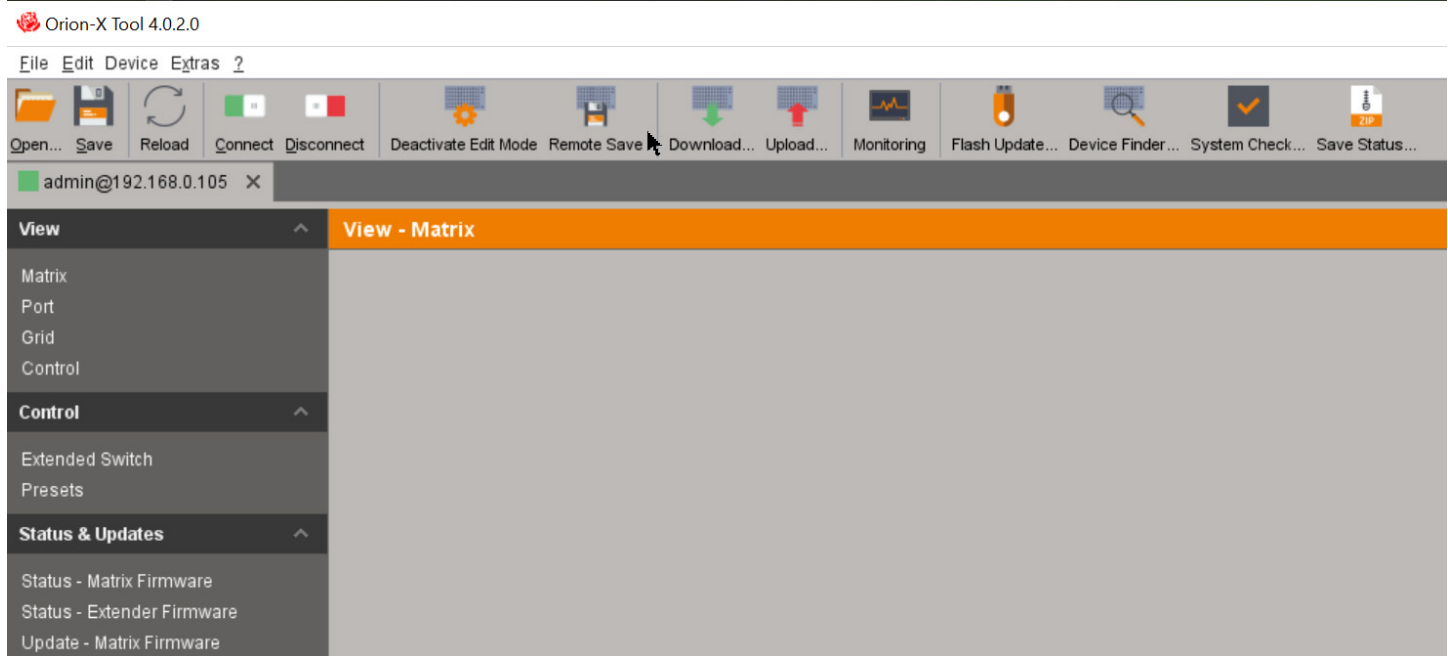

Figure 140. Remote Save in the Java Tool

2. When a prompt to confirm saving the configuration appears, click the **Yes** button. The previous Active Configuration is overwritten.

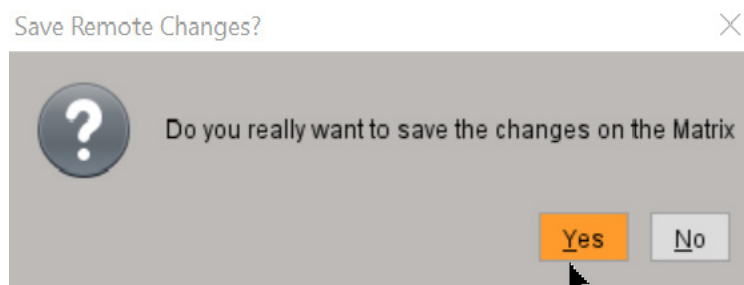

Figure 141. Remote Save Configuration Prompt in the Java Tool

## Saving the Configuration in a specific internal location

This menu allows storing the active configuration in a specific internal location. This does not replace the Active Configuration saved in the method described above, unless you choose the **Default** location. The menu can be accessed from the OSD and the Java Tool.

### Saving the Configuration to a Specific Storage using the OSD

It is possible to save the current configuration in one of eight storage locations in the Orion FX (**File #1** to **File #8**), as well as in the **Default** location (loaded each time the matrix restarts). **Active** shows the current configuration's name and information. **Default** and **File #1** to **File #8** show the name and information records of previously saved configurations. Each of these storage locations can be overwritten.

1. Select **Configuration** in the Main menu and log in.
2. Select **Save As...**
3. Select the desired storage location (**File #1 - File #8**) or **Default**.
4. Save the configuration by pressing the keyboard <Enter> key.

The current configuration is saved to the storage location, and the configuration previously saved at that location is overwritten.



Figure 142. Saving Configuration to Internal Storage Locations with the OSD

**Note:** To give the configuration a name and description before saving, see [Modifying System Settings through the OSD](#).

## Saving the Configuration to a Specific Location using the Java Tool

To save the current configuration in the internal memory, proceed as follows:

1. Select **File > Upload** in the menu bar.
2. Enter the IP address of the Orion FX, your user name and password and confirm the inputs with the **Next** button.

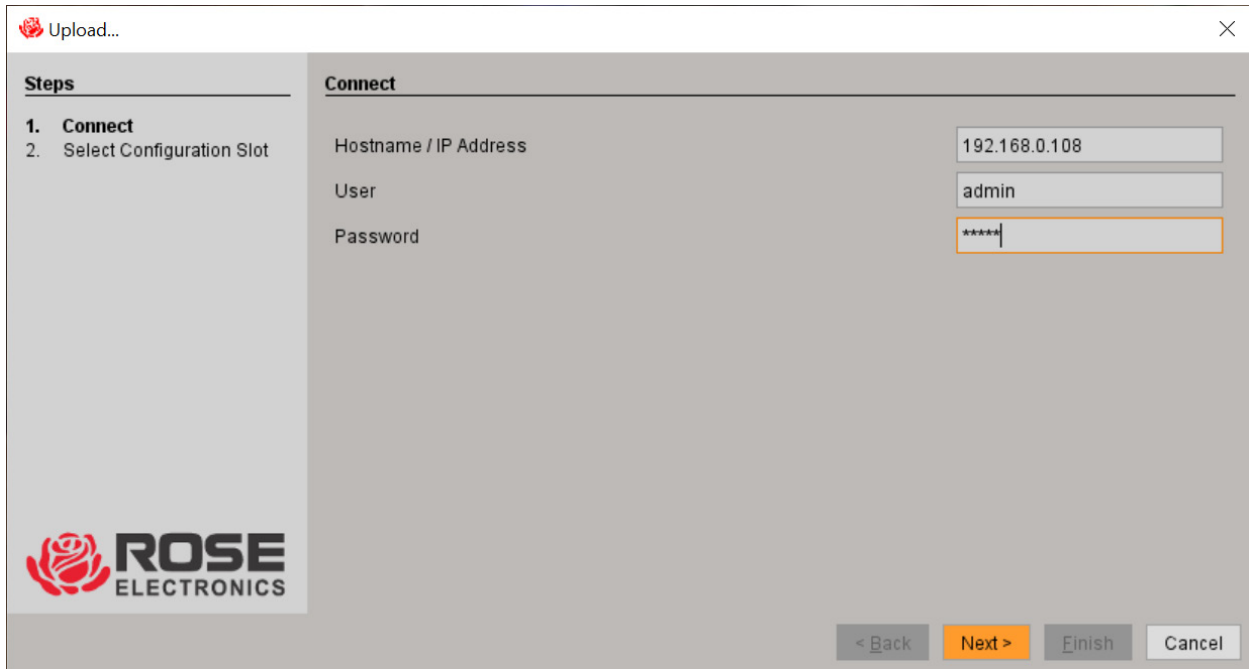

Figure 143. Saving Configuration to Internal Storage with the Java Tool

3. Select the storage location in which the configuration is to be saved (**Default**, or **File #1 – File #8**) and confirm with the **Finish** button.

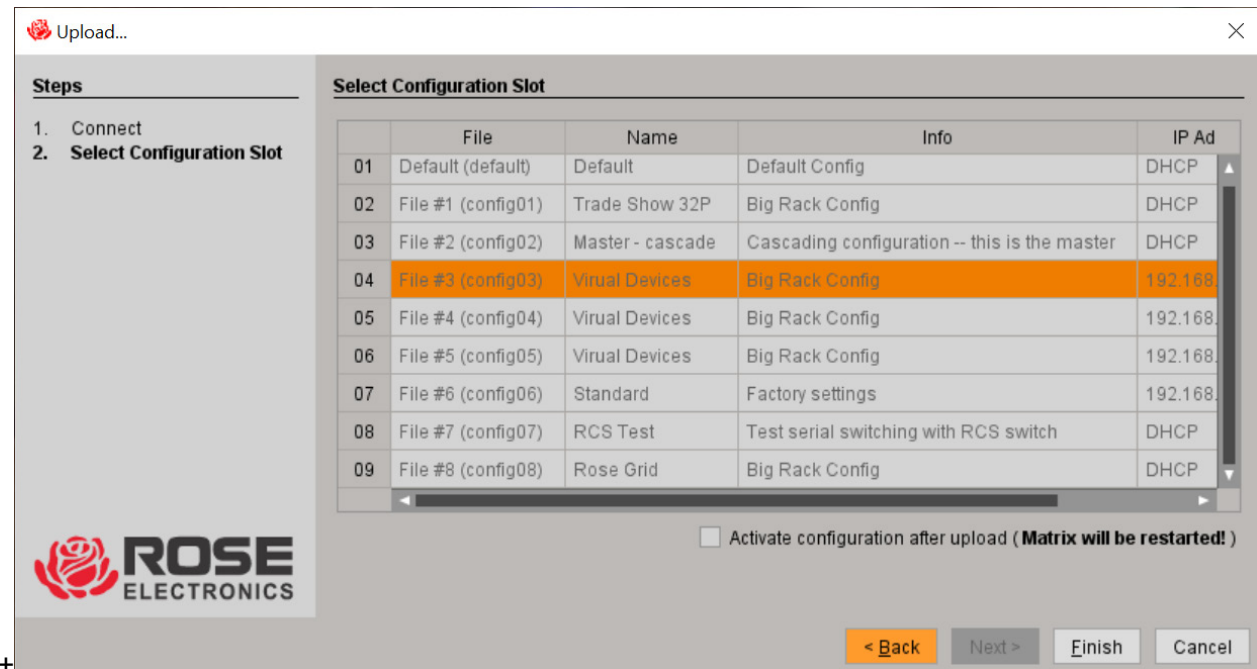

Figure 144. Select a Configuration Internal Storage Location with the Java Tool

## Loading Configurations from Internal Memory

In this menu, configurations previously saved to internal memory are loaded to become the active configuration. This menu can be accessed from the OSD and the Java Tool.

### Loading a Configuration from Internal Memory with the OSD



Figure 145. Loading Internal Configuration through the OSD

**Active** shows the current configuration's name. In addition to the default configuration, one of eight other configurations can be loaded.

To load the configuration from the Orion FX internal memory, proceed as follows:

1. Select **Configuration** in the Main menu and log in.
2. Select **Open**.
3. Select the desired configuration.
4. Load the configuration by clicking the **Okay** button.

## Loading a Configuration from Internal Memory with the Java Tool

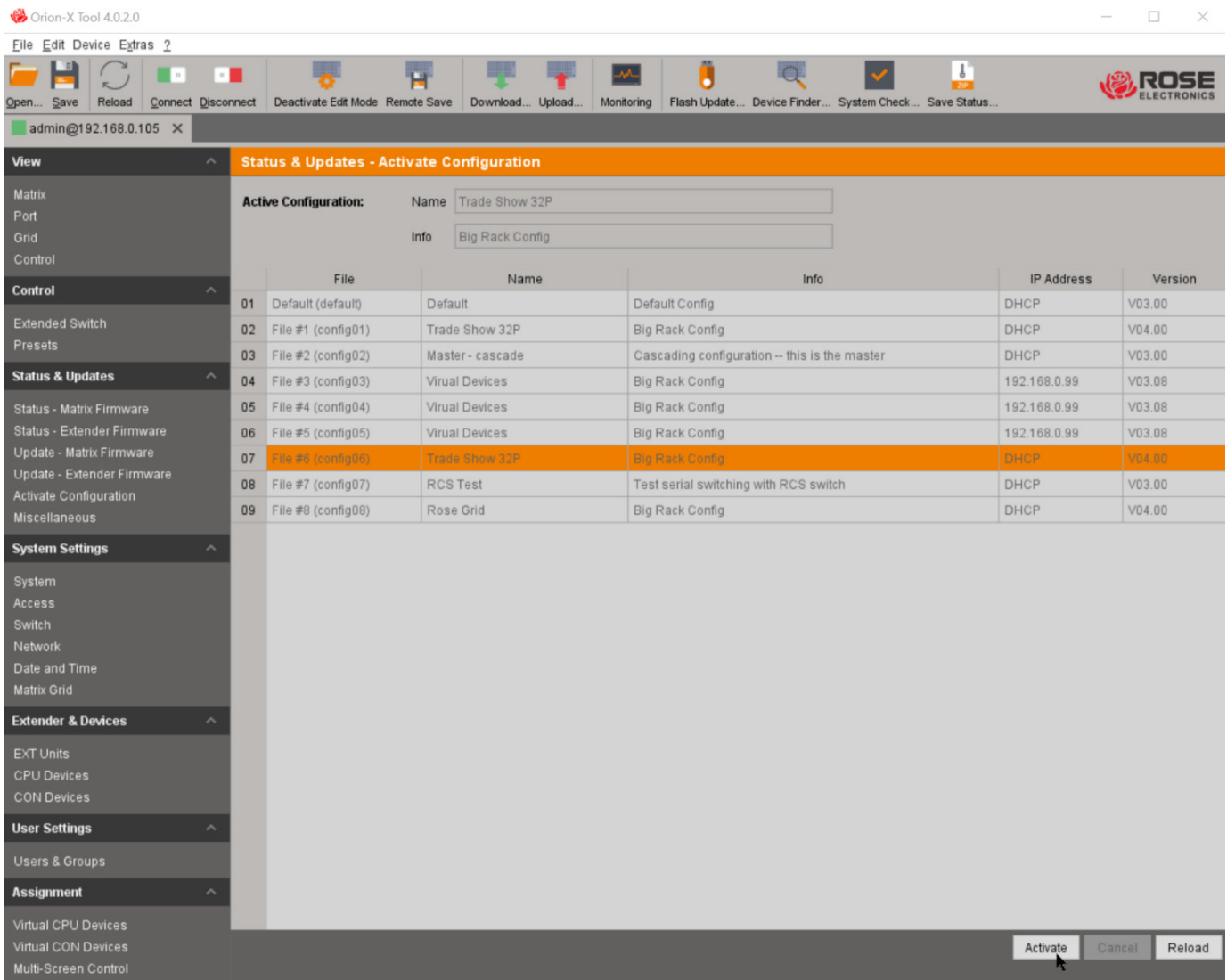

Figure 146. Loading Internal Configuration through the Java Tool

To load a saved configuration from Orion FX internal memory, proceed as follows:

1. Select **Status & Updates > Activate Configuration** in the task area. Be sure Edit Mode is active.
2. Select the required configuration.
3. Load the configuration by clicking the **Activate** button.

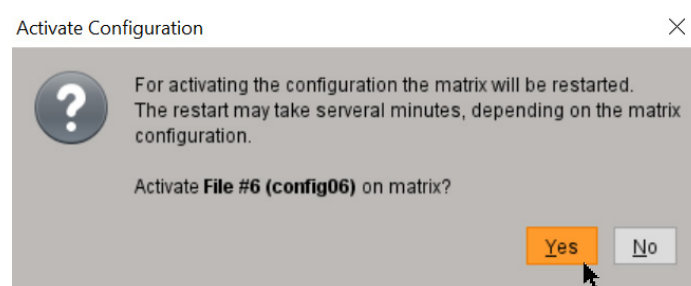

Figure 147. Prompt to Activate Loaded Configuration

4. A query to restart the Orion FX will be displayed. Click the **Yes** button. The connection to Orion FX will be disconnected and the Orion FX will restart with the selected configuration loaded and shown as the Active Configuration.

## Saving of Configurations (External)

Configurations can also be saved as files which are stored outside of the matrix. This menu can only be accessed from the Java Tool.

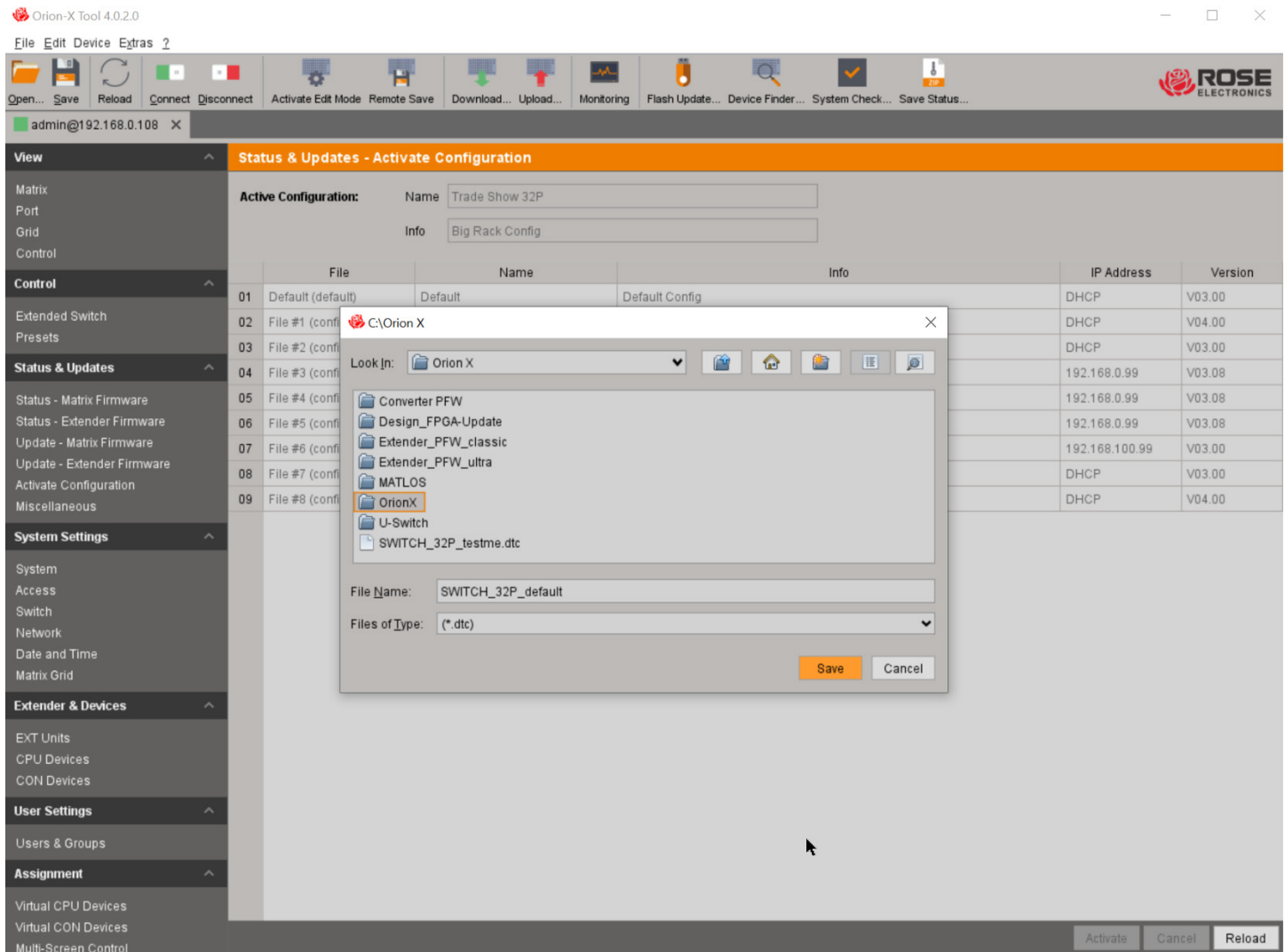

Figure 148. Saving External Configuration through the Java Tool

To save the active configuration as an external configuration file, proceed as follows:

1. Select **File > Save As** in the menu bar.
2. Select the directory in the Java Tool computer where the configuration file is to be saved.
3. Enter a file name for the configuration.
4. Click the Save button.

Configurations files have the extension “dtc”.

## Loading of Configurations (external)

Externally saved configuration files are opened and activated in this menu. This menu can only be accessed in the Java Tool.

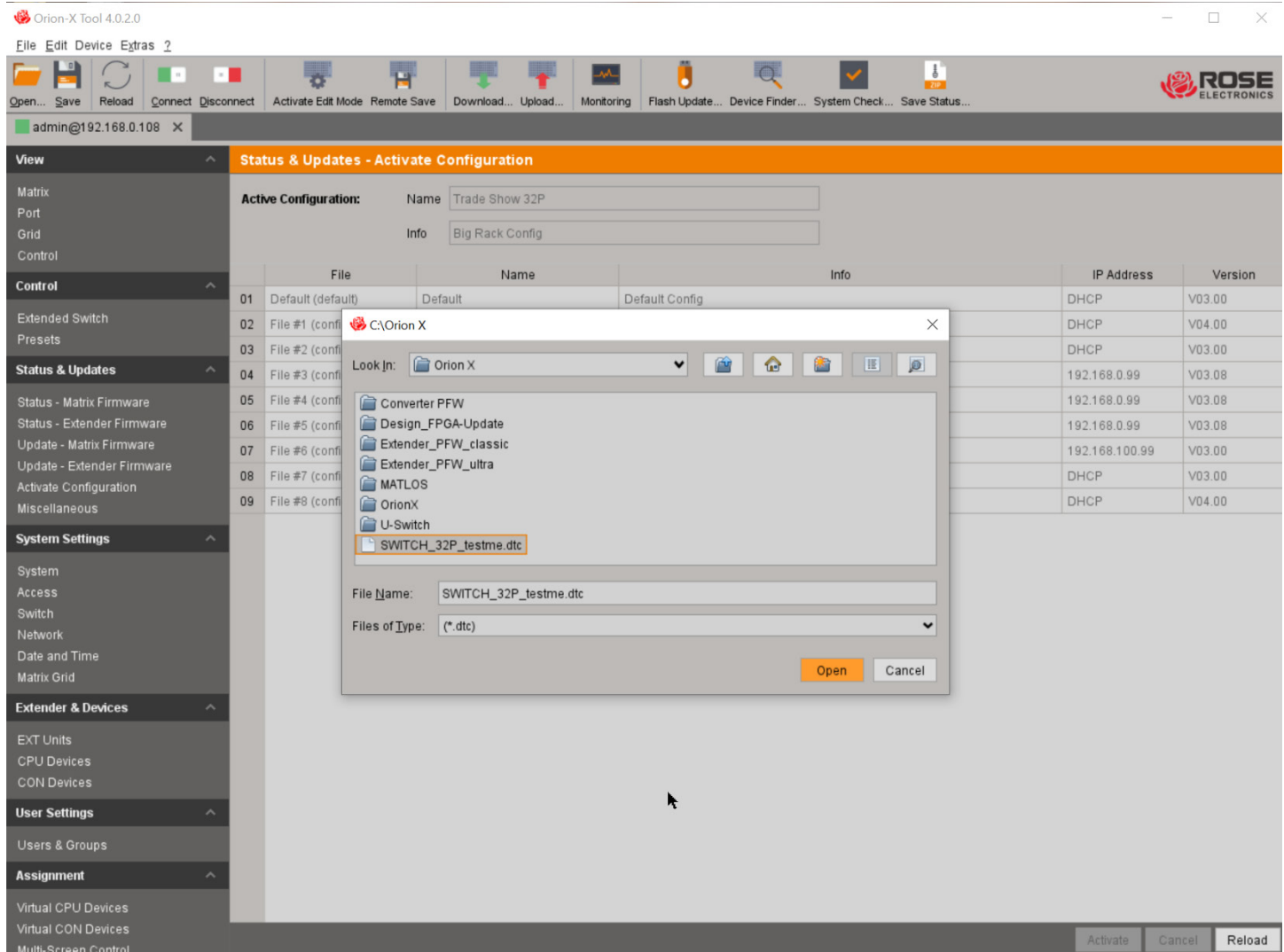

Figure 149. Loading external configuration through the Java Tool

To load an external configuration file, proceed as follows:

1. Select **File > Open...** when Edit Mode is not active, and select the storage location and configuration file that is to be opened.
2. Open the configuration by clicking the **Open** button.

3. Select **File > Upload** in the menu bar to transfer the opened configuration to the matrix. Enter Orion FX IP address, the admin login name and password, and click the **Next** button.

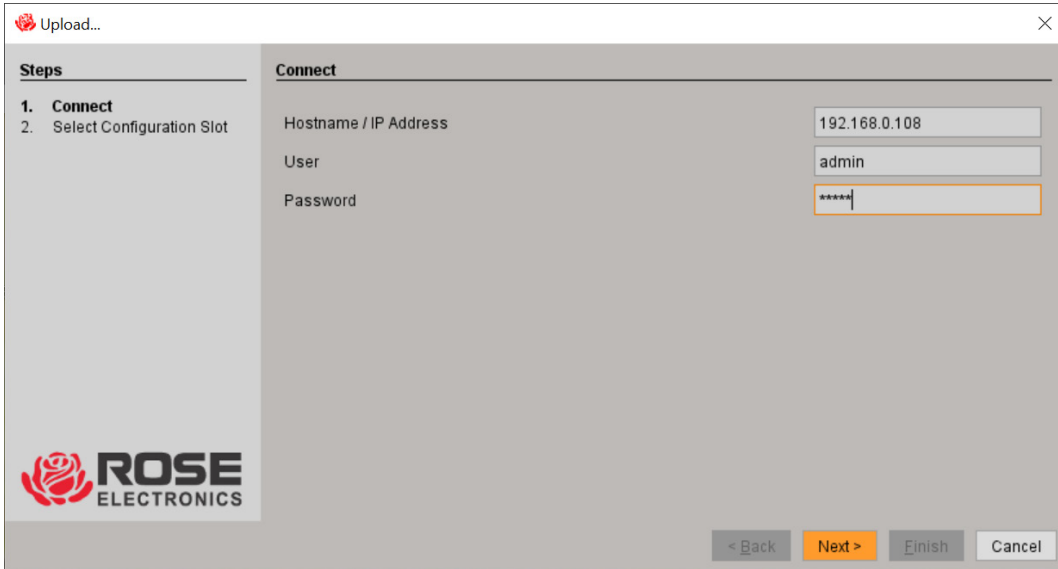

Figure 150. File Upload of Externally Saved Configuration in the Java Tool

4. Select the Configuration Slot to store the configuration.

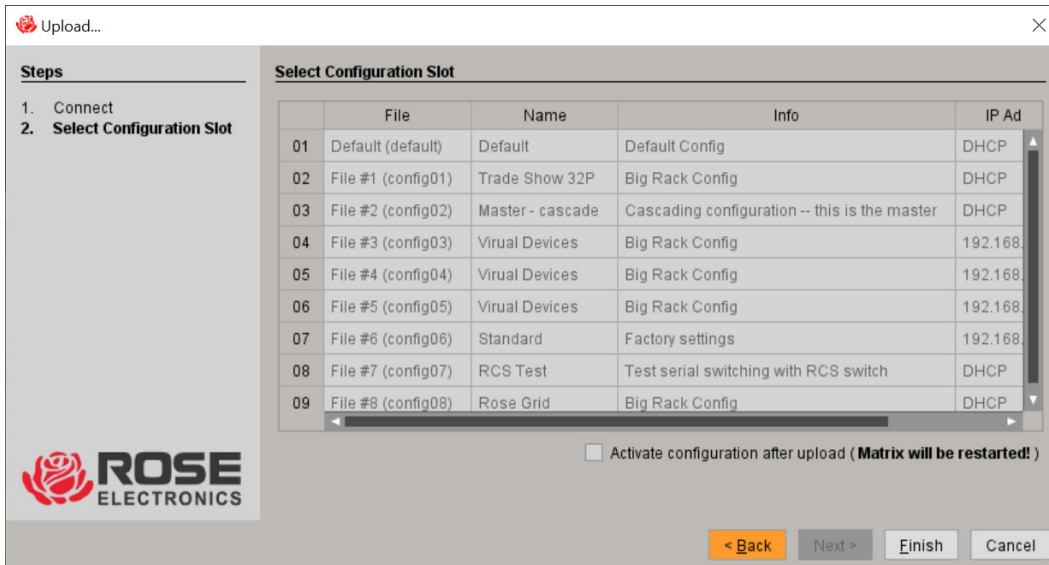

Figure 151. Selecting a Slot to Store the Externally Saved Configuration in the Java Tool

5. To make the configuration active after the upload, click the check box (Orion FX will restart).
6. Click the **Finish** button.

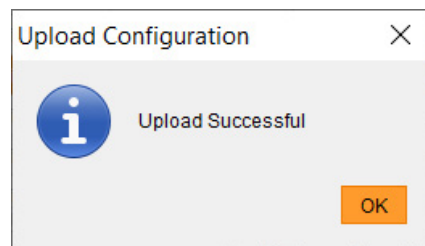

Figure 152. Completed Loading of Externally Stored Configuration in the Java Tool

## Export and Import Options

The Orion FX offers the option to export configuration lists (extender, CPUs, consoles and users) and import them again with the Java Tool. Exported configuration lists are always saved as files with the .csv extension, for ease of offline editing with common spreadsheet applications.

### Export Options

To export a configuration list, proceed as follows:

1. Select **File > Export** in the menu bar.
2. Select the list to export and click the **Next** button.

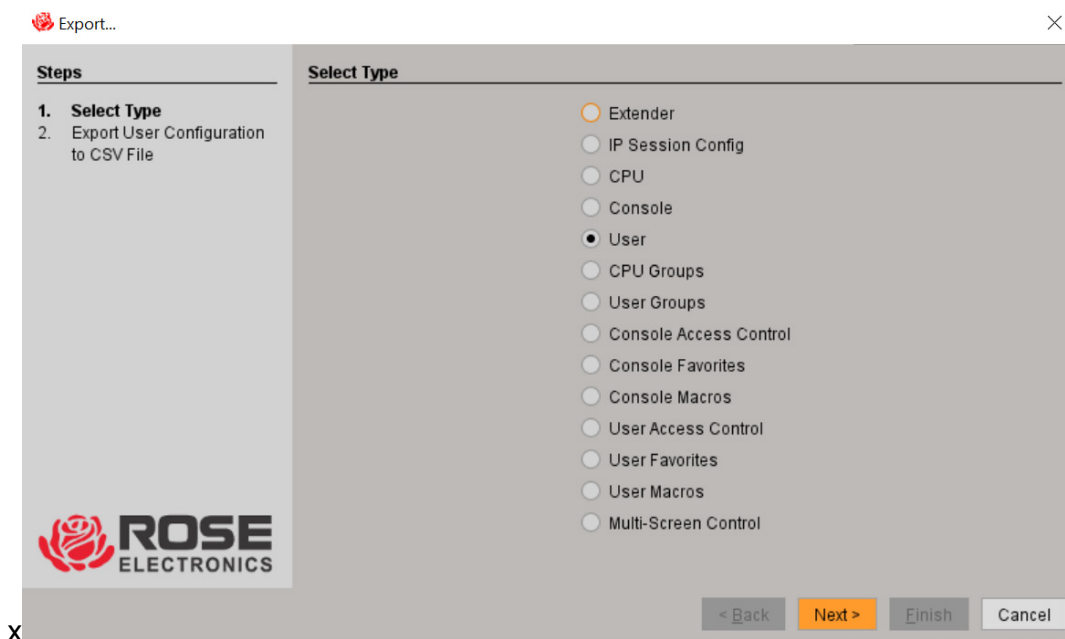

Figure 153. Exporting Configuration Lists in the Java Tool

3. Select the storage location and enter a name for the export file.

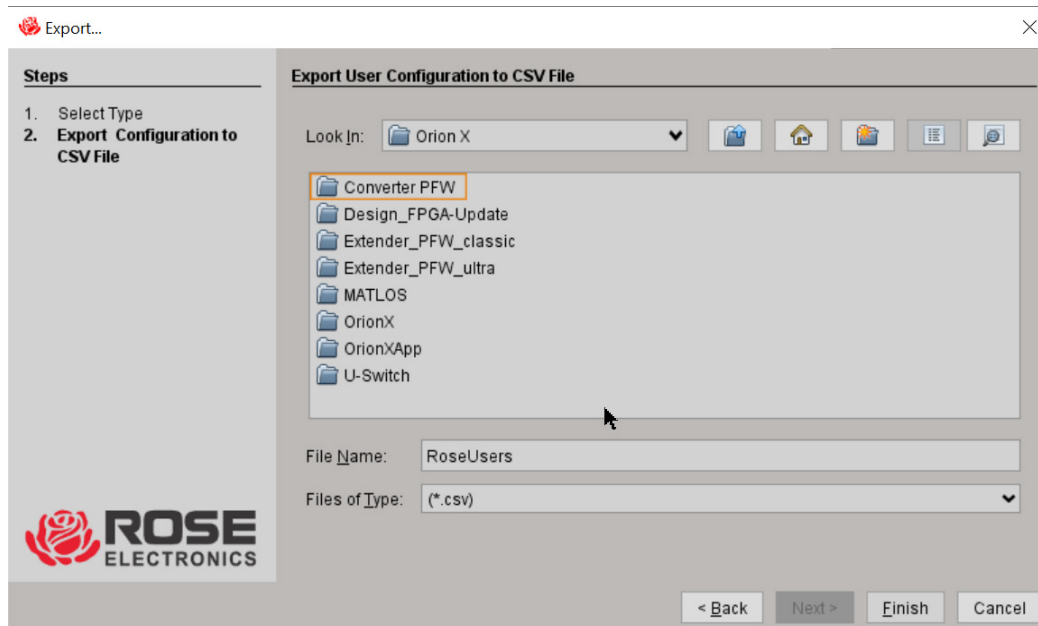

Figure 154. Configuration List File Name and Storage Location in the Java Tool

4. Confirm the export by clicking the **Finish** button.

## Import Options

Configuration lists can be imported into inactive configurations with this Java menu. Importing configuration lists is only possible when an external configuration file (.dct) has been opened.

To import a configuration list, proceed as follows:

1. Select **File > Import** in the menu bar of an offline configuration.
2. Select the type of list to import and click the **Next** button.

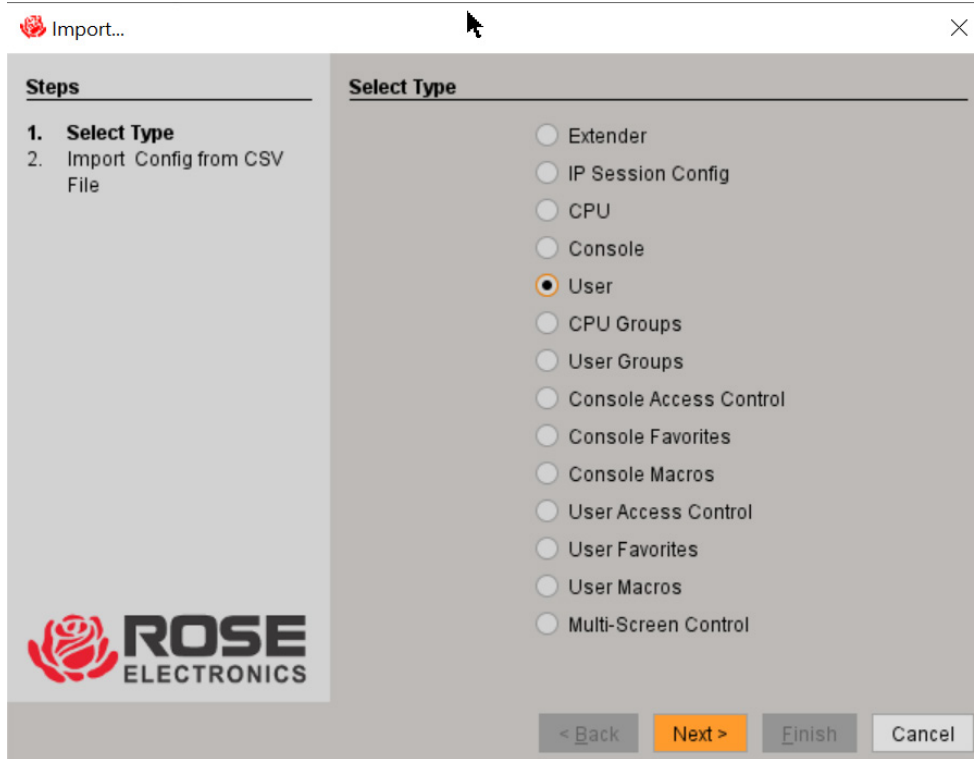

Figure 155. Importing a Configuration List in the Java Tool

3. Select the directory and Configuration list file to import.

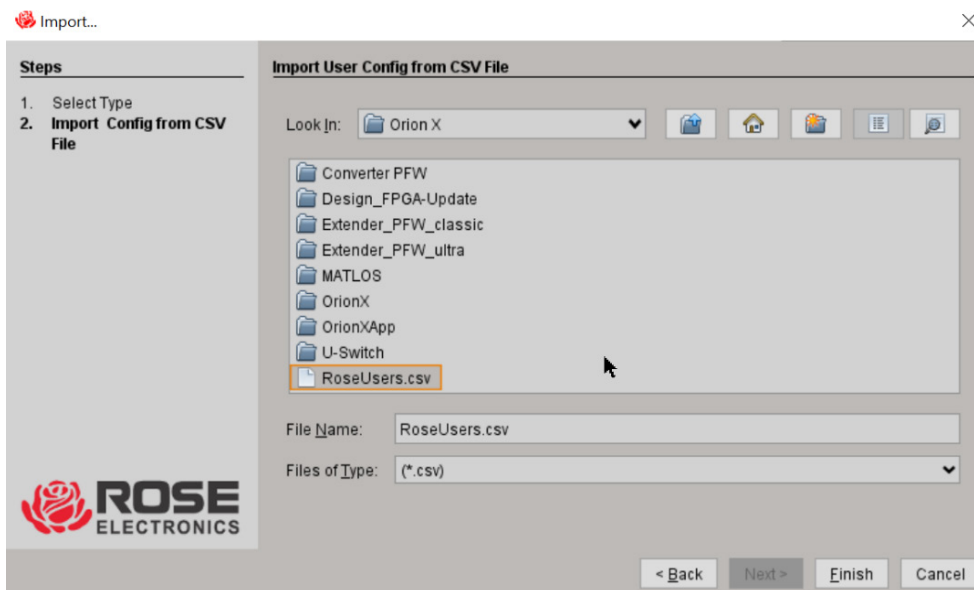

Figure 156. Importing Configuration Lists through the Java Tool

4. Confirm the import by clicking the **Finish** button.

## Matrix Cascading

Cascading allows a switchable connection to be established between two Orion FX switches through **Tie Lines**. This kind of configuration may be useful when the number of ports in the entire system needs to be increased, or when important connections should be distributed to several Orion FX switches for redundancy.

Tie Lines are unidirectional and can only be used in one direction according to their configuration. For cascading with bidirectional signal flows, two Tie Lines have to be set up in opposite directions. To use Tie Lines between Orion FX switches, **Cascade CON** and **Cascade CPU** devices must be created for switching within the cascaded environment.

Matrix Cascading can be configured with the OSD or the Java Tool.

### Setting Up Matrix Cascading through the OSD

1. Select an Orion FX to be the Master Matrix. All other connected matrix switches will be configured as Sub Matrices in the configuration process. Tie Lines must not be connected until the configuration process is completed.
2. Open the OSD of the Master Matrix, select **Configuration** in the Main menu and log in.
3. Select **EXT Units**.

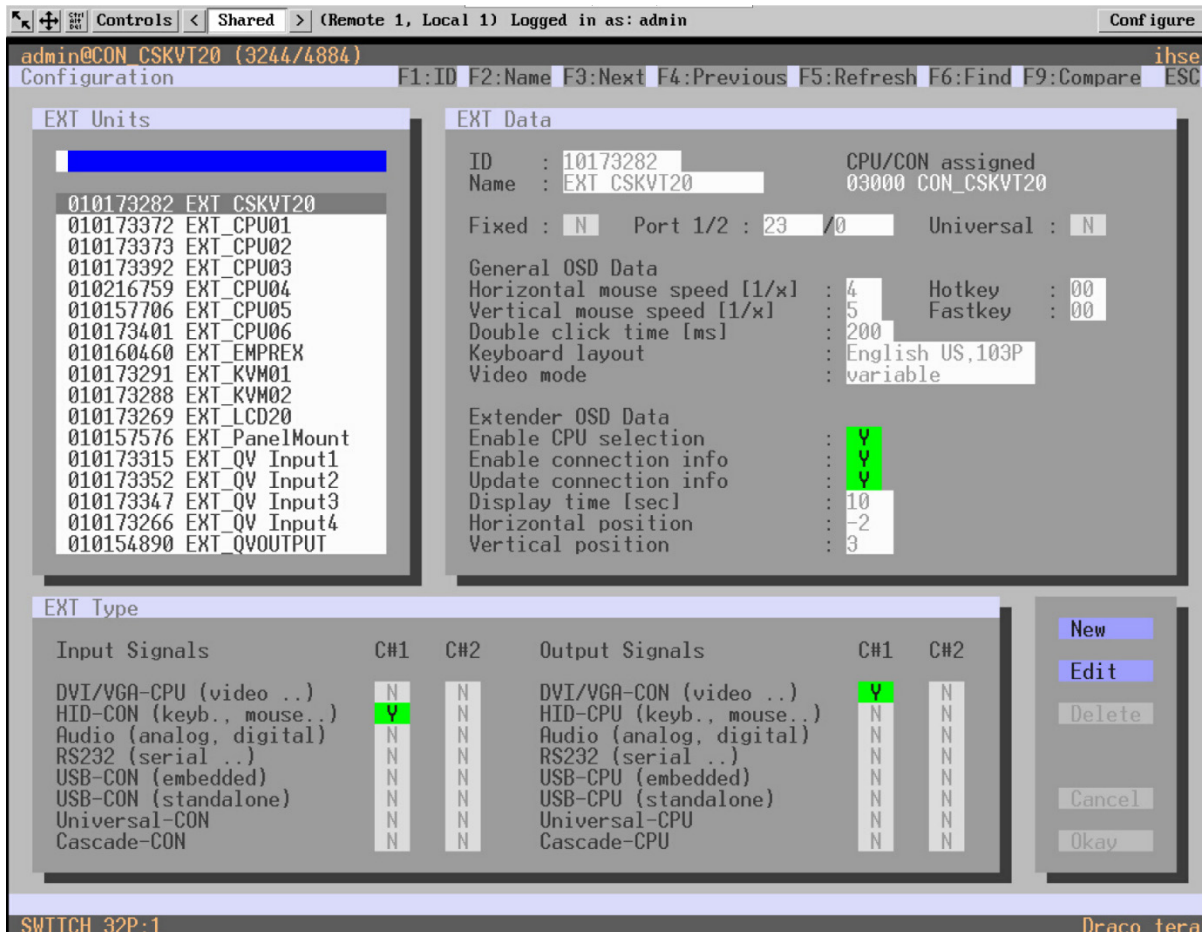

Figure 157. Setting Up Matrix Cascading Through the OSD

4. Click the **New** button. A new Extender Unit to be connected to Tie Lines will be created.
5. Enter an appropriate extender name in the **Name** field.
6. Enter a port number in the **Port** field based on where the Tie Line is to be connected.

7. If the Tie Line's direction is to be from the Sub Matrix to the Master Matrix, set the **Cascade-CON** option to **Y (C#1)** in the **Input Signals** column. If the Tie Line's direction is to be from the Master Matrix to the Sub Matrix, set the **Cascade-CPU** option to **Y (C#1)** in the **Output Signals** column.
8. Save the settings by pressing the **Okay** button.
9. If a Master/Sub CON Unit was created, select **Configuration > CON Devices** in the main menu of the master matrix and press the **New R.** button. A switchable CON Device will be created.
10. If a Master/Sub CPU Unit was created, select **Configuration > CPU Devices** in the main menu of the master matrix and press the **New R.** button. A switchable CPU Device will be created.
11. Enter an appropriate Device name in the **Name** field.
12. Assign the previously configured Extender Unit to the newly created Device by moving the Extender Unit from the **Ext available** field to the **Ext assigned** field and save the settings.
13. Select **Configuration > EXT Units** in the main menu of the Sub matrix, and repeat steps 2 to 12 for the Sub Matrix.
14. Select **Configuration > System** in the main menu of the Sub Matrix and set the **Sub Matrix** option to **Y**. The OSD of the Sub Matrix will immediately freeze and will be only accessible by using the keyboard command <'Hot Key'>, <s>, <o>.
15. Restart all I/O boards on which any **Cascade CON** or **CPU** Units have been configured, or alternatively restart the Orion FX switches.
16. Connect the Tie Lines to the matrix switches. Ensure that each **Cascade CON** on one matrix is connected to the **Cascade CPU** on the other matrix to be able to switch between the two Orion FX units.

The Matrix Cascading is now configured and ready be used. Additional Tie Lines can be configured as needed.

## Setting Up Matrix Cascading through the Java Tool

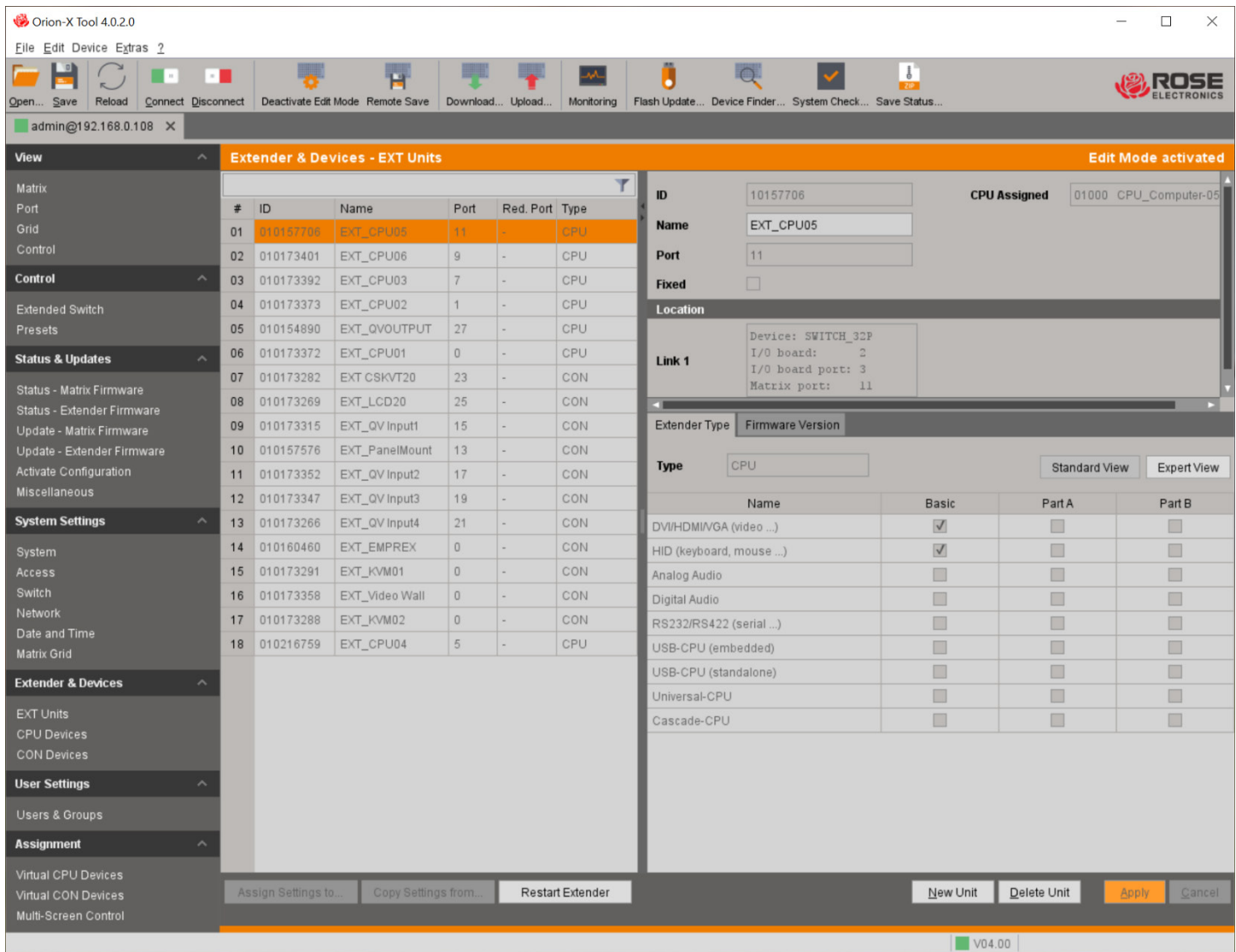

Figure 158. Setting Up Matrix Cascading Through the Java Tool

1. Connect to the Master Matrix and then select **Activate Edit Mode**.
2. Select **Extender & Devices > EXT Units** in the task area.
3. Click the **New Unit** button. This opens a pop-up selection window.

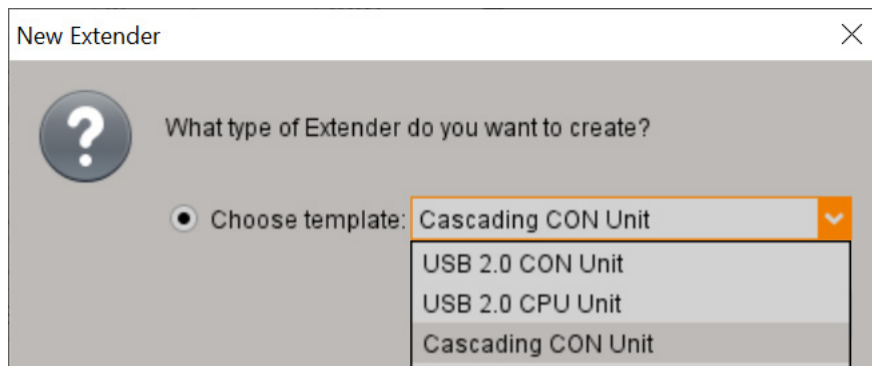

Figure 159. Creating New Cascade Units with the Java Tool

4. If the Tie Line should be directed from the Sub Matrix to the Master Matrix, select **Cascading CON Unit** in the selection box. If the Tie Line should be directed from the Sub Matrix to the Master Matrix, select **Cascading CPU Unit** in the selection box.
5. Enter an appropriate extender name in the **Name** field.
6. Enter the port number where the Tie Line is to be connected into the **Port** field.
7. Confirm the settings by clicking the **Apply** button.
8. If a Cascading CON Unit was created, select **Extender & Devices > CON Devices** in the task area of the master matrix and click the **New Device** button. A switchable CON Device will be created.
9. If a Cascading CPU Unit was created, select **Extender & Devices > CPU Devices** in the task area of the Master Matrix and press the **New Device** button. A switchable CPU Device will be created.
10. Enter an appropriate name for the extender into the **Name** field.
11. Assign the previously configured Extender Unit to the newly created Device by moving the Unit's definition from the **Extender available** field to the **Extender assigned** field, and save the settings by clicking the **Apply** button.
12. Connect to the Sub Matrix and select **Activate Edit Mode**. Repeat steps 2 to 11.
13. Select **System Settings > System** in the task area of the Sub Matrix and activate the **Sub Matrix** option. The OSD of the Sub Matrix will be only accessible by using the keyboard command '<Hot Key>', '<s>', '<o>'.
14. Restart all I/O boards on which any Cascading CON or CPU Units have been configured, or alternatively restart the matrix switches.
15. Now connect the Tie Lines to the matrix ports. Ensure that each **Cascade CON** on one matrix is connected to a **Cascade CPU** on the other matrix to enable switching between the two switches.

The Matrix Cascading is now configured and can be used. Additional Tie Lines can be configured as needed.

## Matrix Grid

This menu is used to configure a Matrix Grid connecting two or more Orion FX switches. This may be necessary if the total number of ports in the entire system needs to be increased, or if connections to important equipment should be distributed among several Orion FX switches for redundancy.

The connections between two matrix switches are established through **Grid Lines** that are connected between particular I/O ports. The Grid Lines are bi-directional, and each can handle a full access connection of a CON Device to a CPU Device.

The number of Grid Lines in the system determines whether a CON Device can be switched to a CPU Device with Non-Blocking Access or with Blocking Access. This has to be determined for each Grid environment. Non-Blocking Access means that a Grid Line for cross-matrix switching of a CON Device to a CPU Device is available at any time. Blocking Access means that for a specific switching operation, no Grid Line may be available due to the current connection status within the Grid. In that case, cross-matrix switching may not be possible.

Matrix Grids can be configured through the OSD or the Java Tool.

### *Administration of Settings*

Within a Matrix Grid, some settings are made locally to each Orion FX switch, and others are global settings that apply to the whole Matrix Grid.

These settings have to be made separately for each matrix (local settings), or within the master matrix (the Grid Master) to affect all matrix switches in the Grid (global setting): **System, Access, Switch, Network, Date + Time, SNMP, Matrix Grid, Multi-Screen Control.**

These settings have to be made once globally within the Matrix Grid: **EXT Units, CPU Devices, CON Devices, User, CON Macros, User Macros, CON Favorites, User Favorites, Virtual CPU Devices, Virtual CON Devices.** Global settings made in these menus will be immediately available on each matrix within the Matrix Grid.

### *General Preparation*

The following conditions must be met before starting the Matrix Grid configuration:

1. Firmware Revision V04.00 or later must be installed on all matrix switches that are to be connected to the Grid.
2. All matrix switches to be connected to the Grid must be within the same TCP/IP network.
3. Port 5556, which is needed for network communication, must not be blocked by a firewall.

## Setting Up a Matrix Grid through the OSD

In order to configure a Matrix Grid, proceed as follows. The following configuration steps have to be repeated for each Orion FX in the grid separately.

1. Select **Configuration** in the Main menu and log in.
2. Select **System**.

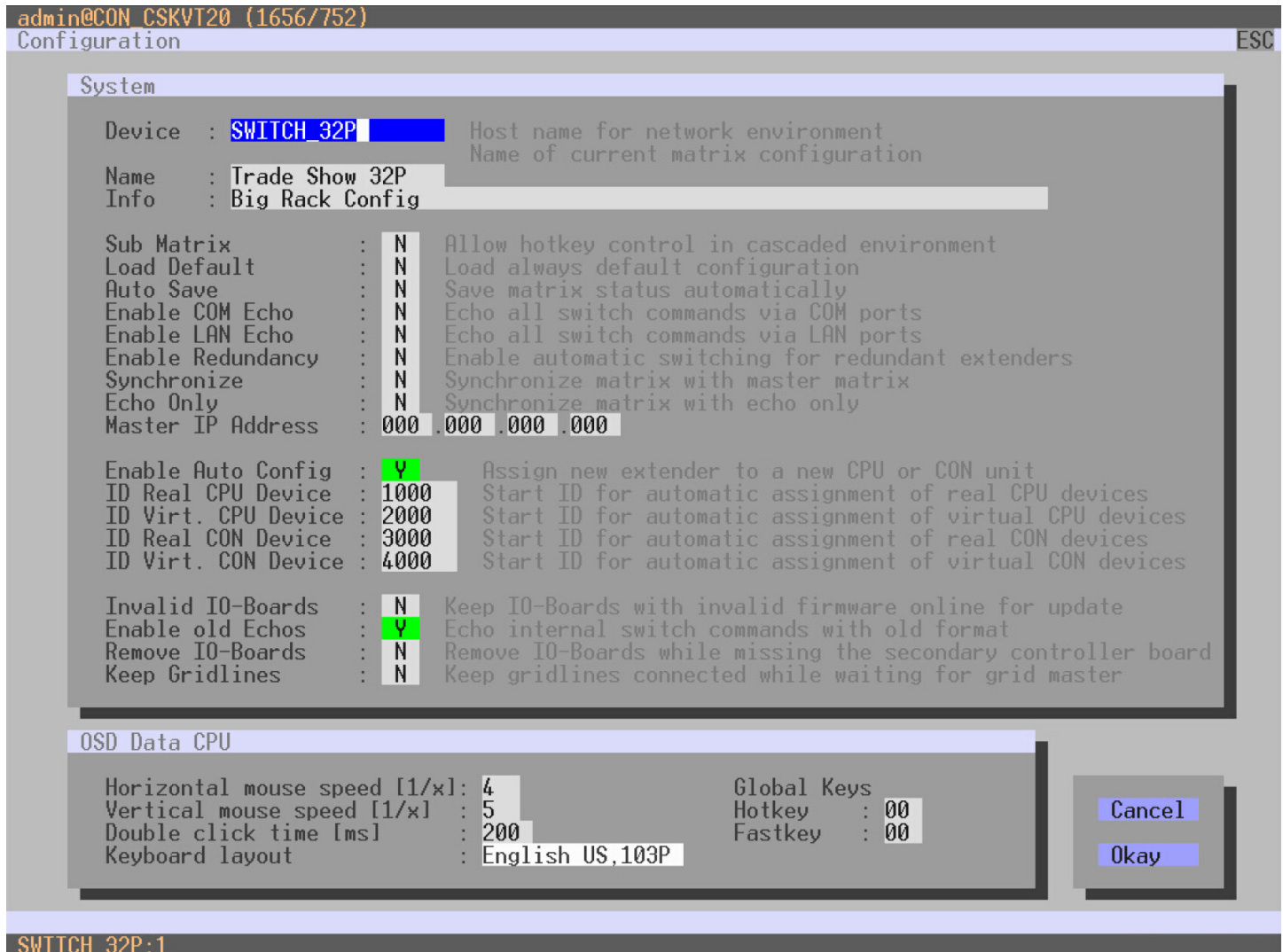

Figure 160. Setting Up a Matrix Grid through the OSD - Step 1

3. Enter a unique name for each Matrix switch into the **Device** field. No two matrix switches within the Matrix Grid can use the same name.
4. Enter a unique Grid name into the **Name** field. The Grid name must be the same on all Orion FX units in the Grid.
5. Confirm these name choices by clicking the Okay button.



## Setting Up a Matrix Grid through the Java Tool

1. Select System Settings > Matrix Grid in the Task area.

The screenshot shows the Orion-X Tool 4.0.2.0 interface. The main window is titled "System Settings - Matrix Grid" and has "Edit Mode activated". A "Start Grid Wizard (online)" button is visible in the "Matrix Grid Configuration" section. Below this, there is a "Matrix Grid Enabled" checkbox which is currently unchecked. The main area contains a table for configuring 32 matrix units (Matrix 01 to Matrix 32) across two network interfaces.

			Network Interface 1				Network Interface 2				Ports	Master	Master	
	Active	Online	Device	IP Address	GRID	API	SSL	IP Address	GRID	API				SSL
Matrix 01	<input type="checkbox"/>	<input type="checkbox"/>		0.0.0.0	<input type="checkbox"/>	<input type="checkbox"/>	<input type="checkbox"/>	0.0.0.0	<input type="checkbox"/>	<input type="checkbox"/>	<input type="checkbox"/>	0	<input type="checkbox"/>	<input type="button" value="Connect"/>
Matrix 02	<input type="checkbox"/>	<input type="checkbox"/>		0.0.0.0	<input type="checkbox"/>	<input type="checkbox"/>	<input type="checkbox"/>	0.0.0.0	<input type="checkbox"/>	<input type="checkbox"/>	<input type="checkbox"/>	0	<input type="checkbox"/>	<input type="button" value="Connect"/>
Matrix 03	<input type="checkbox"/>	<input type="checkbox"/>		0.0.0.0	<input type="checkbox"/>	<input type="checkbox"/>	<input type="checkbox"/>	0.0.0.0	<input type="checkbox"/>	<input type="checkbox"/>	<input type="checkbox"/>	0	<input type="checkbox"/>	<input type="button" value="Connect"/>
Matrix 04	<input type="checkbox"/>	<input type="checkbox"/>		0.0.0.0	<input type="checkbox"/>	<input type="checkbox"/>	<input type="checkbox"/>	0.0.0.0	<input type="checkbox"/>	<input type="checkbox"/>	<input type="checkbox"/>	0	<input type="checkbox"/>	<input type="button" value="Connect"/>
Matrix 05	<input type="checkbox"/>	<input type="checkbox"/>		0.0.0.0	<input type="checkbox"/>	<input type="checkbox"/>	<input type="checkbox"/>	0.0.0.0	<input type="checkbox"/>	<input type="checkbox"/>	<input type="checkbox"/>	0	<input type="checkbox"/>	<input type="button" value="Connect"/>
Matrix 06	<input type="checkbox"/>	<input type="checkbox"/>		0.0.0.0	<input type="checkbox"/>	<input type="checkbox"/>	<input type="checkbox"/>	0.0.0.0	<input type="checkbox"/>	<input type="checkbox"/>	<input type="checkbox"/>	0	<input type="checkbox"/>	<input type="button" value="Connect"/>
Matrix 07	<input type="checkbox"/>	<input type="checkbox"/>		0.0.0.0	<input type="checkbox"/>	<input type="checkbox"/>	<input type="checkbox"/>	0.0.0.0	<input type="checkbox"/>	<input type="checkbox"/>	<input type="checkbox"/>	0	<input type="checkbox"/>	<input type="button" value="Connect"/>
Matrix 08	<input type="checkbox"/>	<input type="checkbox"/>		0.0.0.0	<input type="checkbox"/>	<input type="checkbox"/>	<input type="checkbox"/>	0.0.0.0	<input type="checkbox"/>	<input type="checkbox"/>	<input type="checkbox"/>	0	<input type="checkbox"/>	<input type="button" value="Connect"/>
Matrix 09	<input type="checkbox"/>	<input type="checkbox"/>		0.0.0.0	<input type="checkbox"/>	<input type="checkbox"/>	<input type="checkbox"/>	0.0.0.0	<input type="checkbox"/>	<input type="checkbox"/>	<input type="checkbox"/>	0	<input type="checkbox"/>	<input type="button" value="Connect"/>
Matrix 10	<input type="checkbox"/>	<input type="checkbox"/>		0.0.0.0	<input type="checkbox"/>	<input type="checkbox"/>	<input type="checkbox"/>	0.0.0.0	<input type="checkbox"/>	<input type="checkbox"/>	<input type="checkbox"/>	0	<input type="checkbox"/>	<input type="button" value="Connect"/>
Matrix 11	<input type="checkbox"/>	<input type="checkbox"/>		0.0.0.0	<input type="checkbox"/>	<input type="checkbox"/>	<input type="checkbox"/>	0.0.0.0	<input type="checkbox"/>	<input type="checkbox"/>	<input type="checkbox"/>	0	<input type="checkbox"/>	<input type="button" value="Connect"/>
Matrix 12	<input type="checkbox"/>	<input type="checkbox"/>		0.0.0.0	<input type="checkbox"/>	<input type="checkbox"/>	<input type="checkbox"/>	0.0.0.0	<input type="checkbox"/>	<input type="checkbox"/>	<input type="checkbox"/>	0	<input type="checkbox"/>	<input type="button" value="Connect"/>
Matrix 13	<input type="checkbox"/>	<input type="checkbox"/>		0.0.0.0	<input type="checkbox"/>	<input type="checkbox"/>	<input type="checkbox"/>	0.0.0.0	<input type="checkbox"/>	<input type="checkbox"/>	<input type="checkbox"/>	0	<input type="checkbox"/>	<input type="button" value="Connect"/>
Matrix 14	<input type="checkbox"/>	<input type="checkbox"/>		0.0.0.0	<input type="checkbox"/>	<input type="checkbox"/>	<input type="checkbox"/>	0.0.0.0	<input type="checkbox"/>	<input type="checkbox"/>	<input type="checkbox"/>	0	<input type="checkbox"/>	<input type="button" value="Connect"/>
Matrix 15	<input type="checkbox"/>	<input type="checkbox"/>		0.0.0.0	<input type="checkbox"/>	<input type="checkbox"/>	<input type="checkbox"/>	0.0.0.0	<input type="checkbox"/>	<input type="checkbox"/>	<input type="checkbox"/>	0	<input type="checkbox"/>	<input type="button" value="Connect"/>
Matrix 16	<input type="checkbox"/>	<input type="checkbox"/>		0.0.0.0	<input type="checkbox"/>	<input type="checkbox"/>	<input type="checkbox"/>	0.0.0.0	<input type="checkbox"/>	<input type="checkbox"/>	<input type="checkbox"/>	0	<input type="checkbox"/>	<input type="button" value="Connect"/>
Matrix 17	<input type="checkbox"/>	<input type="checkbox"/>		0.0.0.0	<input type="checkbox"/>	<input type="checkbox"/>	<input type="checkbox"/>	0.0.0.0	<input type="checkbox"/>	<input type="checkbox"/>	<input type="checkbox"/>	0	<input type="checkbox"/>	<input type="button" value="Connect"/>
Matrix 18	<input type="checkbox"/>	<input type="checkbox"/>		0.0.0.0	<input type="checkbox"/>	<input type="checkbox"/>	<input type="checkbox"/>	0.0.0.0	<input type="checkbox"/>	<input type="checkbox"/>	<input type="checkbox"/>	0	<input type="checkbox"/>	<input type="button" value="Connect"/>
Matrix 19	<input type="checkbox"/>	<input type="checkbox"/>		0.0.0.0	<input type="checkbox"/>	<input type="checkbox"/>	<input type="checkbox"/>	0.0.0.0	<input type="checkbox"/>	<input type="checkbox"/>	<input type="checkbox"/>	0	<input type="checkbox"/>	<input type="button" value="Connect"/>
Matrix 20	<input type="checkbox"/>	<input type="checkbox"/>		0.0.0.0	<input type="checkbox"/>	<input type="checkbox"/>	<input type="checkbox"/>	0.0.0.0	<input type="checkbox"/>	<input type="checkbox"/>	<input type="checkbox"/>	0	<input type="checkbox"/>	<input type="button" value="Connect"/>
Matrix 21	<input type="checkbox"/>	<input type="checkbox"/>		0.0.0.0	<input type="checkbox"/>	<input type="checkbox"/>	<input type="checkbox"/>	0.0.0.0	<input type="checkbox"/>	<input type="checkbox"/>	<input type="checkbox"/>	0	<input type="checkbox"/>	<input type="button" value="Connect"/>
Matrix 22	<input type="checkbox"/>	<input type="checkbox"/>		0.0.0.0	<input type="checkbox"/>	<input type="checkbox"/>	<input type="checkbox"/>	0.0.0.0	<input type="checkbox"/>	<input type="checkbox"/>	<input type="checkbox"/>	0	<input type="checkbox"/>	<input type="button" value="Connect"/>
Matrix 23	<input type="checkbox"/>	<input type="checkbox"/>		0.0.0.0	<input type="checkbox"/>	<input type="checkbox"/>	<input type="checkbox"/>	0.0.0.0	<input type="checkbox"/>	<input type="checkbox"/>	<input type="checkbox"/>	0	<input type="checkbox"/>	<input type="button" value="Connect"/>
Matrix 24	<input type="checkbox"/>	<input type="checkbox"/>		0.0.0.0	<input type="checkbox"/>	<input type="checkbox"/>	<input type="checkbox"/>	0.0.0.0	<input type="checkbox"/>	<input type="checkbox"/>	<input type="checkbox"/>	0	<input type="checkbox"/>	<input type="button" value="Connect"/>
Matrix 25	<input type="checkbox"/>	<input type="checkbox"/>		0.0.0.0	<input type="checkbox"/>	<input type="checkbox"/>	<input type="checkbox"/>	0.0.0.0	<input type="checkbox"/>	<input type="checkbox"/>	<input type="checkbox"/>	0	<input type="checkbox"/>	<input type="button" value="Connect"/>
Matrix 26	<input type="checkbox"/>	<input type="checkbox"/>		0.0.0.0	<input type="checkbox"/>	<input type="checkbox"/>	<input type="checkbox"/>	0.0.0.0	<input type="checkbox"/>	<input type="checkbox"/>	<input type="checkbox"/>	0	<input type="checkbox"/>	<input type="button" value="Connect"/>
Matrix 27	<input type="checkbox"/>	<input type="checkbox"/>		0.0.0.0	<input type="checkbox"/>	<input type="checkbox"/>	<input type="checkbox"/>	0.0.0.0	<input type="checkbox"/>	<input type="checkbox"/>	<input type="checkbox"/>	0	<input type="checkbox"/>	<input type="button" value="Connect"/>
Matrix 28	<input type="checkbox"/>	<input type="checkbox"/>		0.0.0.0	<input type="checkbox"/>	<input type="checkbox"/>	<input type="checkbox"/>	0.0.0.0	<input type="checkbox"/>	<input type="checkbox"/>	<input type="checkbox"/>	0	<input type="checkbox"/>	<input type="button" value="Connect"/>
Matrix 29	<input type="checkbox"/>	<input type="checkbox"/>		0.0.0.0	<input type="checkbox"/>	<input type="checkbox"/>	<input type="checkbox"/>	0.0.0.0	<input type="checkbox"/>	<input type="checkbox"/>	<input type="checkbox"/>	0	<input type="checkbox"/>	<input type="button" value="Connect"/>
Matrix 30	<input type="checkbox"/>	<input type="checkbox"/>		0.0.0.0	<input type="checkbox"/>	<input type="checkbox"/>	<input type="checkbox"/>	0.0.0.0	<input type="checkbox"/>	<input type="checkbox"/>	<input type="checkbox"/>	0	<input type="checkbox"/>	<input type="button" value="Connect"/>
Matrix 31	<input type="checkbox"/>	<input type="checkbox"/>		0.0.0.0	<input type="checkbox"/>	<input type="checkbox"/>	<input type="checkbox"/>	0.0.0.0	<input type="checkbox"/>	<input type="checkbox"/>	<input type="checkbox"/>	0	<input type="checkbox"/>	<input type="button" value="Connect"/>
Matrix 32	<input type="checkbox"/>	<input type="checkbox"/>		0.0.0.0	<input type="checkbox"/>	<input type="checkbox"/>	<input type="checkbox"/>	0.0.0.0	<input type="checkbox"/>	<input type="checkbox"/>	<input type="checkbox"/>	0	<input type="checkbox"/>	<input type="button" value="Connect"/>

Figure 162. Setting Up a Matrix Grid through the Java Tool

2. Click the Start Grid Wizard (online) button

3. Verify each condition has been met, and click the Next button.

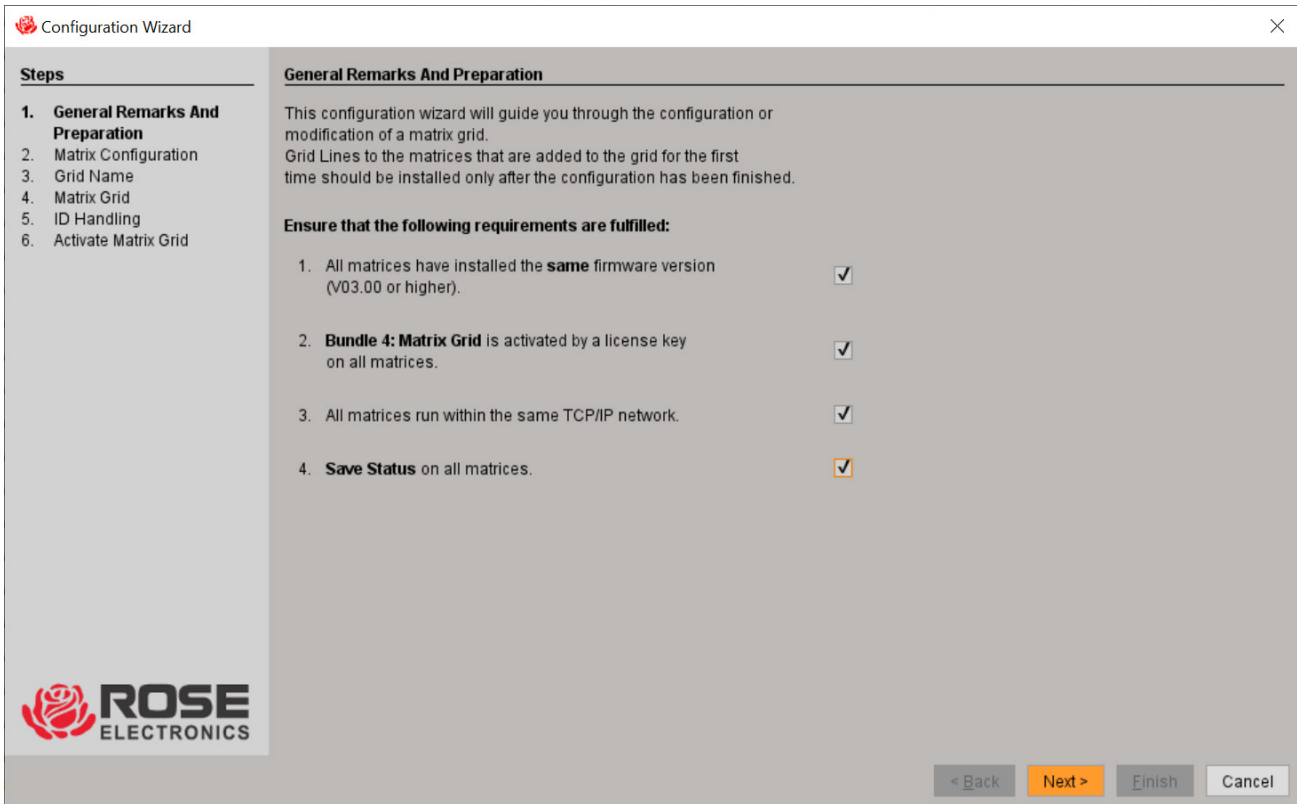

Figure 163. Matrix Grid Wizard in the Java Tool, Step 1

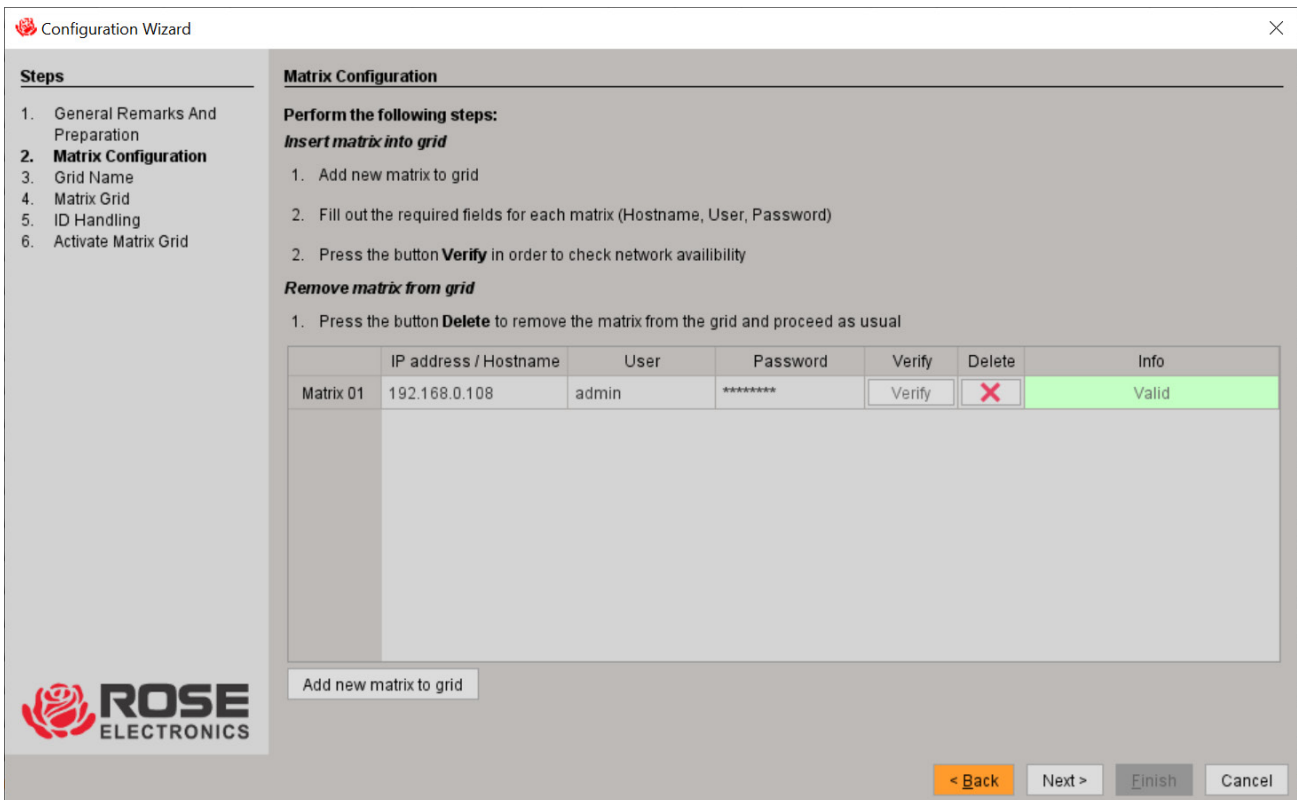

Figure 164. Matrix Grid Wizard in the Java Tool, Step 2

4. Proceed through each step in the Wizard to complete the Matrix Grid setup.

## Firmware Update

This topic includes updating the firmware on the Orion FX matrix and the extenders connected to it. Firmware update is available in the Java Tool.

### Matrix Update

The firmware of the Orion FX can be updated in this menu.

#### Notes:

- Only use stand-alone computers that are not connected as CPU devices to the matrix to update the matrix firmware.
- Ensure that the computer used for the update cannot go into standby mode or sleep mode during the update.
- Ensure that the current configuration has been saved externally before the update is started.
- For reasons of network stability, firmware update via direct LAN is recommended.
- Ensure that all USB 2.0 extender modules are only connected to their assigned ports (fixed ports) prior to beginning the update, or the stability of the update may be affected.

#### Preparation

Take the following steps in order to prepare for the matrix update:

1. Save the matrix configuration externally.
2. Open **Extras > Options** in the menu bar, and enter the path to the firmware update files in the **Firmware Directory** setting. Click the **Okay** button to confirm the path.
3. Put any spare boards intended for hot swapping into unused slots in the matrix.
4. Activate the Syslog function to monitor the update.

Ensure that all USB 2.0 extenders are only connected to their assigned ports (fixed ports) before the matrix update is started, or the stability of the update may be affected.

The following information is displayed in the working area:

Option	Description
<b>Name</b>	<ul style="list-style-type: none"><li>• Name of the chassis or I/O board</li><li>• Name of the chassis firmware or I/O board firmware</li></ul>
<b>Type</b>	The type of the chassis firmware
<b>Current Version</b>	Installed firmware version
<b>Update Version</b>	Firmware version available for update
<b>Status</b>	Module availability
<b>Update</b>	Selected / deselected for firmware update

Table 58. Firmware Update Options in the Java Tool

The following options are available in the **Additional selection options** drop-down menu of the **Update – Matrix firmware** menu:

Option	Description
<b>Expand Tree View</b>	Expand the tree view to show detailed information. This allows the user to select or deselect individual firmware to be updated.
<b>Collapse Tree View</b>	Collapse the tree view to hide detailed information. Individual firmware selection will not be possible.
<b>Select All</b>	Select all available firmware for update.
<b>Deselect All</b>	Deselect all selected firmware.

Table 59. Additional Selection Options in the Update firmware menu

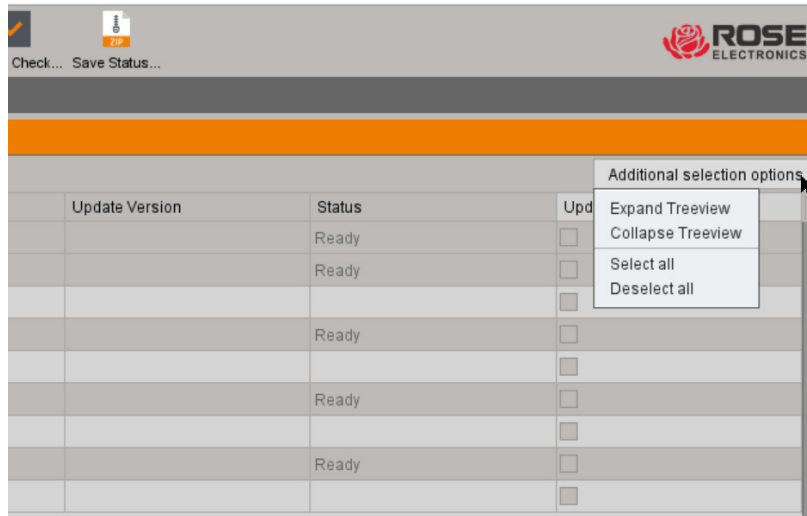

Figure 165. Additional Firmware Update Selection Options

### Performing the Update

To perform the matrix update, proceed as follows:

1. Select **Status & Updates > Update – Matrix Firmware** in the task area. All components of the matrix which are eligible for updates will be automatically selected and highlighted in green.

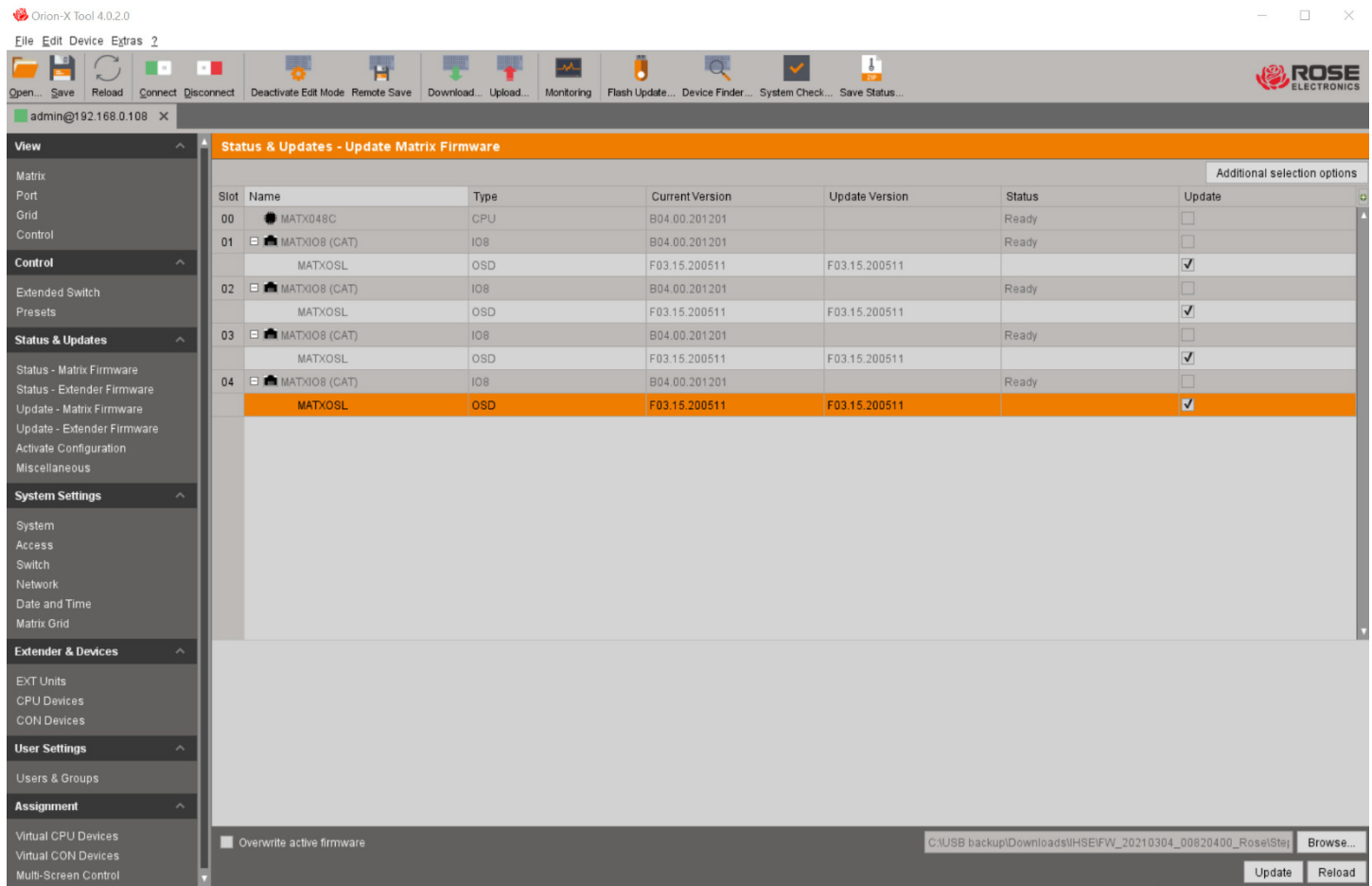
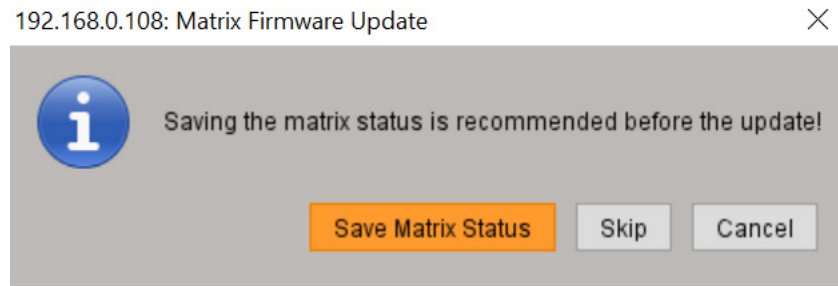

Figure 166. Update Matrix Firmware in the Java Tool

2. Deselect any components which are not be updated.
3. Start the update by clicking the **Update** button. A prompt to save the Matrix Status will be displayed.
4. Select the **Save Matrix Status** button to save the status locally, or click **Skip**.



**Figure 167. Save Matrix Status Prompt**

5. The progress of the update is displayed in the working area.

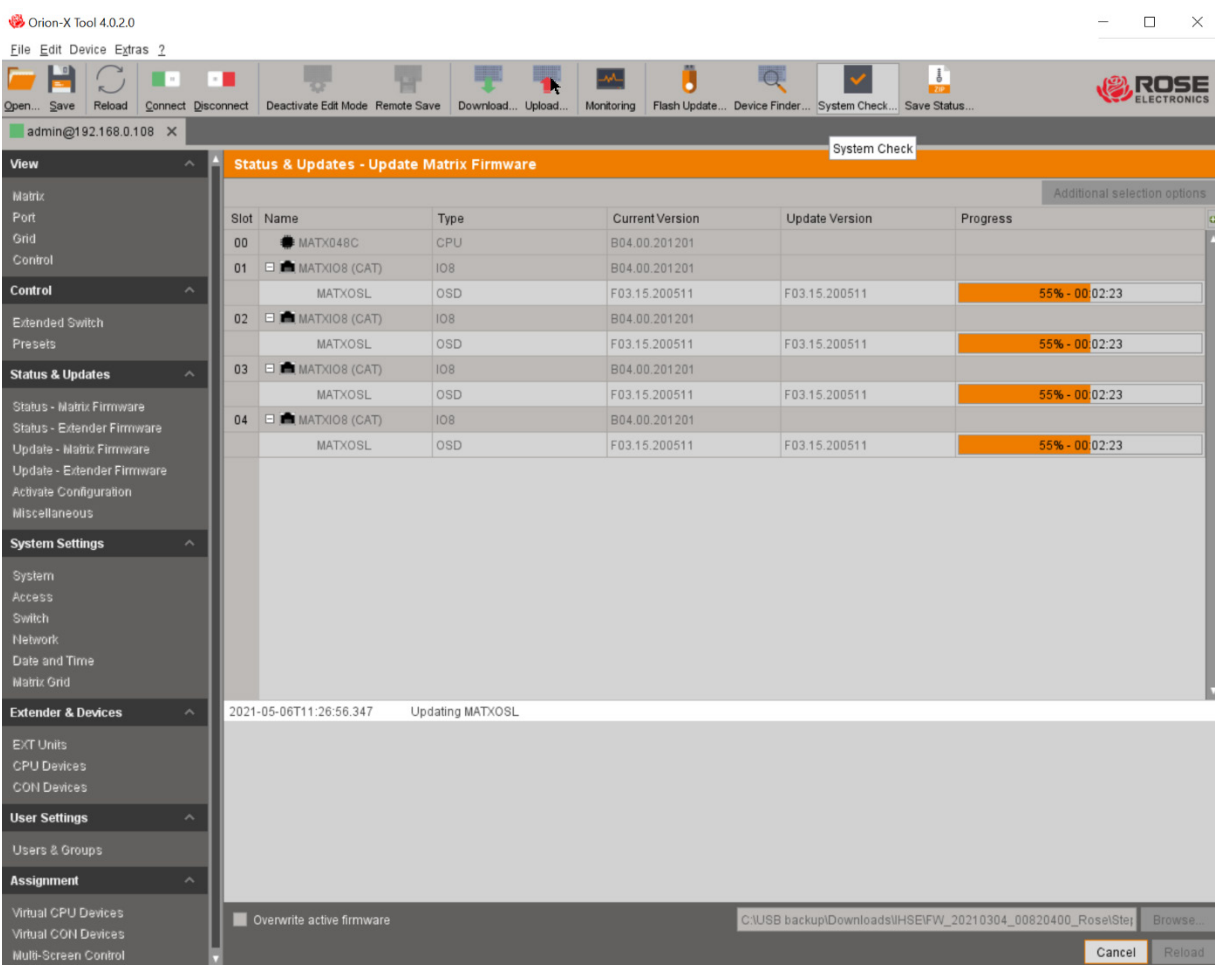

**Figure 168. Firmware Update Progress Indicator**

- After the update has completed, a prompt to restart the Orion FX is displayed. Click yes to restart the Matrix with the updated firmware.

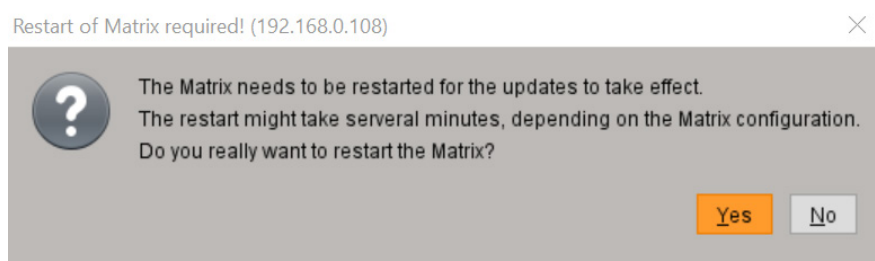

**Figure 169. Prompt to Restart the Matrix After Firmware Update**

- After the Orion FX has restarted, the outcome of the Update operation is indicated in the Java Tool.

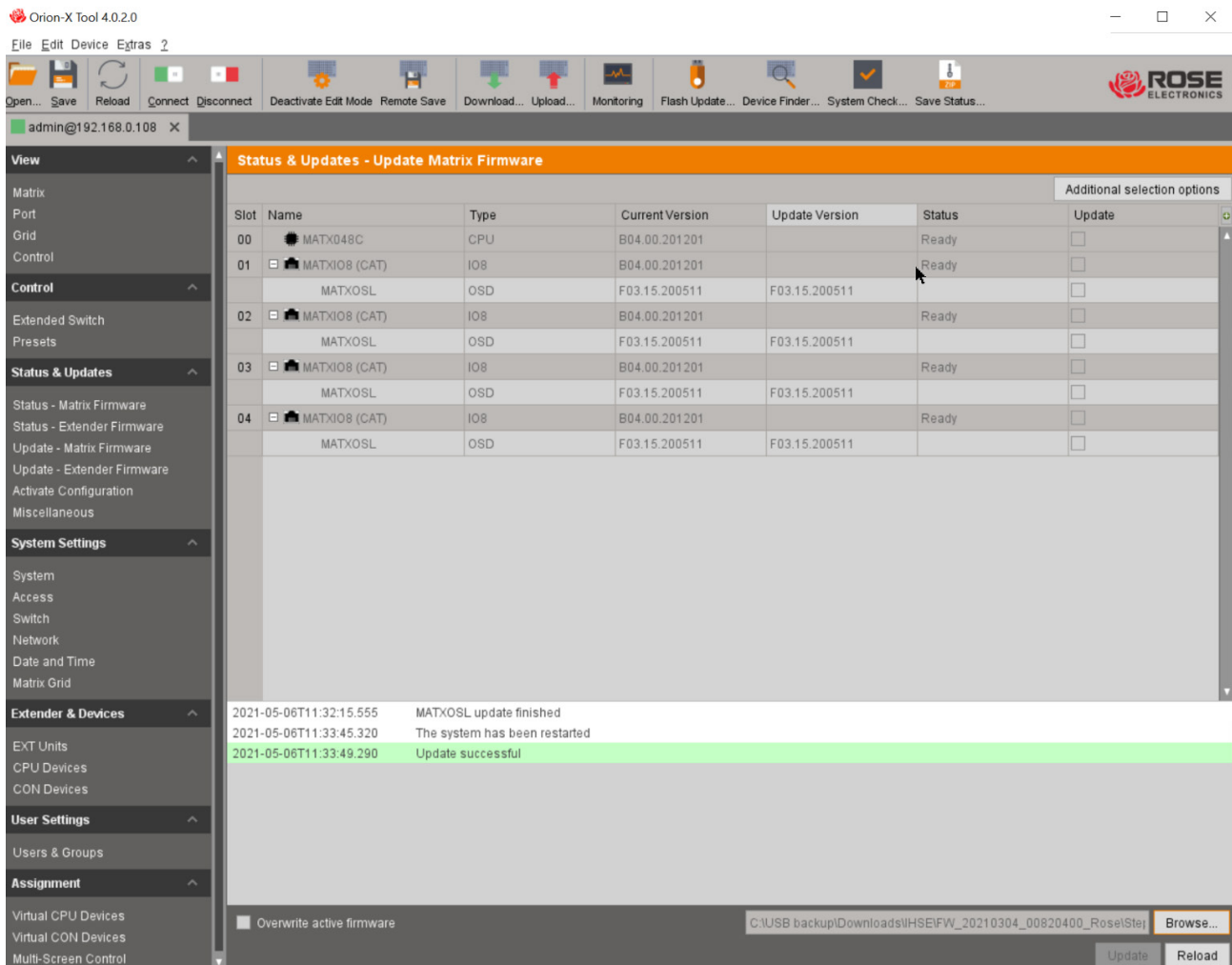

**Figure 170. Firmware Update Success**

## Extender Update

The firmware of the extenders connected to the matrix can be updated with the Java Tool, with the exception of firmware of type xxxMSD, which must be updated via mini-USB service port.

### Preparation

Take the following steps to prepare for the extender update:

1. Save the matrix configuration externally. (See [Saving of Configurations \(External\)](#)).
2. Open **Extras > Options** in the menu bar, and enter the path to the \*.efw firmware update files in the **Firmware Directory** setting. Click the **Ok** button to save the path setting.

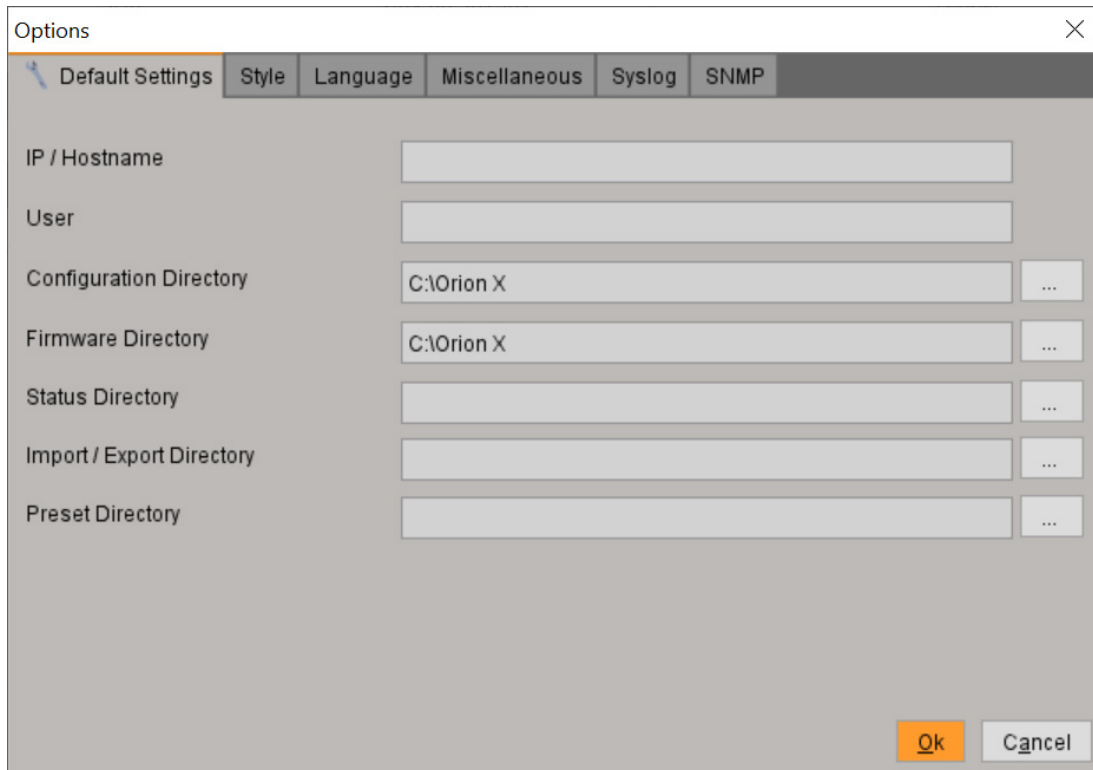

Figure 171. Firmware Directory in the Java Tool

3. Connect all spare extenders to the matrix.

**Note:** The extender update should be performed over a direct LAN connection, due to network stability issues.

## Performing the Update in Standard Mode (Parallel Update)

1. Select **Status & Updates > Update - Extender Firmware** in the task area. The standard mode for parallel update will be selected by default, and the **Step 1: Upload Firmware** tab will be selected.

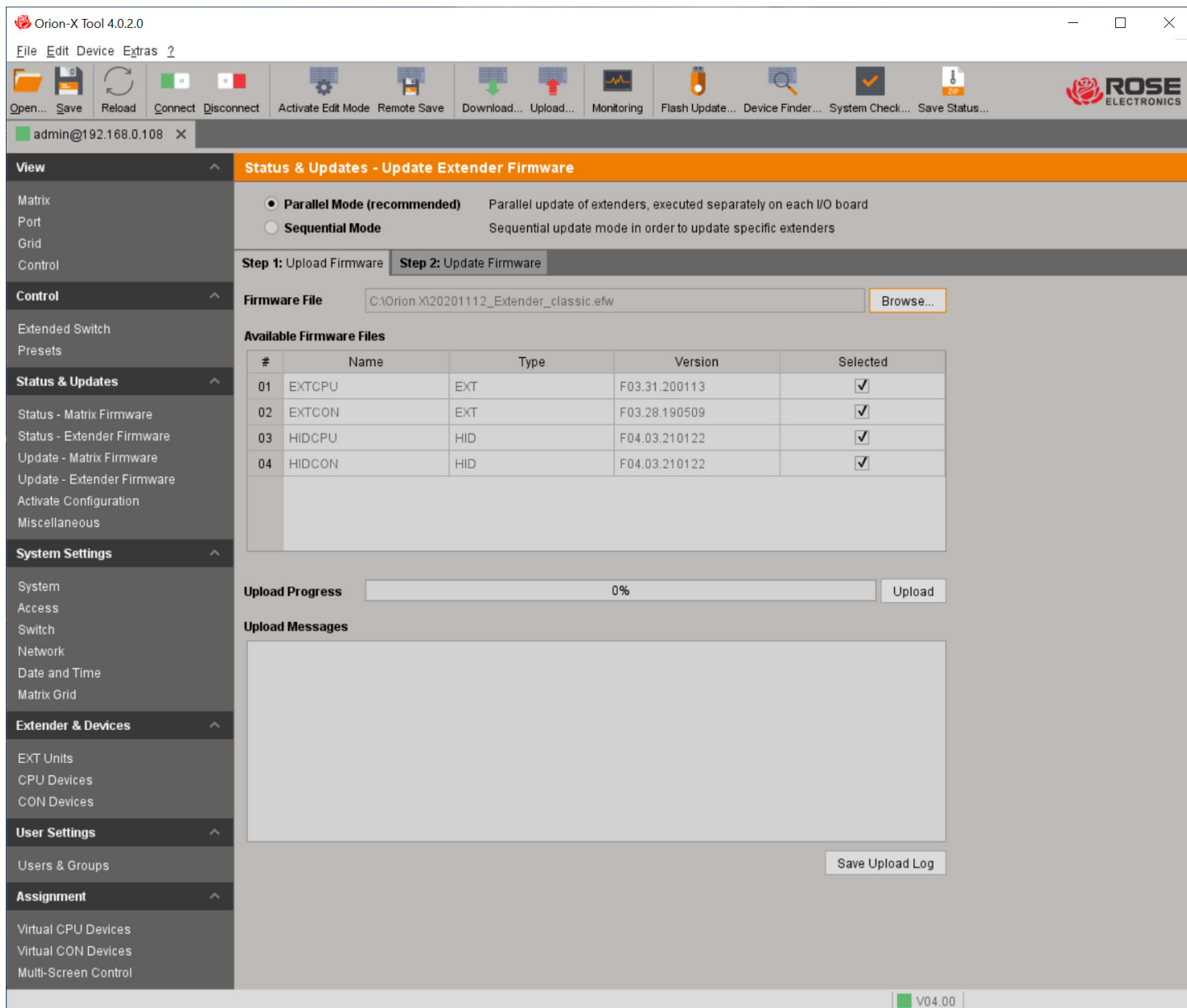

Figure 172. Extender Update in Standard Mode through the Java Tool - Step 1: Upload Firmware

2. Before the actual update process can begin, all firmware files have to be uploaded to the I/O boards of the extenders to be updated. If a newer firmware is available, the appropriate I/O boards will be automatically selected for upload in the **Selected** column and highlighted in green.

- Start the upload and distribution of the update files by clicking the **Upload** button. Uploading does not install the update files in the extenders, and the actual update can be performed at a later time.

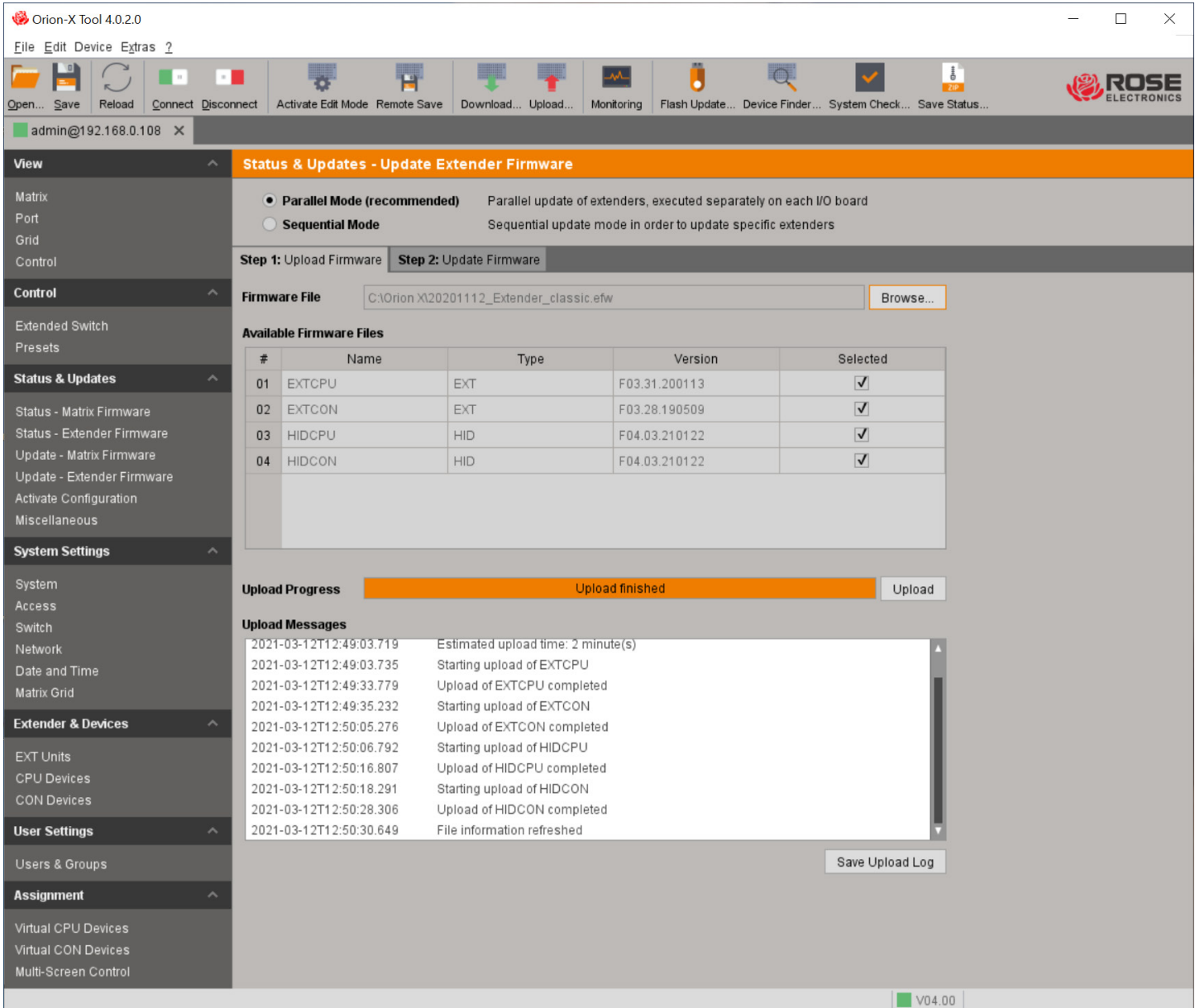

Figure 173. Upload Extender Firmware to I/O boards with Java Tool

- The successful completion of the upload process will be confirmed by a pop-up. Proceed to the actual update process by clicking the **Yes** button. The Java Tool will automatically open the **Step 2: Update Firmware** tab.

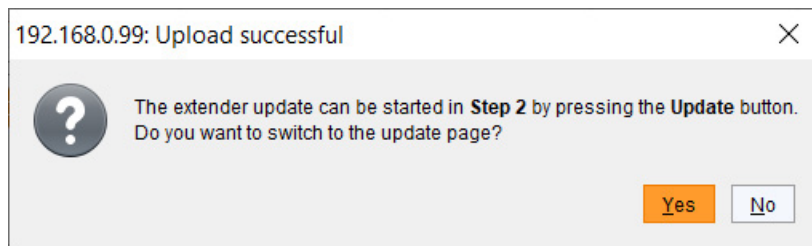

Figure 174. Extender Firmware Update Part 2 in the Java Tool

- To update with a firmware identical to or older than the version currently installed, click the **Enable Downgrade** option in the upper part of the Step2 working area.
- Start the actual update process by clicking the **Update** button.

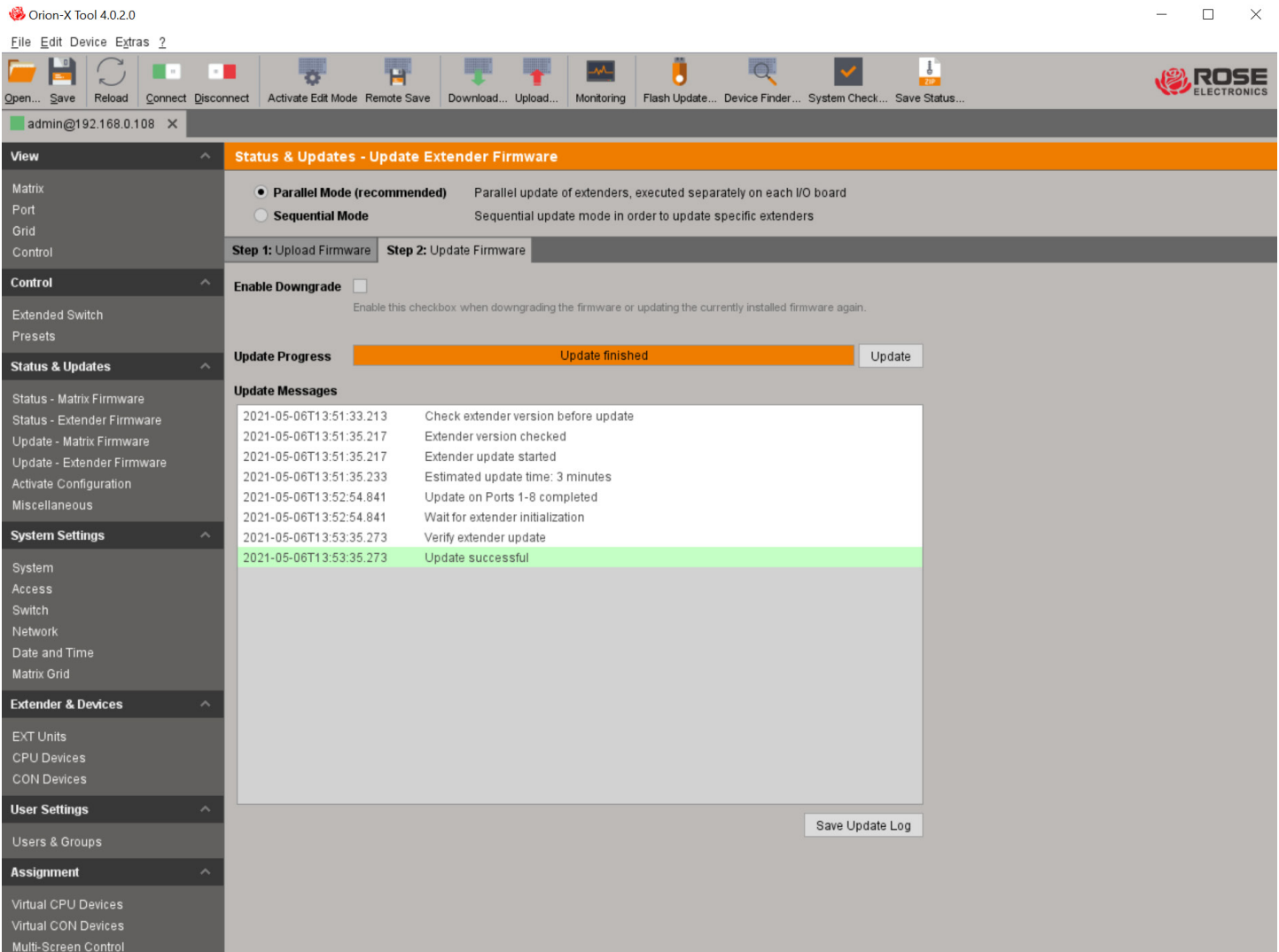

Figure 175. Enable Downgrade to Reload Current or Previous Firmware with the Java Tool

**Note:** Just before update begins, all affected I/O boards will be put into **Service Mode**. Each will be reactivated when its firmware update has completed.

## Performing the Update in Expert Mode (sequential Update)

Take the following steps to prepare for the extender update.

1. Select **Status & Updates > Update – Extender Firmware** and select **Sequential Mode** in the upper part of the working area. All extenders eligible for update will be automatically selected and highlighted in green.

Orion-X Tool 4.0.2.0

File Edit Device Extras ?

Open... Save Reload Connect Disconnect Activate Edit Mode Remote Save Download... Upload... Monitoring Flash Update... Device Finder... System Check... Save Status...

admin@192.168.0.108 X

**View** Status & Updates - Update Extender Firmware

Matrix  
Port  
Grid  
Control

Parallel Mode (recommended) Parallel update of extenders, executed separately on each I/O board

Sequential Mode Sequential update mode in order to update specific extenders

Additional selection options

#	ID	Name	Port	Type	Device	Current Version	Update Version	Update
01	10173373	EXT_CPU02	1	CPU UNIT	CPU_Computer-02			<input type="checkbox"/>
02	10173372	EXT_CPU01	3	CPU UNIT	CPU_Computer-01			<input type="checkbox"/>
03	10216759	EXT_CPU04	5	CPU UNIT	CPU_Computer-04			<input type="checkbox"/>
04	10173392	EXT_CPU03	7	CPU UNIT	CPU_Computer-03			<input type="checkbox"/>
05	10173401	EXT_CPU06	9	CPU UNIT	CPU_Computer-06			<input type="checkbox"/>
06	10157706	EXT_CPU05	11	CPU UNIT	CPU_Computer-05			<input type="checkbox"/>
07	10157576	EXT_PanelMount	13	CON UNIT	CON_PanelMount			<input type="checkbox"/>
08	10173315	EXT_QV Input1	15	CON UNIT	CON_QV input1			<input type="checkbox"/>
09	10173352	EXT_QV Input2	17	CON UNIT	CON_QV input2			<input type="checkbox"/>
10	10173347	EXT_QV Input3	19	CON UNIT	CON_QV input3			<input type="checkbox"/>
11	10173266	EXT_QV Input4	21	CON UNIT	CON_QV input4			<input type="checkbox"/>
12	10173282	EXT_CSKVT20	23	CON UNIT	CON_CSKVT20			<input type="checkbox"/>
13	10173269	EXT_LCD20	25	CON UNIT	CON_LCD20			<input type="checkbox"/>
14	10154890	EXT_QVOUTPUT	27	CPU UNIT	CPU_QV-Output			<input type="checkbox"/>

System Settings

System  
Access  
Switch  
Network  
Date and Time  
Matrix Grid

Extender & Devices

EXT Units  
CPU Devices  
CON Devices

User Settings

Users & Groups

Assignment

- Extender firmware version conflict
- Manual update of EXTMSD / EXTMSD recommended
- Wrong module type (CPU/CON mismatch)
- Undefined type

C:\Orion X\20201112\_Extender\_classic.fw Browse...

Update Reload

V04.00

Figure 176. Extender Update in Sequential Mode – Step 1 (from the Java Tool)

- Put the Orion FX into Service Mode upon request in the pop-up window or through **Device > Advanced Service > Activate Service Mode** in the menu bar.

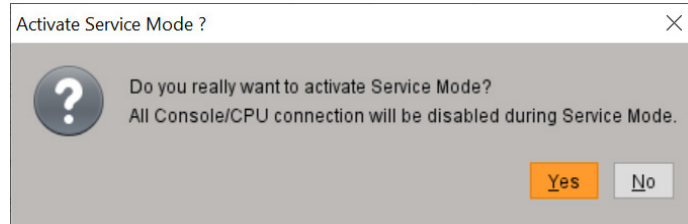

Figure 177. Activate Service Mode with the Java Tool

**Note:** During Service Mode, all matrix functions are disabled on the I/O boards on which updates are being performed. An OSD notice indicating that the I/O boards were placed in Service Mode is displayed on all monitors connected to the matrix through a CON device. Additionally, the Service Mode is indicated by a red tool icon in the lower part of the working area of the Java Tool.

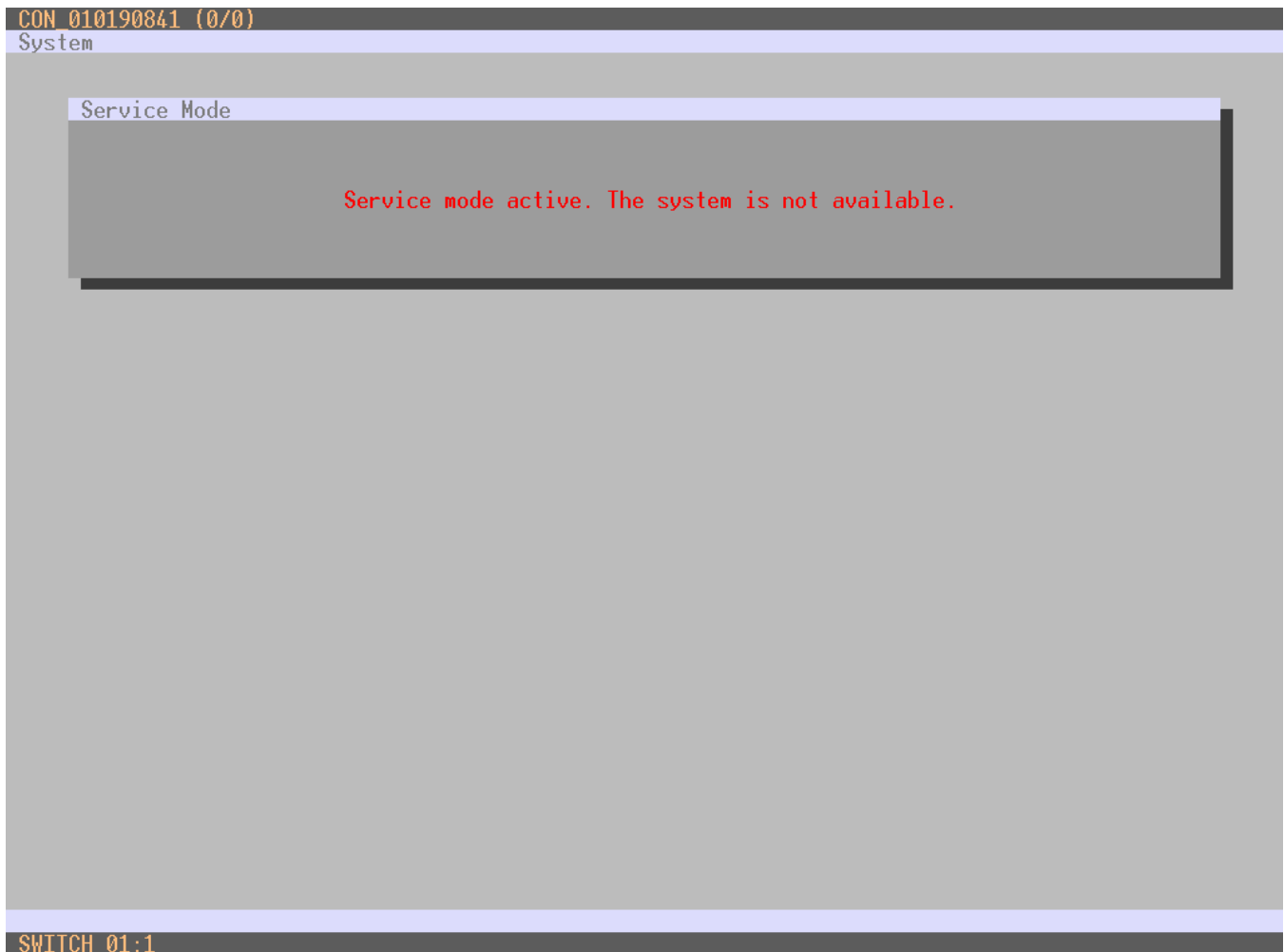

Figure 178. OSD View Service Mode – Step 2 (from the Service Mode of the OSD)

- Start the update by clicking the **Update** button in the lower part of the working area.
- Exit Service Mode after updating by responding to the confirmation request in the pop-up window or through **Device > Advanced Service > Deactivate Service Mode** in the task area.
- After the update, verify through the Java Tool that the updates for all extenders have been installed correctly. This is done in **Status & Updates > Update – Extender Firmware**.

## Operation

---

The Orion FX can be operated in three different ways:

1. Direct Switching through a keyboard connected to a CON port
  - using 'Hot Keys' to switch between as many as 16 favorites
  - using 'Hot Keys' to invoke switching macros
2. OSD Switching using 'Hot Keys' to display the OSD and then selecting from the entire range of CPUs the console or user can access
  - through a keyboard connected to a CON port
3. External Switching Commands
  - from an external computer running the Java Tool (network connection required)

### Switching Operation via Keyboard Commands

Several operations on the Orion FX can be performed using the 'Hot Keys' at a console keyboard, as described below.

#### *Direct Switching*

Direct switching by 'Hot Keys' on a keyboard is the quickest way for a user to switch a console between different CPUs in their favorites list. It is possible to switch video, keyboard and mouse together, or just the video.

#### Direct Switching of Video, Keyboard and Mouse

1. Start Command Mode with the 'Hot Key' sequence. The **Caps Lock** and **Scroll Lock** keyboard LEDs will flash repeatedly when Command Mode is activated.
2. Enter the index number of the new CPU from the list of favorites and confirm with <Enter>. Command Mode is closed and the console is connected to the new CPU with complete control.  
Example: Switch video, keyboard and mouse to number 7 in the favorites list using the default hot key <left Shift>, <left Shift>, <7>, <Enter>

**Note:** The fastest switching will be achieved when identical mice, keyboards and monitors are used at all consoles. This contributes to a smooth and seamless direct switching of the matrix.

#### Direct Switching of Video, Keyboard and Mouse in Private Mode

1. Start Command Mode with the 'Hot Key' sequence. The **Caps Lock** and **Scroll Lock** keyboard LEDs will flash repeatedly when Command Mode is activated.
2. Enter the index number of the new CPU from the list of favorites and confirm by pressing the <left Shift>+<Enter> keys at the same time. Command Mode is closed and the console is connected to the new CPU with complete control in **Private Mode**.  
Example: Switch video, keyboard and mouse to number 3 in the favorites list in **Private Mode** using the default hot key <'left Shift'>, <'left Shift'>, <3>, <left Shift>+<Enter>

## Direct Switching of Video Only

1. Start Command Mode with the 'Hot Key' sequence. The **Caps Lock** and **Scroll Lock** keyboard LEDs will flash repeatedly when Command Mode is activated.
2. Enter the index number of the new CPU from the list of favorites and confirm with <Space>. Command Mode is closed and the console is connected to the new CPU with video only. Example: Switching to number 1 in the favorites list with video only using default hot key <left Shift>, <left Shift>, <1>, <Space>

## Direct Switching of Video, Keyboard and Mouse to previous CPU

1. Start Command Mode with the 'Hot Key'. The **Caps Lock** and **Scroll Lock** keyboard LEDs will flash repeatedly when Command Mode is activated.
2. Press the <p> key on the keyboard. Command Mode is closed and the console is connected to the previous CPU with complete control.

### **Note:**

- If the console is switched to a CPU that was previously connected with Video Only Access, it will now be connected to this CPU with full KVM access.
- When using 'Hot Keys' for direct switching, the user may only be able to connect to unused CPUs to which access is permitted. The **Force Connect** and **Force Disconnect** options, as well as the restrictions of the User ACL and CON ACL are taken into account.
- 'Hot Keys' switching is only supported if the User is logged in, or if neither **Enable User Login** nor **Enable User ACL** is selected.

## Disconnect current connection

1. Start Command Mode with the 'Hot Key' sequence. The **Caps Lock** and **Scroll Lock** keyboard LEDs will flash repeatedly when Command Mode is activated.
2. Press the <Backspace> key on the keyboard. Command Mode is closed and the console is disconnected from the currently connected CPU.

## *Scan Mode*

Scan Mode enables fast switching between video inputs from different CPUs in the favorites list without continuously using the 'Hot Key'. The switching between two video signals can even take place within one frame.

1. Start command mode with the 'Hot Key'. The **Caps Lock** and **Scroll Lock** keyboard LEDs will flash repeatedly when Command Mode is activated.
2. Press the <Left Shift> key and hold it down. The index numbers of CPUs from the list of favorites can be entered on the keyboard, causing the matrix to switch immediately to the video signal of the specified CPU.
3. Leave Scan Mode by pressing <Left Shift> + <Esc>.

**Note:** Optimal scan mode results can be achieved by the use of display resolutions as close to identical as possible. This contributes to a smooth and seamless switching in scan mode.

## *Function Keys <F1>-<F16>*

In Command Mode, macros 1-16 can be invoked with the function keys <F1>-<F16> of the connected keyboard. Macros 17-32 are invoked by simultaneously holding the key <Left Shift> while typing the keys <F1>-<F16>. The stored command sequence for the appropriate function key is executed and Command Mode is closed. It is not necessary to press <Enter> to confirm selection of macros.

## Switching a CON Unit to a local Source

CON Units connected to a local source can be locally switched by keyboard commands or the OSD.

The following keyboard commands allow switching to the local source:

Function	Keyboard Command
Switching to extender connection 1	<'Hot Key'>, <k>, <1>, <Enter>
Switching to extender connection 2 (only with redundant CON Units)	<'Hot Key'>, <k>, <2>, <Enter>
Switching to the local source (computer, CPU)	<'Hot Key'>, <l>, <Enter>

**Table 60. Keyboard Commands for Local Source Switching**

## Multi-Screen Control

The Multi-Screen function allows a CON Device with several assigned monitors to switch keyboard and mouse between several CPU sources by either moving the mouse pointer beyond the edge of the current monitor, or by keyboard command. Configuring CON Devices for Multi-screen control is described in the Configuration section, Console Device Settings, [Multi-Screen Control](#).

### Switching through the mouse

Switching the USB-HID devices can be done by moving the mouse pointer beyond the edge of the current display. In order to perform a switching operation by moving the mouse, proceed as follows.

1. Move the mouse pointer to the vertical or horizontal edge of the display that borders a neighboring display in the CON Device.
2. Move the mouse pointer beyond the edge of the display. USB HID switching will occur to the CPU displayed on the neighboring monitor. The mouse pointer will appear on the adjacent display, and any other console USB-HID devices (e.g. keyboard) will also be available at the CPU device displayed on that monitor.

### Switching through the keyboard

Switching the USB-HID devices can also be done using the keyboard. In order to perform a switching operation via keyboard command, proceed as follows.

1. Start Command Mode with the 'Hot Key'.
2. Select the target display by pressing the appropriate key on the numeric pad of the keyboard.

The switching operation will be performed and the USB-HID devices will be available at the CPU connected to the target display.

The keyboard commands to switch to each display's CPU connection are given the table below.

Keyboard Command	Function
<'Hot Key'>, <Num 0>	Switch the USB-HID signal to the own display (CON Unit with keyboard and mouse)
<'Hot Key'>, <Num 1>	Switch the USB-HID devices to the CPU connected to display #1
<'Hot Key'>, <Num 2>	Switch the USB-HID devices to the CPU connected to display #2
<'Hot Key'>, <Num 3>	Switch the USB-HID devices to the CPU connected to display #3
<'Hot Key'>, <Num 4>	Switch the USB-HID devices to the CPU connected to display #4

**Table 61. Keyboard Commands for Multi-Screen Switching**

## Switching Operation through the OSD

### *KVM Switching*

KVM Switching can be performed through the OSD.

→ Display the OSD main menu and select **Switch**.

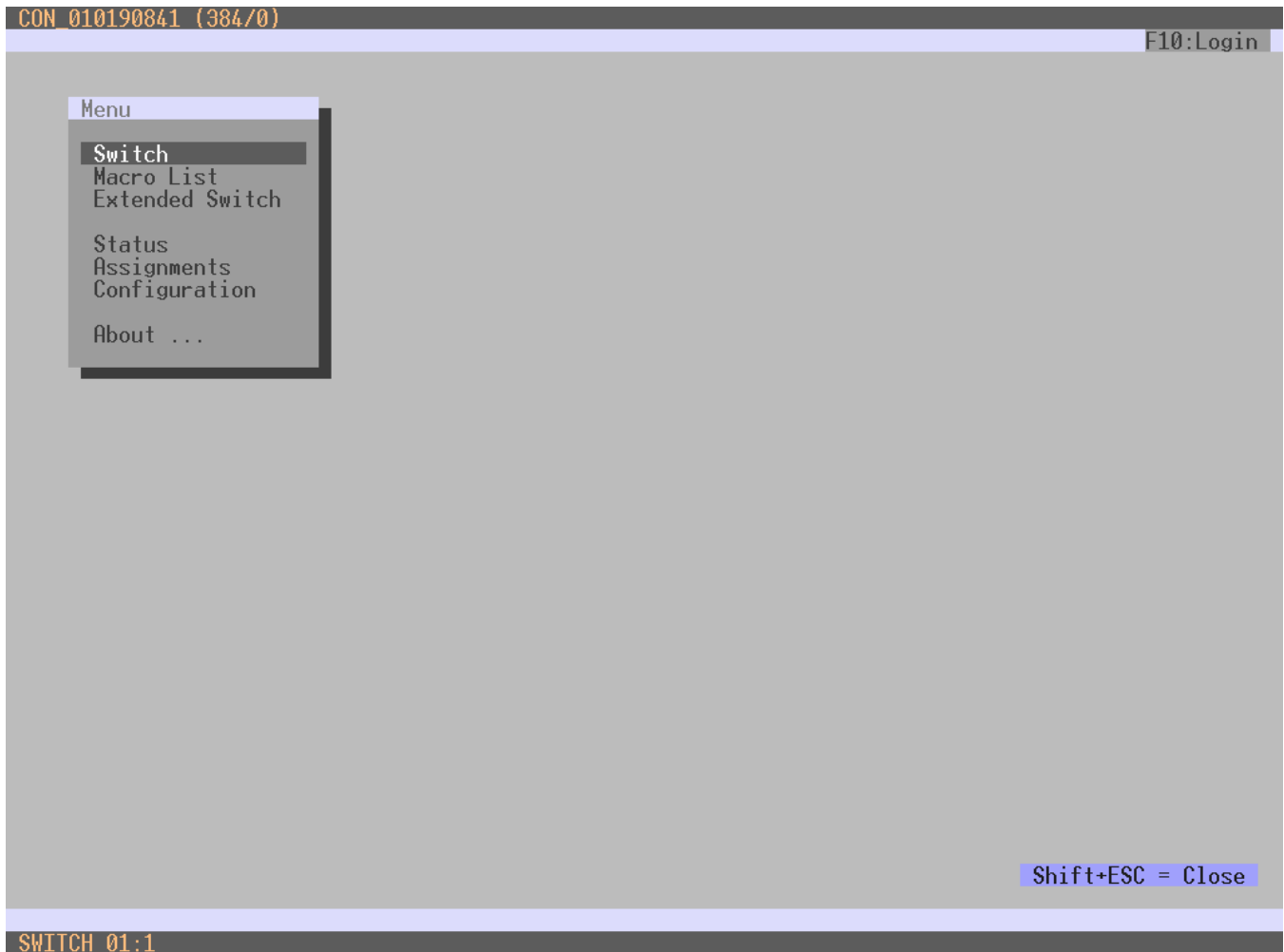

Figure 179. Main Menu of the OSD

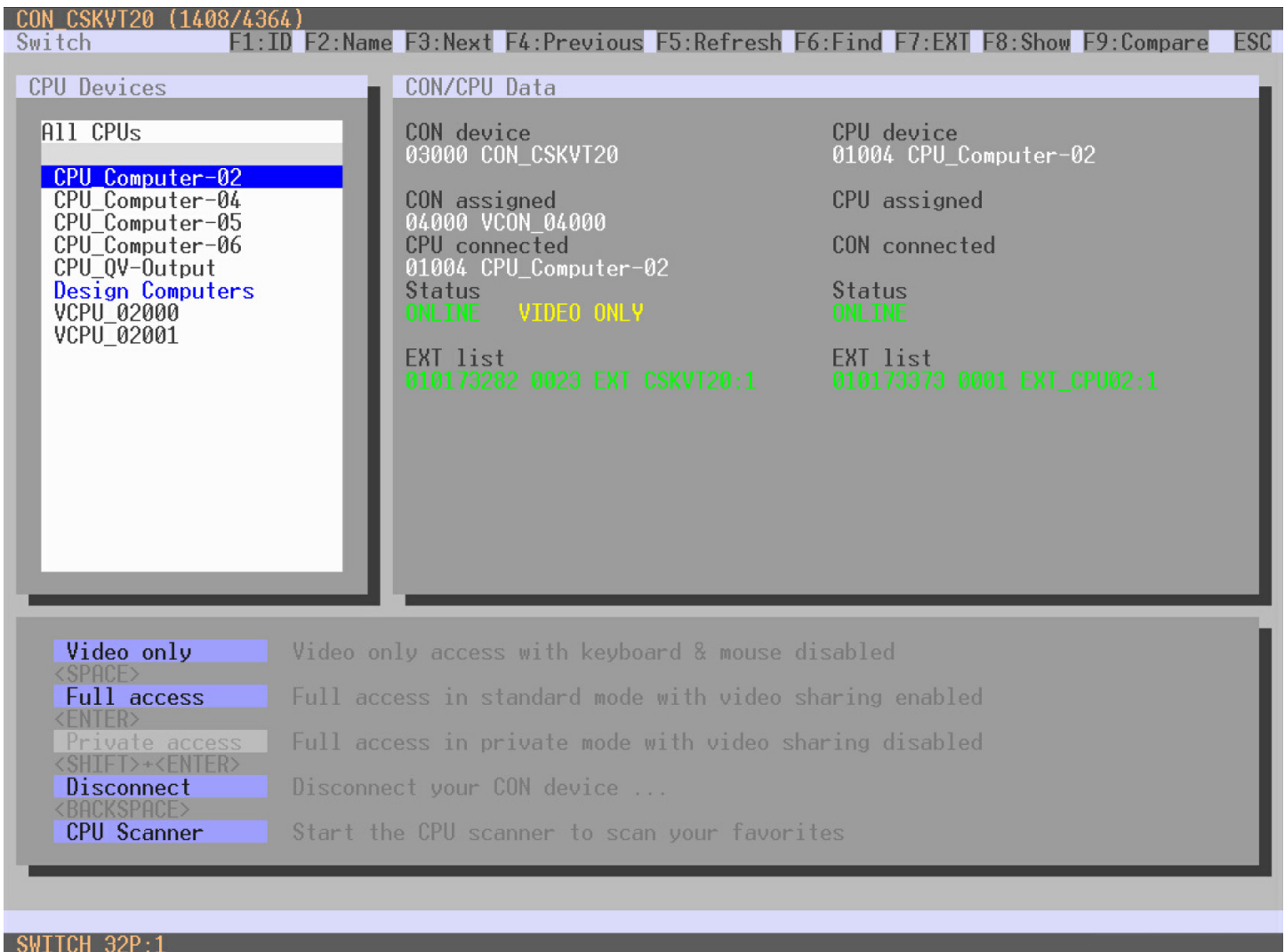

Figure 180. KVM Switching Through the OSD

To switch the console to an available CPU, proceed as follows:

1. Select a CPU device from the **CPU Devices** list on the left side to connect to the CON device. Press the <F8> key to expand the list to show inactive CPU Devices.
2. Confirm the desired connection type with the appropriate keystroke: <Space> for video only, <Enter> for full KVM access, and <Shift>+<Enter> for a private connection.

Switching operations by a CON device can only be made to the devices in the **CPU Devices** list.

**Note:** Listed CPU Devices highlighted in red are currently connected in Private Mode and are blocked by the currently connected CON Device.

## Switching using the Selection List for CPU Devices

It is also possible to switch CPU devices by means of a second selection list which can be displayed whenever the OSD is activated at a console.

In order to use the selection list for CPU Devices, proceed as follows.

1. In the OSD Main Menu, select **Configuration** and log in.
2. Select **EXT Units** and activate the **Enable CPU Selection** option in the menu for each console where the selection list for CPU Devices should be displayed.
3. Execute the key sequence for opening the OSD. The selection list immediately appears in the preset position of the extender OSD.  
**Note:** Pressing <F8> shows inactive CPU Devices for a more complete list.
4. Select a CPU, and complete the switching operation by pressing the key which corresponds to the kind of connection desired.

Function	Keyboard Command
Make a video only connection	<Space>
Make a full KVM connection	<Enter>
Make a full KVM connection in private mode	<Shift> + <Enter>
Disconnect from current CPU connection	<Backspace>

Table 62. Keyboard Commands for Connecting and Disconnecting in the OSD

To move to the Main OSD menu when the Selection List is displayed, press <F7>. To close the selection list, press <Esc>.

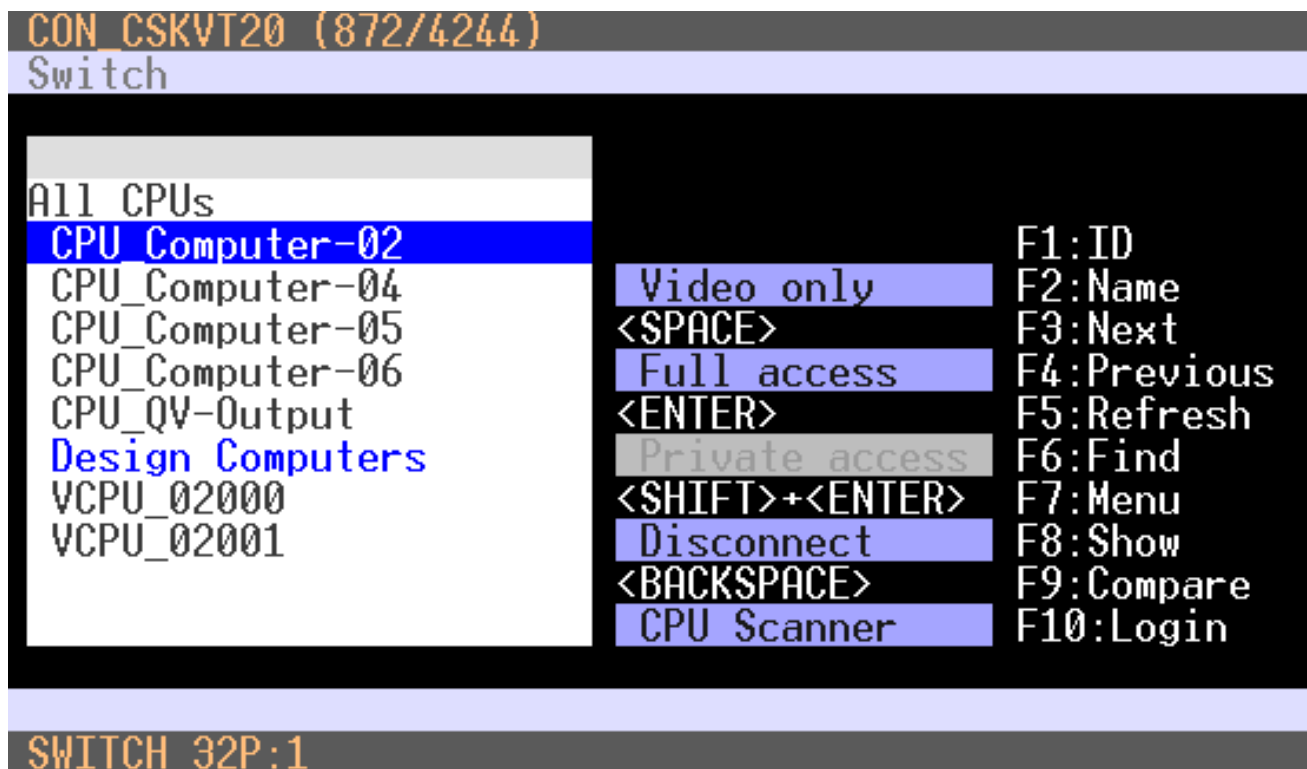

Figure 181. CPU Selection List in the OSD for KVM Switching

## Activating automatic Scan Mode for CPU Devices

The matrix offers an automatic scan mode based on the favorites list of each console or user. Scan mode allows the matrix to switch sequentially between the CPU Devices in the favorites list at a specified time interval. Automatic scan mode operates in video only mode. Scan Mode configuration was described in the Configuration section (see [CON Devices](#)). Scan Mode is activated through from the OSD.

To activate scan mode, proceed as follows.

1. Create a favorites list for a CON Device or User (see [Console Favorites List](#) or [User Favorites List](#)).
2. Start Command Mode with the 'Hot Key' and press <o> to open the OSD.
3. Select one of the CPU Devices in the CPU selection list that is defined in the favorites list.
4. Confirm the CPU Device selection by clicking the **CPU Scanner** button. The scan will automatically start.
5. If the **Force CPU Scan** option is enabled, the scan will automatically start after switching the CON Device to any CPU Device in the favorites list without the need to press the **CPU Scanner** button.

### Extended Switching

Extended switching allows other consoles to be switched to any CPU, subject to access control. It can be performed through the OSD or the Java Tool.

To switch any console to any available CPU through the OSD, proceed as follows:

➔ Select **Switch** in the main menu.

**Note:** Pressing <F8> shows inactive CPU Devices for a more complete view.

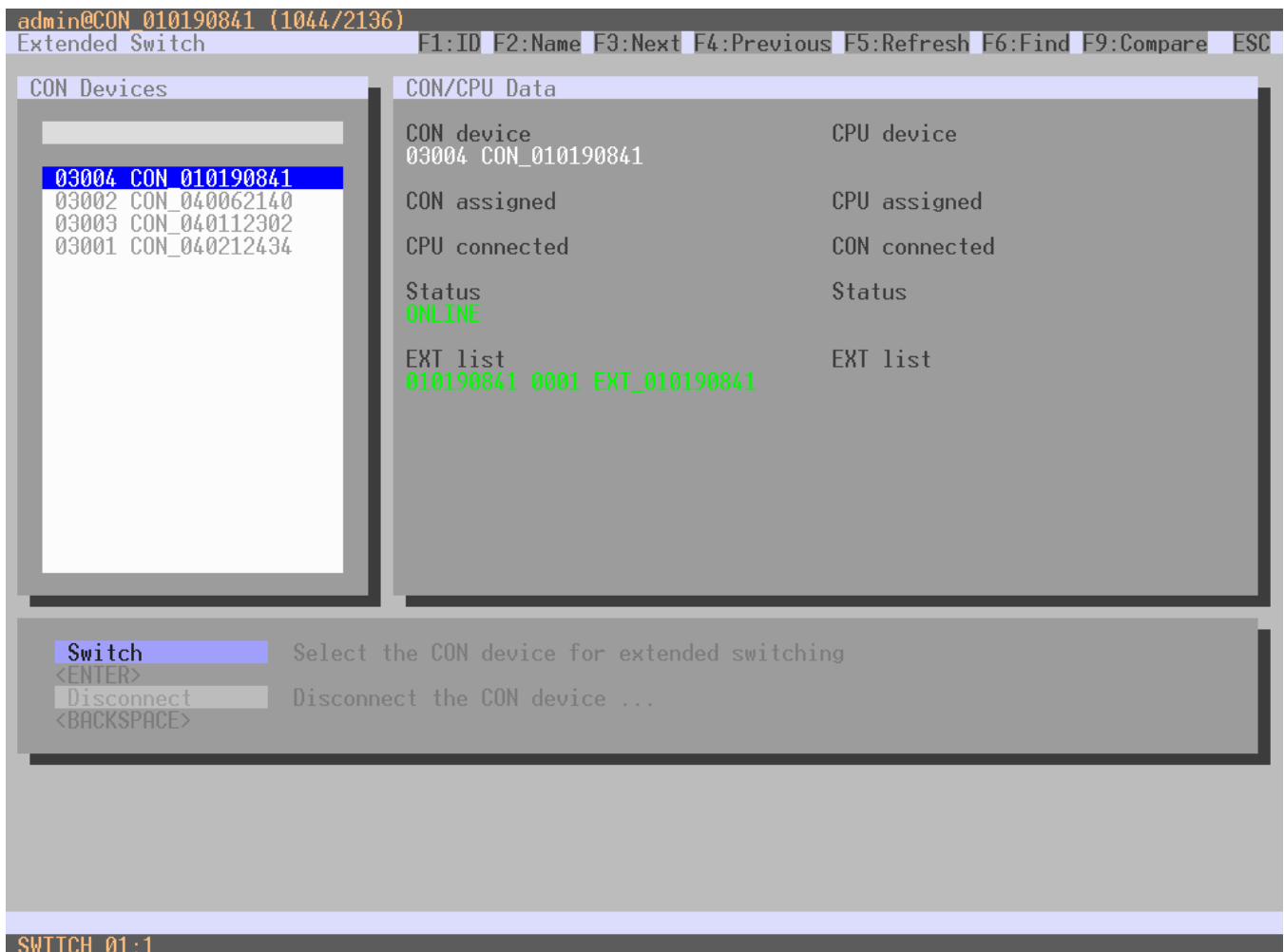

Figure 182. Extended KVM Switching through the OSD

1. Select a CON device from the **CON Devices** list on the left side to be switched to a CPU device, and open it by pressing <Enter>.
2. Now select a CPU device from the **CPU Devices** list on the left side to be connected to the open CON device.
3. Select the desired connection type with the appropriate keyboard command, as listed in Table 62 above.

A given CON device can only be switched to a CPU device that is shown as available in **CPU Devices** list. The following information is shown in this menu:

Field	Description
<b>CON device</b>	Assigned physical extender unit (CON unit)
<b>CON assigned</b>	Virtual CON Device that is assigned to the real CON device
<b>CPU connected</b>	Currently connected CPU device
<b>CON status</b>	Current connection status (CON device)
<b>EXT list</b>	List of all available physical extender units (CON units)
<b>CPU device</b>	Assigned physical extender unit (CPU unit)
<b>CPU assigned</b>	Real CPU device that is assigned to a virtual CPU device
<b>CON connected</b>	Currently connected CON device
<b>CPU status</b>	Current connection status (CPU device)
<b>EXT list</b>	List of all available physical extender units (CPU units)

**Table 63. Extended KVM Switch Settings in the OSD**

### *USB 2.0 Switching*

Switching of USB 2.0 extenders works like the switching of KVM extenders. There are two options for switching USB 2.0 extenders depending on how the extenders are configured in the Matrix.

1. An extender unit with USB 2.0 is created and assigned to an existing device which has KVM extender units.
2. A separate device is created for the extender unit with USB 2.0 which has no KVM extender units assigned to it. This allows switching of USB 2.0 devices independently from KVM devices.

#### **Note:**

- Switching of USB 2.0 signals uses Extended Switching functionality as described earlier in this section.
- When using parallel operation within the matrix, set the Release Time in the **System Settings > Switch** menu to 10 s or more (see [Shared Operation](#)). Otherwise, the USB 2.0 extender connection will not be established for reasons of security and stability.

## Switching a CON Unit to a Local Source with the OSD

CON Units connected to a local source (computer, CPU) can be switched with the matrix. Switching to the local source causes any matrix KVM connection to be automatically disconnected.

In order to switch to a local source, proceed as follows:

→ Display the OSD **Main** Menu and select **Switch**.

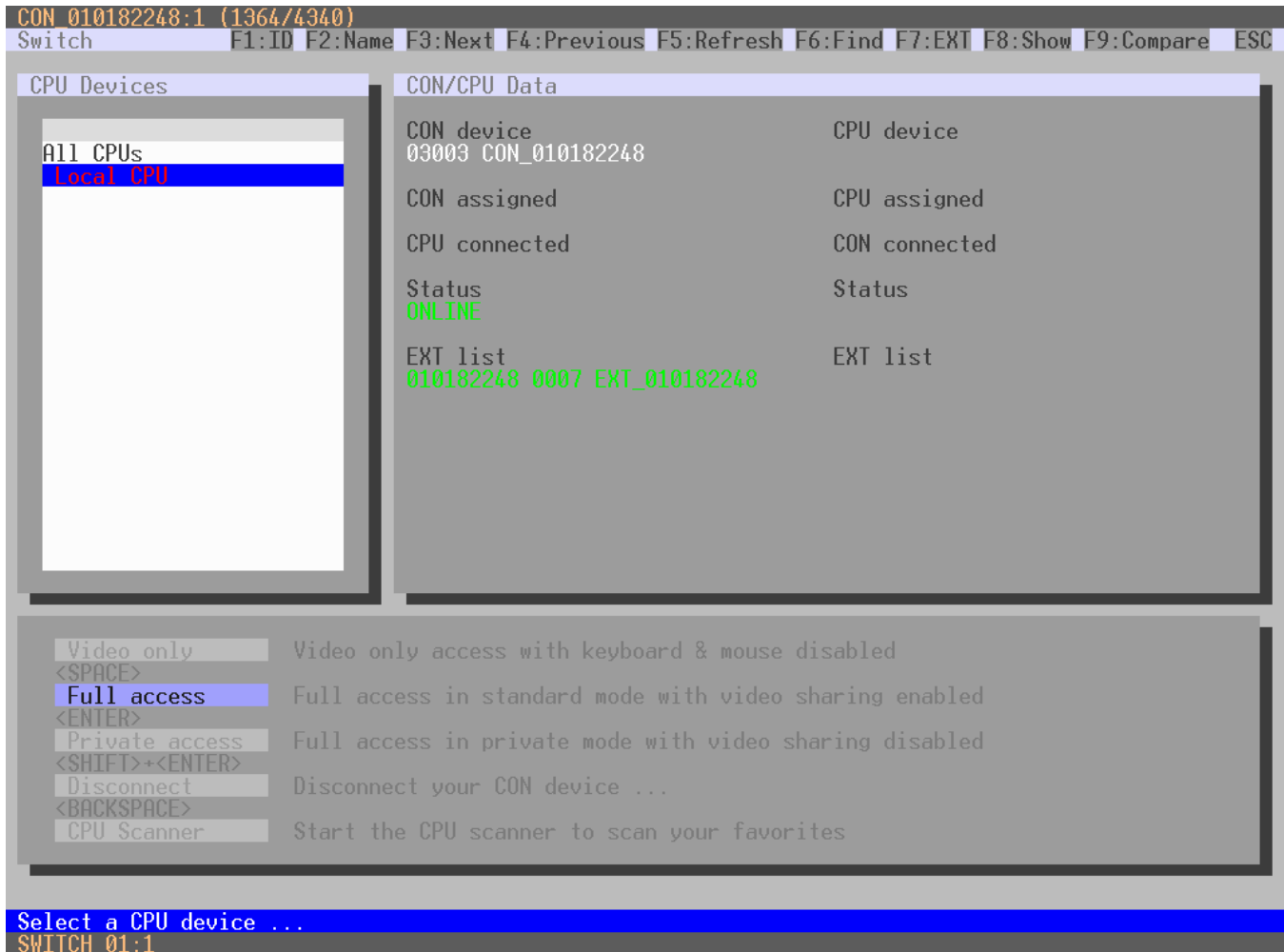

Figure 183. CON Switching Through the OSD

1. If not in the **Switch** menu of the OSD, start Command Mode with the 'Hot Key'.
2. Press <o> to open the OSD. This shows a list of all available CPUs as a start menu.
3. Select **Local CPU** in the list and switch to it. The switching operation to the local source will be performed immediately.

### Note:

- The local source (computer, CPU) will only be shown in the OSD if the CON Unit includes the option for a local connection.
- When CON Units that can connect to a local source (computer, CPU) are used in a Multi-Screen Control environment, switching to the local source is disabled.

## Switching via Macro List

In addition to invoking macros with their assigned function keys (<F1> to <F16> and <Lshift-F1> to <Lshift-F16>), macros can also be executed via Macro List in the OSD. The Macro List also allows the user to view the content of macros before executing them. Sixteen macros of the 32 possible are displayed on a page.

In order to switch to a local source, proceed as follows:

➔ Select **Macro List** in the main menu.

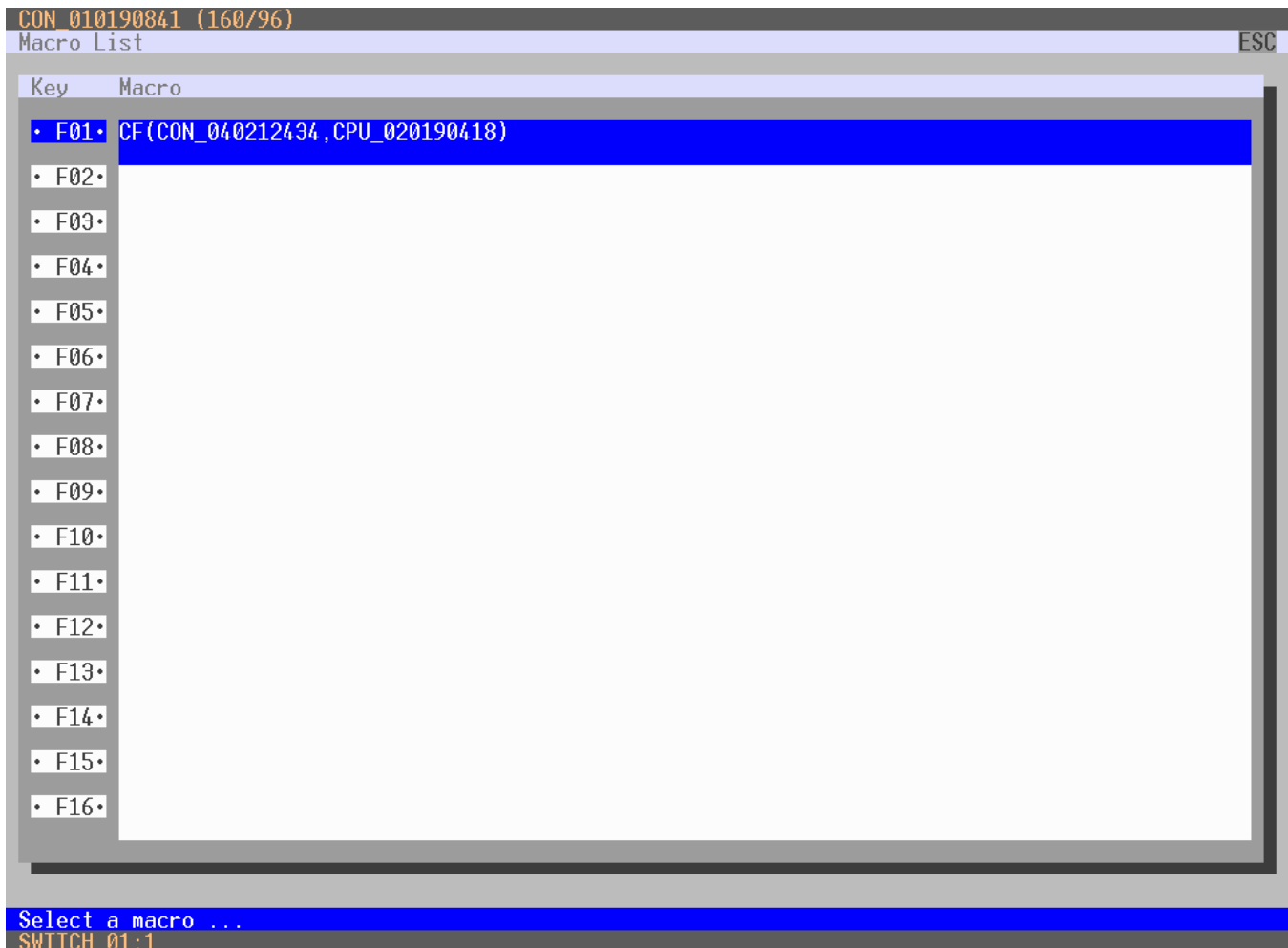

Figure 184. Switching via Macro List in the OSD

1. Make sure either CON or user macros have been defined.
2. Select one of the first 16 macros to be executed. Or press <Page Down> to select from macros 17 – 32.
3. Execute the macro by pressing the key <Enter>.

**Note:** To have the Macro List displayed each time the OSD is invoked, activate the option **Show Macro List** in the menu **Configuration > CON Devices** for the appropriate CON Devices.

## Switching Single EXT Units within Devices through the OSD

Individual extenders within multi-extender CON and CPU devices can be switched independently of the other extenders. This type of switching is done through the OSD.

To switch a single extender in a device which has multiple extenders, proceed as follows:

→ Display the OSD **Main Menu** and select **Switch**.

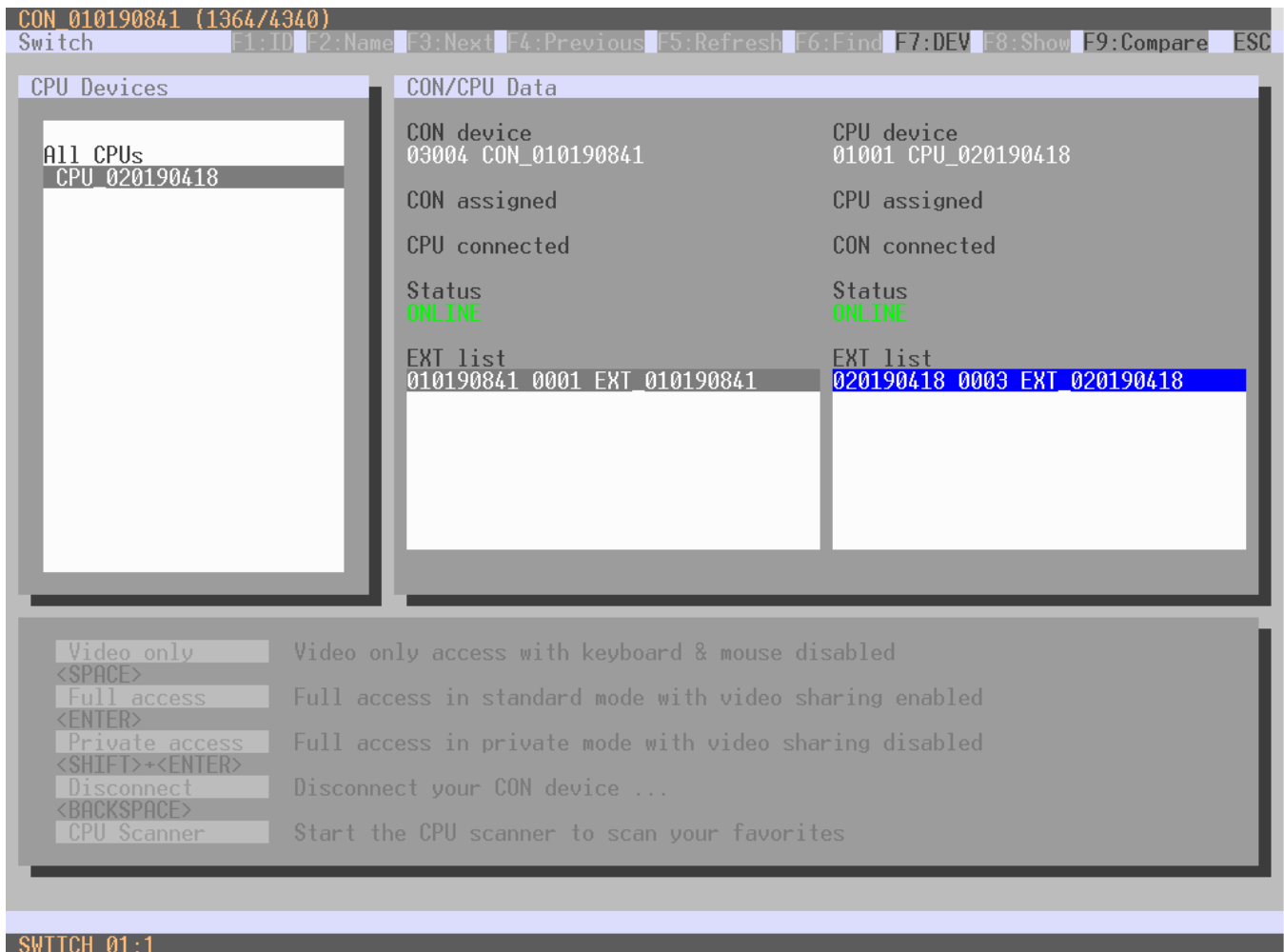

Figure 185. Switching of Single Extenders within Devices in the OSD

1. Select the CPU Device in the list which contains the extender to be accessed.
2. Press the function key <F7> on the keyboard. The mode will change to single extender switching.
3. Select the extender to switch in the CON device EXT list.
4. Press the <Tab> key to move to the CPU device EXT list.
5. Select the CPU extender to connect to and press the <Space> key to execute switching.

**Note:** Switching of single extenders within a Device is only possible in video only mode. Single extenders within a device that are already connected will be indicated with “!”.

## Addressing of Master and Sub Matrices

The Orion FX can be cascaded over two levels. Commands (including displaying the OSD) can be sent to either the master or the sub matrix.

When command mode is active, an extra keystroke can indicate whether the command should be handled by the main matrix or the sub matrix.

- Display the main matrix OSD:  
    <'Hot Key'>, <'Hot Key'>, <m> (optional), <o>
- Display the sub matrix OSD:  
    <'Hot Key'>, <'Hot Key'>, <s>, <o>

In order to perform cross-matrix switching, proceed as follows.

1. Open the OSD of the master matrix with the following keyboard sequence:
2. <'Hot Key'>, <o>
3. Select the CPU device configured as a Tie Line in the CPU selection list and press <Enter> to switch to it.
4. Open the OSD of the sub matrix with the following keyboard command:
5. <'Hot Key'>, <s>, <o>
6. Select the target CPU in the CPU selection list of the sub matrix and press <Enter> to switch to it.

**Note:** The selected main matrix / sub matrix mode will remain activated unless some other mode is manually activated, or Command Mode is exited. This means that if <s> is currently selected for example, all subsequent commands will be sent to the slave for as long as Command Mode remains active.

# Switching Operation through the Java Tool

## Extended Switching

There are two methods to perform switching operations in the Orion FX via the Java Tool.

### Method 1:

➔ Select **Control > Extended Switch** in the task area.

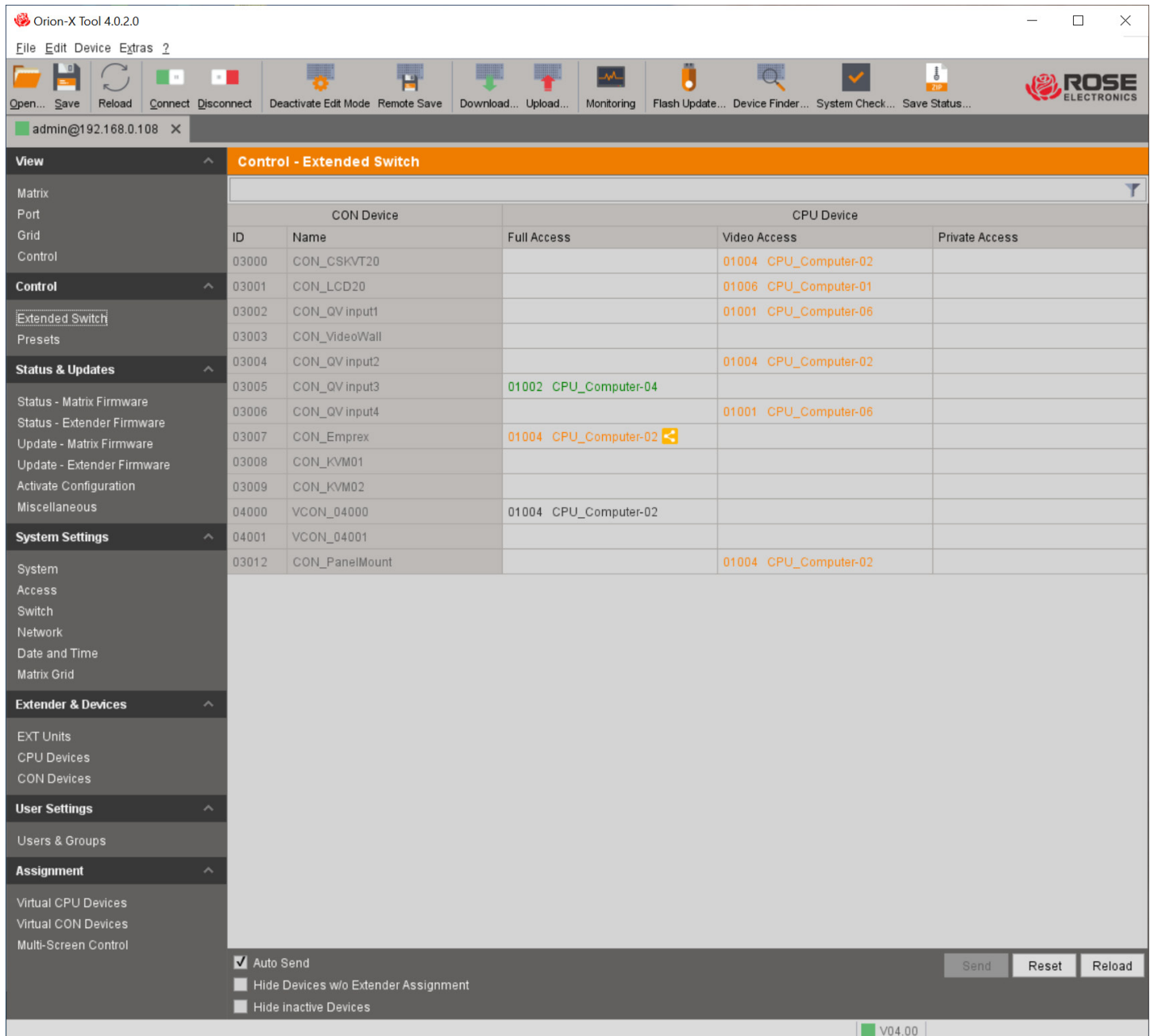

Figure 186. Extended KVM Switching through Java Tool - Method 1 (From Extended Switch)

All consoles and their CPU connections are shown in columns in the working area in this screen.

Extended switching operations can only be performed in Edit mode, that is, when there is an active network connection between the matrix and the Java Tool, and Edit mode has been activated by clicking the icon in the Tool Bar or selecting the option in the Device menu.

➔ To make a **KVM connection** between a console and a CPU, select the console, double-click on the corresponding selection box in the **Full Access** column, and select the desired CPU from the drop-down list.

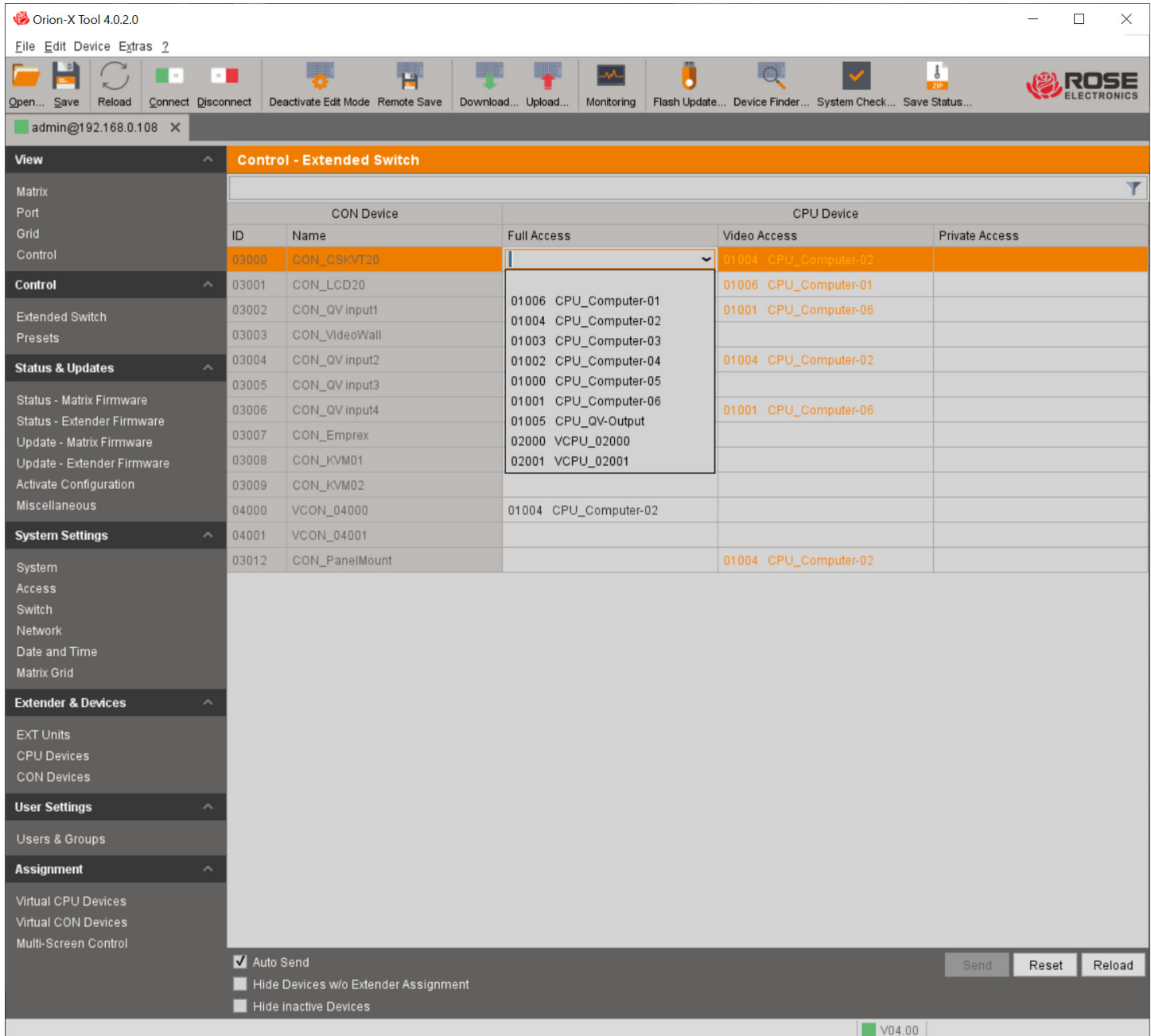



Figure 187. Full Access Selection List in the Java Tool

- ➔ To make a **video connection** between a console and a CPU, select the console, double-click on the corresponding selection box in the **Video Only** column and select the desired CPU from the drop-down list.
- ➔ To make a **Private Mode** connection between a console and a CPU, select the console, double-click on the corresponding selection box in the **Private Mode** column and select the desired CPU from the drop-down list.
- ➔ To **disconnect** the console's current connection, select the console, double-click on the corresponding selection box that shows the connection, and select blank entry at the top of the drop-down list.

**Note:** CPUs to which a console does not have access rights will not appear in the selection list.

When more than one console is connected to the same CPU, the following symbols are shown in the Extended Switch overview of connections:

Symbol	Description
	CON device is connected with <b>Shared Access</b> with at least one additional console to the same CPU. The CON device currently has a Full Access connection.
	CON device is connected with <b>Shared Access</b> with at least one additional console to the same CPU. The CON device currently has a Video Only connection.

**Table 64. Description of Connection Symbols in the Java Tool Extended Switch Screen**

Use the following buttons to execute switching operations:

Button	Function
<b>Send</b>	Send desired switching operations to the matrix
<b>Reset</b>	Disconnect all existing connections within the matrix
<b>Reload</b>	Reload switching status list

**Table 65. Buttons in the Java Tool Extended Switching Screen**

**Note:**

- When the **Auto Send** checkbox in the left lower corner of the work area is selected, switching operations will be completed as soon as a CPU is selected without needing to click the **Send** button.
- When the **Hide Devices w/o Extender Assignment** checkbox in the lower left corner of the work area is selected, only CON and CPU Devices that are assigned to extenders are shown.

## Method 2:

→ Select **View > Matrix** in the task area or select **View > Grid** when using a Matrix Grid.

To perform switching operations between CON and CPU devices proceed as follows:

1. Move the mouse cursor to the port that is to be switched.
2. Hold down the left mouse button and move the cursor to the port that is to be connected to the first port. The cursor movement will be indicated as a black line.

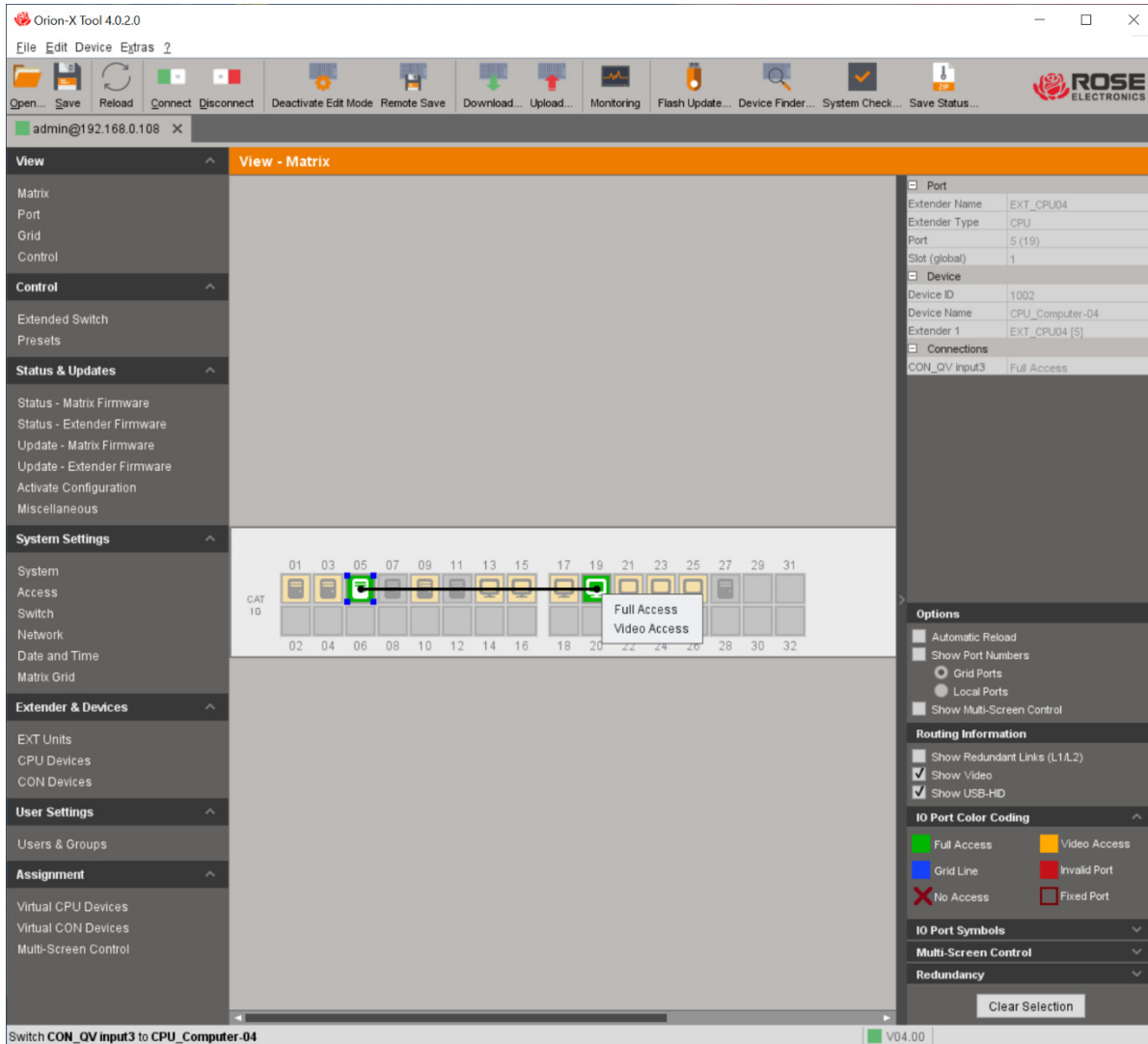

Figure 188. Extended KVM Switching through Java Tool - Method 2 (From View Matrix)

3. Release the left mouse button. A pop-up menu to select the available connection type (**Full Access**, **Video Access** or **Private Mode**) is displayed.
4. Select the desired switching type. The switching operation will be executed, and all extender units assigned to the selected devices will be switched.

**Note:** If there is a red X on a port when switching by using the **View > Matrix**, the console selected for connection does not have access rights to the CPU at that port.

To disconnect an existing connection between CON and CPU devices proceed as follows:

1. Right click on the port to be disconnected.
2. Select **Disconnect** in the drop-down list. The connected ports will be disconnected immediately, and all extenders assigned to those CON and CPU devices will be disconnected as well.

## Predefining Macros

This menu allows the creation and activation of predefined macros for switching the matrix without loading a new configuration. It is a function of the Java Tool, not the Matrix.

➔ Select **Control > Presets** in the task area.

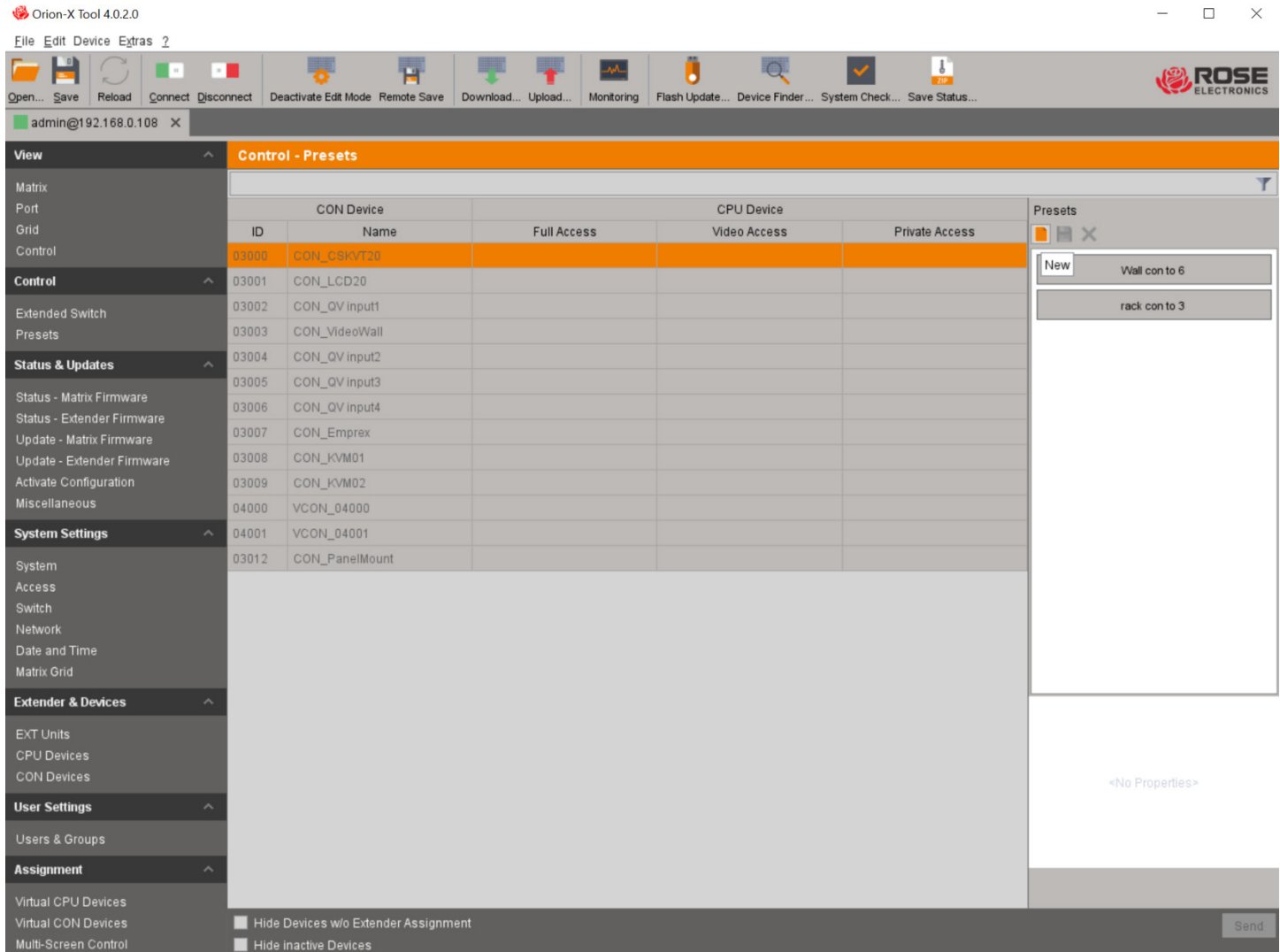

Figure 189. Setting up Macro Presets in the Java Tool

To create a new switch macro, proceed as follows:

1. Select a Console device and open a new switch macro by clicking on the **New** symbol in the Presets column. A prompt asks whether to use the existing connections in the new switch macro.

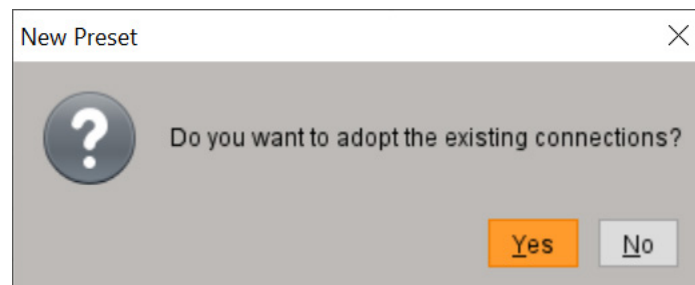
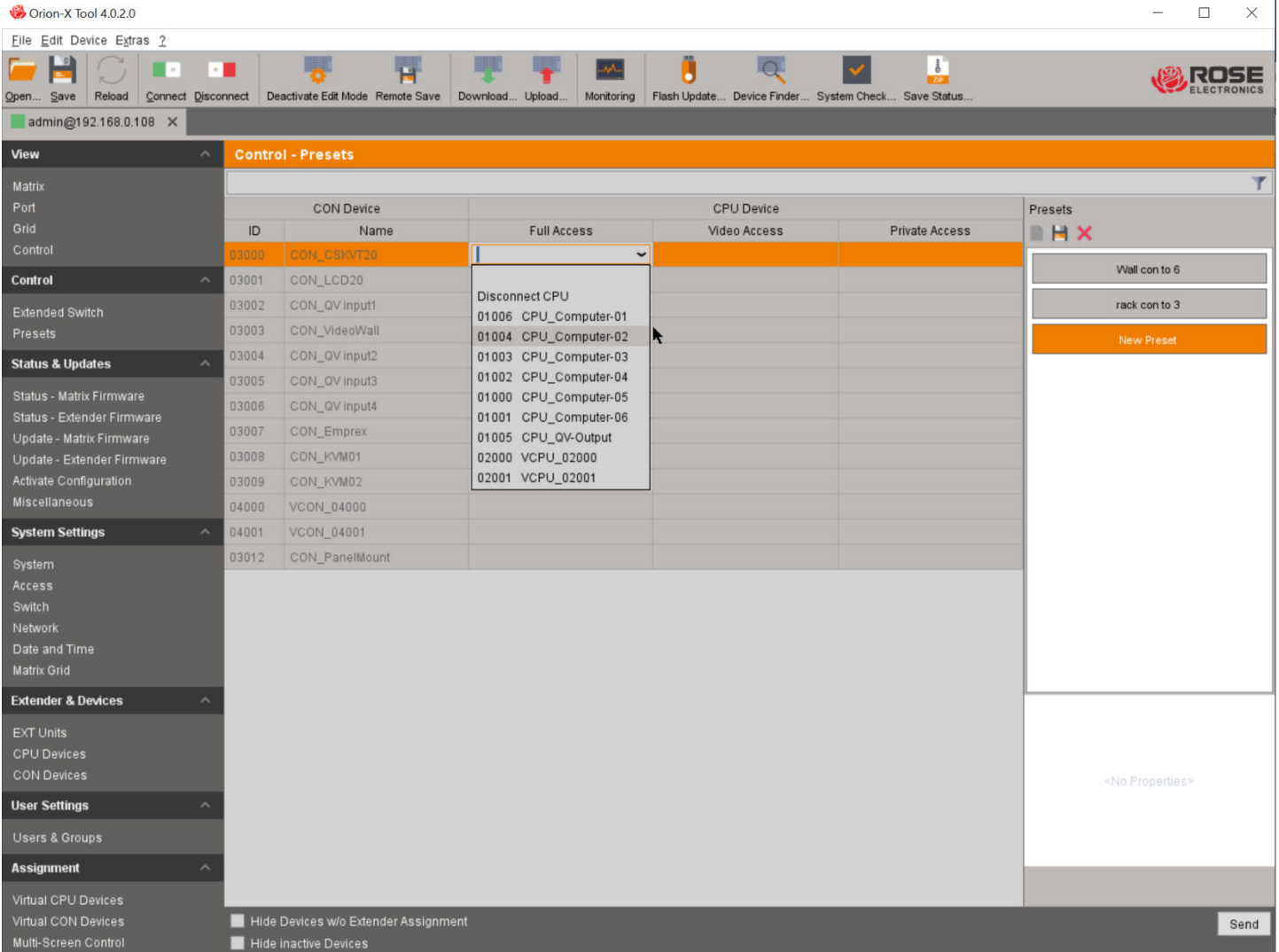

Figure 190. New Preset Macro Query

- Set the desired switching operation by double clicking in the appropriate column (**Full Access**, **Video Only** or **Private Mode**) and selecting the desired target (or select **Disconnect CPU**).



**Figure 191. Selecting the Preset Switching Operation**

- Save the created switch macro by clicking the **Save** symbol to the right of the **New** symbol in the Presets column of the working area. A Save Preset dialog will be opened.
- Enter a name for the new switch macro and confirm by clicking the **Ok** button in the dialog.
- By clicking on a selected switch macro with the right mouse button, you can create a copy of the current switch macro when using the **Save as...** option.
- Previously saved macros can be deleted by pressing the **Delete** symbol.

To load a switch macro preset to the matrix, proceed as follows:

- Select the switch macro to be loaded in the Presets column of the working area.
- Activate the selected macro by clicking the **Send** button below the Presets column.

**Note:**

- A predefined switch macro can only be executed in the Java Tool when edit mode is activated.
- Only switch macros that are hardware and current configuration compliant can be executed.

## Redundancy

KVM extenders with redundant interconnect connectors can be simultaneously operated with both connectors at a single Matrix or a Matrix Grid (firmware version V04.00 and later). KVM extender connectors labeled **Link 1** are for the primary connection. If the connection on either the CON or CPU Unit side is interrupted, the connection will be automatically reestablished through the connector labeled **Link 2**. This requires no configuration of the KVM matrix or the KVM extenders. If needed, it is possible to manually switch between **Link 1** and **Link 2** at the CON Unit (see [Switching a CON Unit to a Local Source with the OSD](#)).

Redundancy status can be checked with the OSD or the Java Tool.

### Monitoring Redundancy Status with the OSD

→ Display the main OSD menu and select **Switch**.

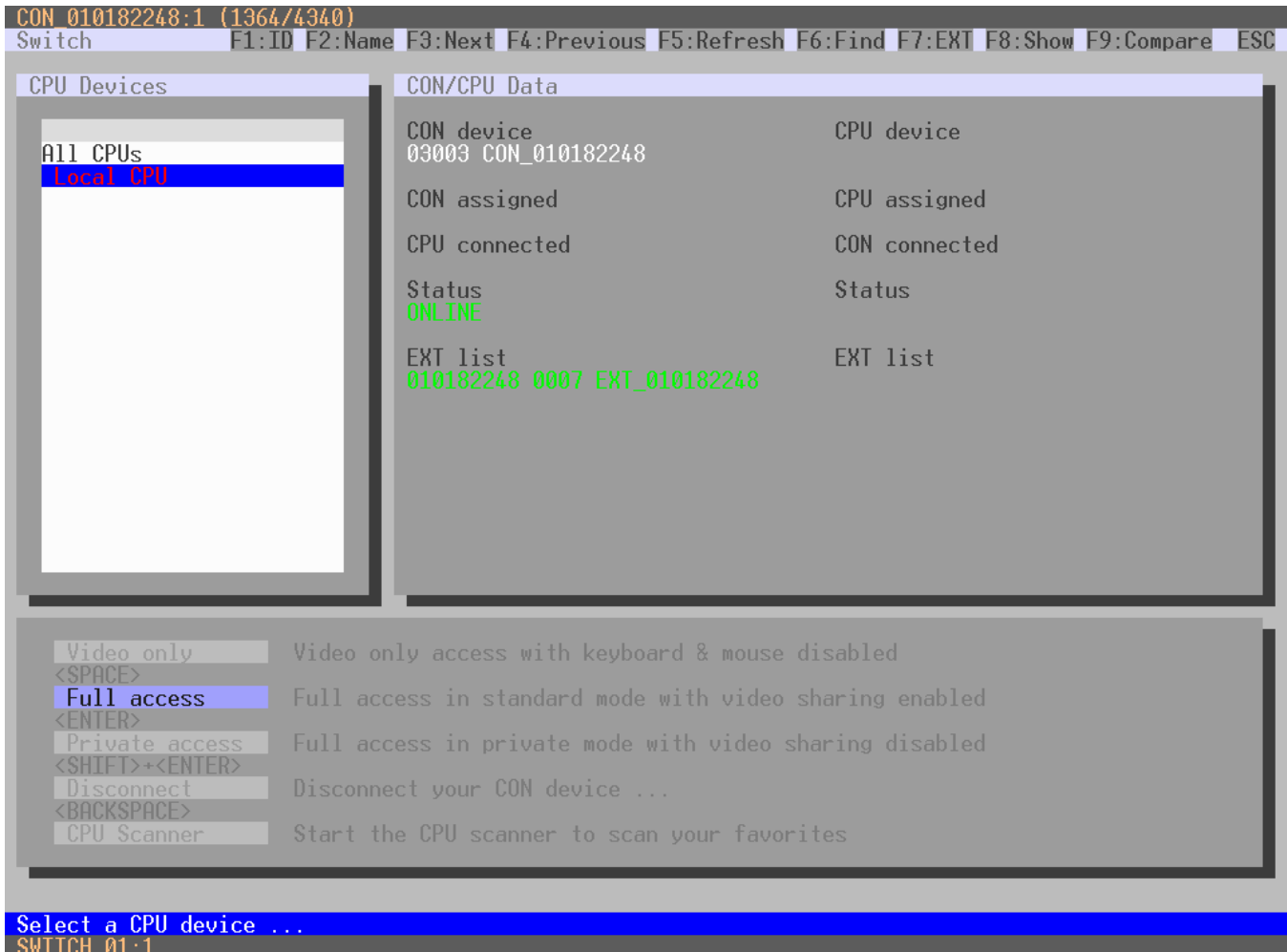

Figure 192. Checking Redundant Links with the OSD

When using redundant KVM extenders, the active connector of the selected extender is shown under **EXT list** in the field **CON/CPU Data**. If the first connector (**Link 1**) is active, it will be highlighted with **:1** behind the extender. If the second connector (**Link 2**) is active, this will be highlighted with **:2**.

## Monitoring Redundancy Status with the Java Tool

➔ Select **View > Matrix** in the task area.

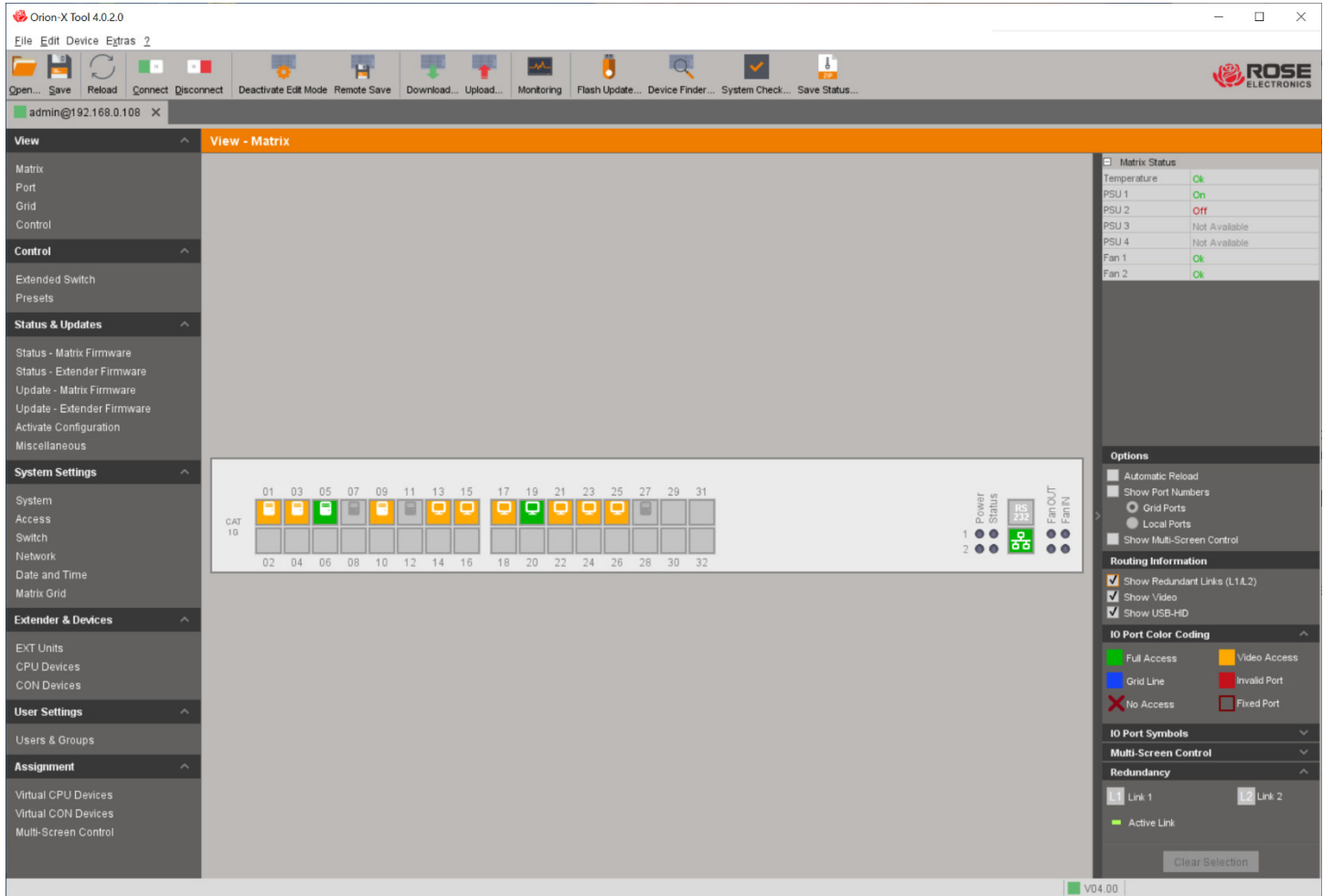

Figure 193. Checking Redundant Links with the Java Tool

In order to check the connection status of the redundant KVM extenders, proceed as follows:

1. Click the checkbox **Show Redundant Links (L1/L2)** under **Routing Information** on the right side of the working area.
2. Open the **Redundancy** menu on the right side of the working area to display current status of the redundant links.

Redundant connectors are highlighted in the **Matrix View** with **L1** and **L2**. The active link is highlighted with a light green label.

## Power Up and Power Down Functions

This section deals with power and firmware reset functions of the Orion FX.

### *Restart*

The Orion FX can be restarted through the OSD and the Java Tool.

#### Restarting Through the OSD

1. Display the main OSD menu, select **Configuration** and log in.
2. Select **Restart Matrix** or **Restart IO Board**.
3. Confirm the selection with **Okay** button.

The Orion FX and I/O boards will be restarted with the current settings.

#### Restarting through the Java Tool

1. Select **Device > Advanced Service** in the menu bar and select **Restart Matrix** in the drop-down menu.
2. Enter the Admin user credentials in the pop-up Authentication menu and click the **OK** button.

The Orion FX will be restarted with the current settings.

**Note:** The boot process of the matrix might take longer if no physical network connection is available.

### *Factory Reset*

Resetting the Orion FX or the IO Boards to factory default settings is available through the OSD and the Java Tool.

When a factory reset is performed, all current settings and all configurations stored in the matrix will be lost. This also applies to the network parameters (DHCP reset to **N**) and the admin password (reset to “admin”).

If firmware updates have been performed, the Orion FX will be set to the defaults defined in the most recent firmware applied.

#### Resetting Through the OSD

1. Display the main OSD menu, select **Configuration** and log in.
2. Select **Factory Reset**.
3. Confirm the selection with the **Okay** button.

The Orion FX will be reset to factory default settings.

#### Resetting Through the Java Tool

1. Select **Device > Advanced Service** in the menu bar.
2. Select **Restart Matrix** in the drop-down menu, and select either **Factory Reset** or **Factory Reset of I/O Boards**.
3. Enter the Admin user credentials in the pop-up Authentication menu and click the **OK** button.

## *Power Down*

A complete system shutdown can be performed through the OSD and the Java Tool. An I/O board shutdown can be performed through the OSD.

### Power Down through the OSD

To shut down the system, proceed as follows.

1. Display the main OSD menu, select **Configuration** and log in.
2. Select **Shut down Matrix**.
3. Confirm the selection with the **Okay** button.

The matrix will be shut down. Fans will be switched to maximum speed after the shutdown command, and then the Orion FX can be disconnected from power.

To shut down an I/O Board, proceed as follows.

1. Display the main OSD menu, select **Configuration** and log in.
2. Select **Shut down IO Board**.
3. Confirm the selection with the **Okay** button.

The I/O board will be shut down.

### Power Down through the Java Tool

To shut down the system, proceed as follows.

1. Select **Device > Advanced Service > Shutdown Matrix** in the menu bar.
2. Enter the Admin user credentials in the pop-up Authentication menu and click the OK button.

The Orion FX will be shut down.

## Summary of Keyboard Commands

The following two tables list all the keyboard commands that affect either extender functions or matrix functions. In the command notation, '+', and ',' have these meanings:

- <Key> + <Key> = Press keys simultaneously
- <Key>, <Key> = Press keys successively

### Extender Commands

Keyboard Command	Description
<'Hot Key'>, <a>	Download of DDC information for the monitor connected to the CON Unit into the CPU Unit
<'Hot Key'>, <k>, <1>, <Enter>	Switch to matrix KVM connection 1 (only with CON Units with connection available for a local source)
<'Hot Key'>, <k>, <2>, <Enter>	Switch to matrix KVM connection 2 (only with CON Units with connection available for a local source and a redundant interconnection)
<'Hot Key'>, <l>, <Enter>	Switch to local source (computer, CPU) (only with HDMI CON Units with connection available for a local source)
<'Hot Key'>, <h>, <w>, <Enter>	USB-HID Ghosting: Write device descriptions of the input devices connected to the CON Unit into the CPU Unit. Activate emulation in the CPU Unit.
<'Hot Key'>, <h>, <e>, <Enter>	Activate the emulation of already stored device descriptions in the CPU Unit
<'Hot Key'>, <h>, <d>, <Enter>	Deactivate the emulation of device descriptions in the CPU Unit. The input devices connected to the CON Unit will be passed transparently to the source (computer, CPU).
<'Hot Key'>, <h>, <r>, <Enter>	Deactivate the emulation of device descriptions in the CPU Unit, and remove the descriptions stored in the CPU Unit. The input devices connected to the CON Unit will be passed transparently to the source (computer, CPU).

**Table 66. Extender Keyboard Commands**

## Matrix Commands

Keyboard Command	Description
<'Hot Key'>, <o>	Open OSD
<'Hot Key'>, <m>, <o>	Open OSD of the master matrix in a cascaded environment
<'Hot Key'>, <s>, <o>	Open OSD of the sub matrix in a cascaded environment
<'Hot Key'>, <Backspace>	Close the current connection of the console
<'Hot Key'>, <p>	Switch back to the previously connected source (computer, CPU) with a KVM connection
<'Hot Key'>, <1> ... <16>, <Enter> (or <Space> + <Enter> or <Left Shift> + <Enter>)	Switch to a source (computer, CPU) stored in the favorites List with a KVM connection (video only or Private-Mode connection)
<'Hot Key'>, <F1> ... <F16>	Execute a predefined macro (1 - 16)
<'Hot Key'>, <Left Shift> + <F1> ... <F16>	Execute a predefined macro (17 - 32)
<'Hot Key'>, <c>, <new 'Hot Key'-Code>, <Enter>	Change the 'Hot Key' to one of the predefined values specified in the 'Hot Key' table
<'Hot Key'>, <c>, <0>, <new 'Hot Key' key >, <Enter>	Define a freely selectable new 'Hot Key'
<'Hot Key'>, <f>, <new 'Hot Key'-Code>, <Enter>	Change the 'Hot Key' for direct OSD access to one of the predefined values in the 'Hot Key' table
<'Hot Key'>, <f>, <0>, <new 'Hot Key' key>, <Enter>	Change the 'Hot Key' for direct OSD access to a user defined value
<'Hot Key'>, <Num 0>	Switch the USB-HID signals to the user's display (in Multi-screen control)
<Right Shift> + <Del>	Reset Hot Key to default settings, when executed within 5 seconds of plugging in a keyboard
<'Hot Key'>, <Num 1>	Switch the USB-HID signals to display #1 (in Multi-screen control)
<'Hot Key'>, <Num 2>	Switch the USB-HID signals to display #2 (in Multi-screen control)
<'Hot Key'>, <Num 3>	Switch the USB-HID signals to display #3 (in Multi-screen control)
<'Hot Key'>, <Num 4>	Switch the USB-HID signals to display #4 (in Multi-screen control)

**Table 67. Matrix Keyboard Commands**

# STATUS INDICATORS

## Diagnostics and Status

This section describes the diagnostics that are available on the Orion FX. Status indicators, both physically on the unit as LED indicators, and in the software, are discussed here.

### LED Indicators

The Orion FX units are fitted with the following LEDs for overall status indication.

#### *Device Status LEDs*

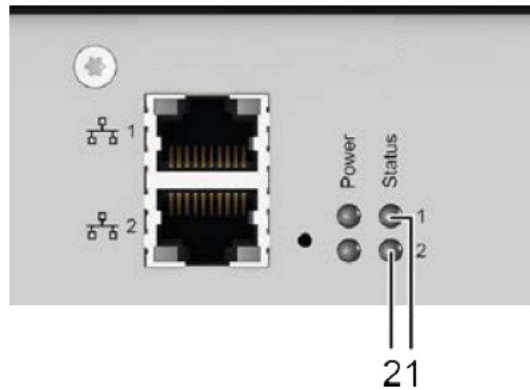

Figure 194. Device Status LED 1 and LED 2

LED 1	LED 2	Description
White	White	System is booting
Green	Off	System is ready
Red	Red	System is shutting down
Green flashing	Red flashing	System is off
Off	Blue	I/O modules are initialized

Table 68. Device Status Indicators

Due to variations in LED type, "white" might also appear as light purple or light blue.

### Port Link Status LEDs, CATx 1G

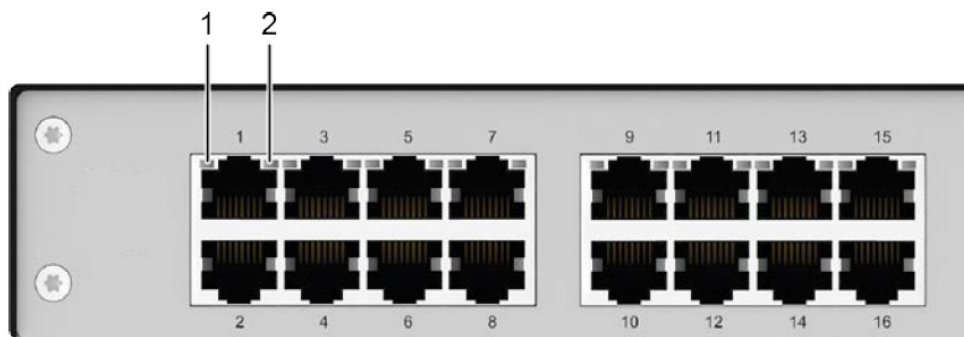

Figure 195. I/O Port Link Status Indicators, 1G CATx

LED 1 / 2	Description
Off	No connection detected
Orange	Cable connection ok, detecting extender
Green	Cable connection ok, data traffic active

Table 69. CATx 1G Link Status Indicators

### Port Link Status LEDs, CATx 3G

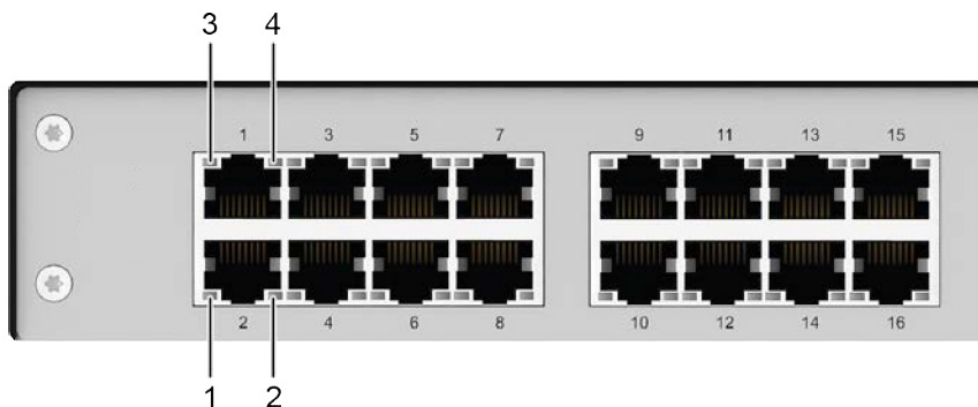

Figure 196. I/O Port Link Status Indicators, 3G CATx

- 1 – Link status LED 1 for lower port
- 2 – Link status LED 2 for lower port
- 3 – Link status LED 1 for upper port
- 4 – Link status LED 2 for upper port

LED 1 / 3	LED 2 / 4	Description
Off	Green	No connection detected
Orange	Green	Cable connection ok, detecting extender
Off	Green	Cable connection ok, data traffic active
Orange flashing	Off	Extender not detected

Table 70. CATx 3G Link Status Indicators

## Port Link Status LEDs, Fiber

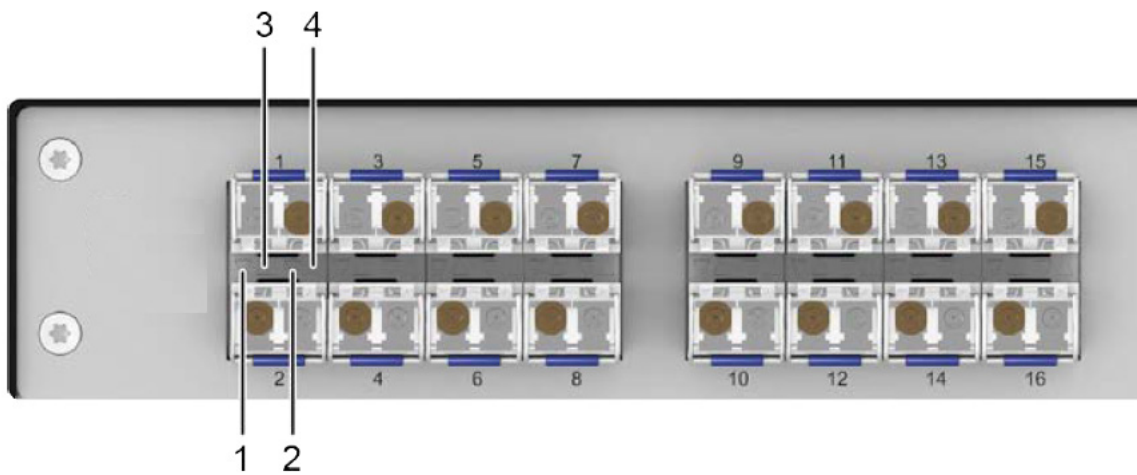

**Figure 197. I/O Board Port Link Status Indicators, Fiber**

- 1 – Link status LED 1 for lower port      3 – Link status LED 1 for upper port  
 2 – Link status LED 2 for lower port      4 – Link status LED 2 for upper port

LED 1 / 3	LED 2/ 4	Description
Green	Off	Connection established
Green	Red	Cable connection ok, detecting extender
Green	Off	Cable connection ok, data traffic active
Flashing Red	Off	Extender not detected

**Table 71. Fiber Link Status Indicators**

## Network Connection Link and Activity Status LEDs

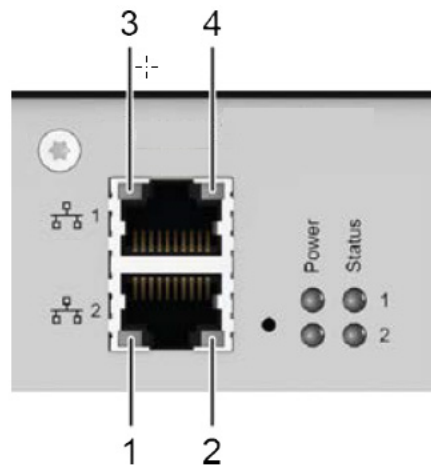

Figure 198. Network Connection Link and Activity Status LEDs

- 1 – Activity status LED network connection 2      3 – Activity status LED network connection 1  
 2 – Link status LED for network connection 2      4 – Link status LED for network connection 1

Position	LED	Status	Description
1 or 3	<b>Activity status</b> (Orange)	Off	No network connection available or Data traffic not active
		On	Network connection available, data traffic active
2 or 4	<b>Link Status</b> (Green)	Off	No network connection available
		On	Network connection available

Table 72. Network Connection Link and Activity Status Indicators

## Power Supply Status LEDs

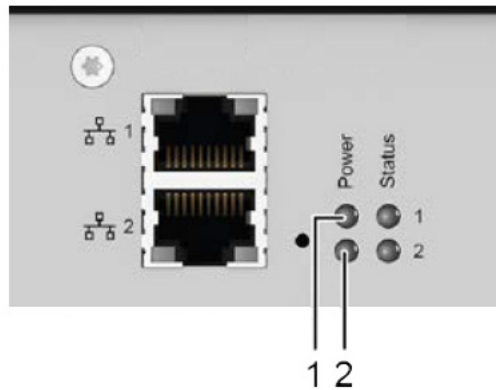

Figure 199. Power Supply Status Indicators

Pos.	LED	Status	Description
1	<b>AC Input 1</b> (Green)	On	Power supply 1 available
		Off	Power supply 1 not available
2	<b>AC Input 2</b> (Green)	On	Power supply 2 available
		Off	Power supply 2 not available

Table 73. Front Panel Power Supply Indicators

## Port Status

The connections and the switching status between the various consoles and CPUs are shown in this Java Tool menu.

### Viewing Port Status with the Java Tool

The current port configuration of the Orion FX is illustrated in this screen.

➔ Select **View > Matrix** in the task area when connected to the matrix.

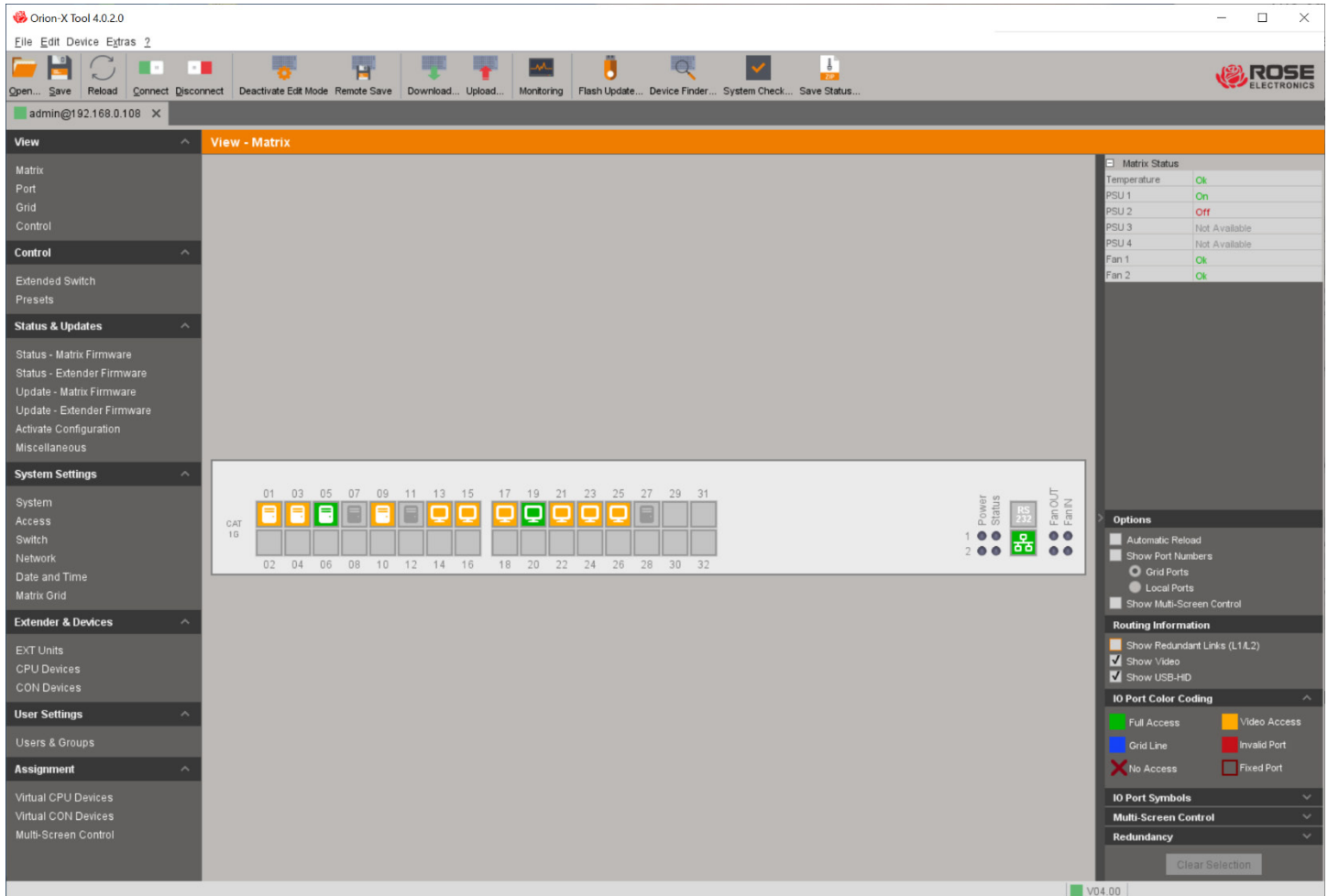











Figure 200. Viewing Port Status with the Java Tool

The colors indicate the connection status:

Color	Description
Grey	Port not connected
Orange	Video connection
Green	KVM connection
Red	Faulty Port
Blue	Port connected to another matrix through a Grid Line

Table 74. Color Indicators in the Java Tool Port Status Screen

The symbol indicates an extender that is recognized and defined at a certain port:

Symbol	Description
	Port connected to a CPU unit
	Port is connected to a CPU unit that is switched to a CON unit in <b>Private Mode</b>
	Port connected to a CON unit
	Port connected to a CON unit with <b>Shared Access</b> to a CPU.
	Port is connected to a CON unit that is connected to a CPU unit in <b>Private Mode</b>
	Port connected to an USB 2.0 CPU unit
	Port connected to an USB 2.0 CON unit
	Port is configured as Cascade-CON port for cascading of matrices.
	Port is configured as Cascade-CPU port for cascading of matrices.

**Table 75. Symbols in the Java Tool Port Status Screen**

- Red framed ports are defined as "fixed" (e. g. for USB 2.0 connections)
- The port with a static blue frame and blue squares at the corners is currently selected.
- If a port is selected, all the other ports will be displayed transparent except those that are connected to the currently selected port. A selection can be cleared by clicking the **Clear Selection** button.
- If a red X is shown on a port when attempting to switch with Matrix View, the console to be connected does not have access rights to the CPU at that port.

➔ Click the left mouse button on a port to select it and display its extender information on the right-hand side of the working area. The following information is available:

Field	Description
<b>Extender Name</b>	Name of the extender
<b>Extender Type</b>	Type of the extender
<b>Port</b>	Number of the selected port
<b>Slot (global)</b>	The slot location of the extender
<b>Device ID</b>	The Orion FX assigned Device ID number
<b>Device Name</b>	Name of the connected console or CPU device
<b>Extender</b>	Name of the selected extender
<b>Connections</b>	Listing of current devices connected to the selected port (Full or Video Access)

**Table 76. Extender Information for a Port in the Java Tool Port Status Screen**

➔ Click the right mouse button on a port to display the same information and also open the context menu for the port with available functions. The following context functions are available:

Function	Description
<b>Open Extender</b>	The extender definition menu will be opened
<b>Open Device</b>	The device definition menu will be opened
<b>Extended Switch</b>	The extended switching menu will be opened
<b>Disconnect</b>	Disconnect an existing connection
<b>Restart Extender</b>	Restart the extender
<b>Restart I/O Board</b>	Restart the extender's I/O board
<b>Factory Reset I/O Board</b>	Reset the extender's I/O board to factory defaults

**Table 77. Mouse Context Menu for a Port in the Java Tool Port Status Screen**

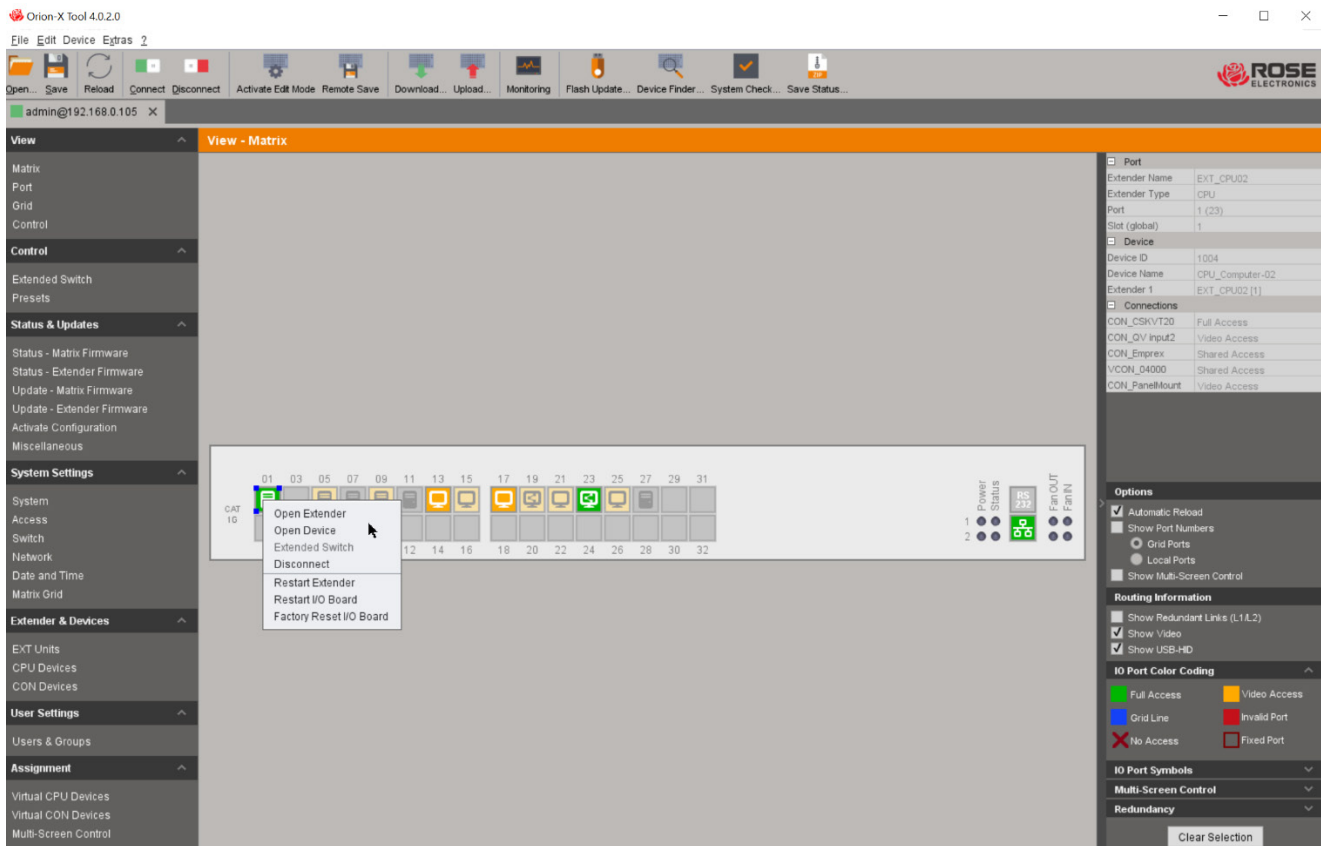

**Figure 201. Port Status Mouse Context Menu**

The Java Tool **View - Matrix** information can be reloaded in four ways:

- Press the <F5> key on the keyboard.
- Select **Edit > Reload** in the menu bar.
- Click the **Reload** button in the tool bar.
- Click the **Automatic Reload** checkbox in the right panel of the **View > Matrix** menu under **Options**.

## Port Status Matrix Grid

This Java Tool menu shows the connections and switching status between the CON and CPU Devices within a Matrix Grid.

The screen is divided into the different Grid matrices. Each matrix is displayed in an optimized view of 24 ports per line, in order to be able to show a larger number of ports,

➔ Select **View > Port** in the task area when connected to the matrix. If Orion FX units are connected in a Matrix Grid, they will appear in the display.

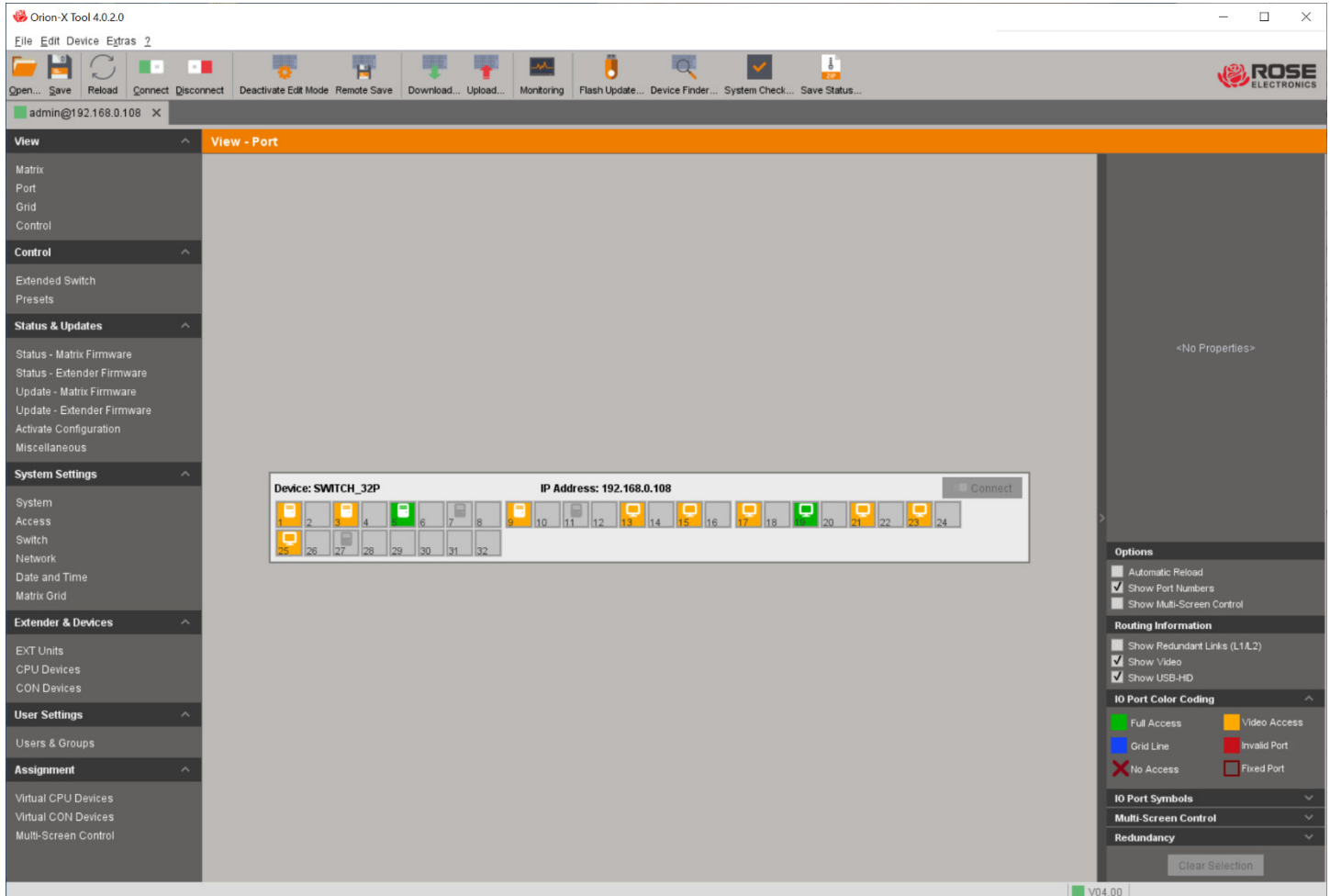

Figure 202. View Port Status Matrix Grid

**Note:** Functions, colors and symbols used in the View Port screen are identical to those used for port status in the Matrix View.

## Extender OSD

All CON extenders used with the Orion FX are provided with their own OSD to display the connection status of the console.

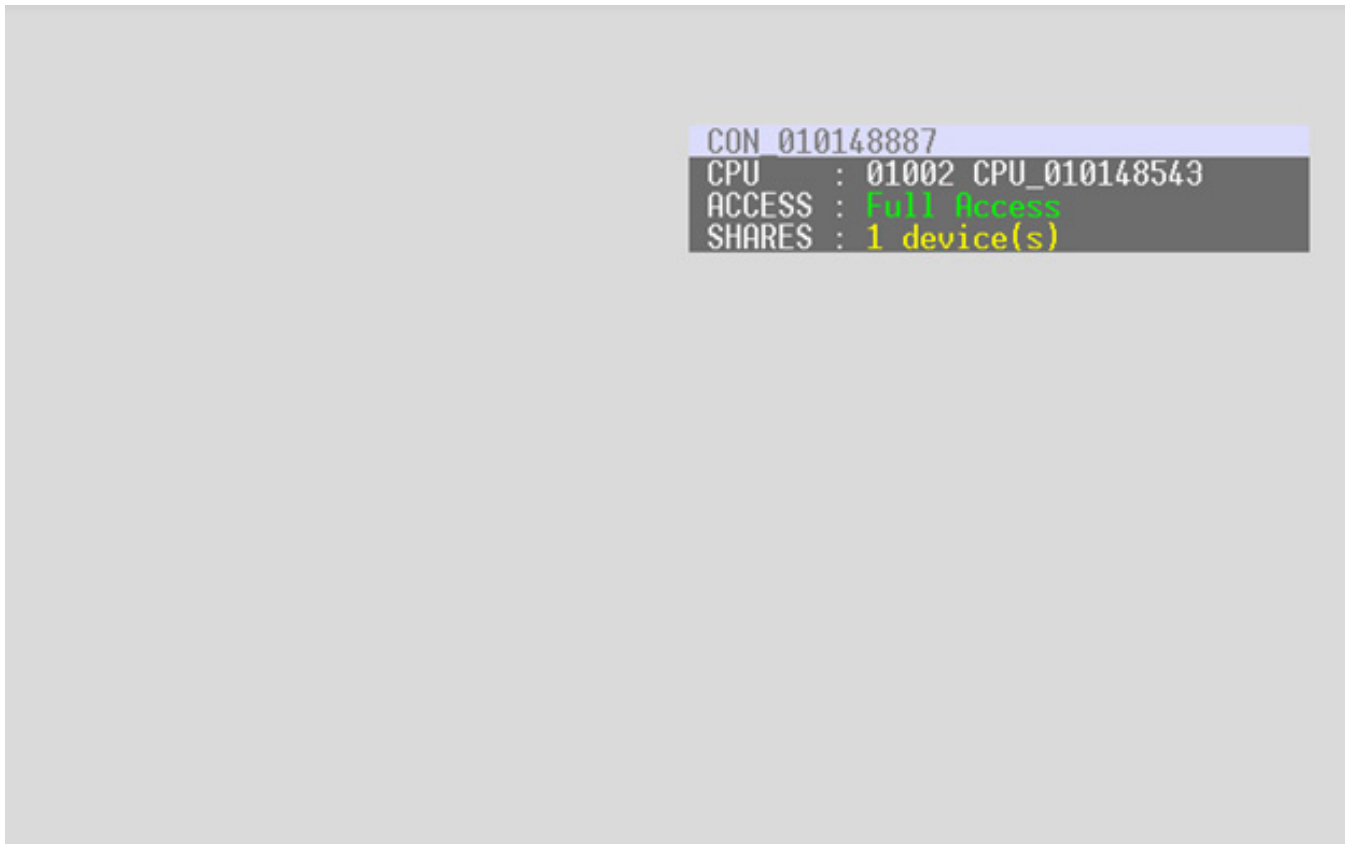

Figure 203. Extender OSD

The following information is shown in the OSD information screen:

Field	Description
CON	Name of the console
CPU	Name of the currently connected CPU <b>Color Coding:</b> <b>Green:</b> The connection to the CPU is completely established <b>Yellow:</b> The connection to the CPU is partially established <b>Red:</b> The connection to the CPU cannot be established <b>Note:</b> Possible reasons for incomplete or failed connection can be powered down extenders, or insufficient available Grid lines in Matrix Grid operation (the message <b>No more grid lines available</b> would be displayed).
ACCESS	<b>Full Access:</b> The console has a KVM connection to the displayed CPU. <b>Video Access:</b> The console has a video only connection to the displayed CPU. <b>Private Mode:</b> The console has a Private Mode connection to the displayed CPU. <b>Not connected:</b> The console is not connected to a CPU.
SHARES	<b>x device(s)</b> shows the number of devices that are connected to the console's currently connected CPU (e.g. 3 devices). If the field is blank, no other devices are connected to the current CPU.

Table 78. Information Displayed in the Extender OSD Screen

**Note:** If the Mouse Connect or Keyboard Connect options are active, the name of the console with keyboard/mouse control will be displayed at those consoles that do not currently have keyboard/mouse control. The console name is displayed in yellow color under Access.

## Network Status

The current network configuration is shown in this screen. This screen can be accessed through the OSD or the Java Tool.

The following information is shown in this menu:

Field	Description
<b>DHCP</b>	The network is allowed to assign network settings dynamically. Displays <b>YES</b> or <b>NO</b> .
<b>IP Address</b>	The current IP address of the matrix, whether provided manually or via DHCP
<b>Subnet Mask</b>	The current subnet mask, whether provided manually or via DHCP
<b>Gateway</b>	The current gateway address, whether provided manually or via DHCP
<b>Multicast</b>	The Multicast address, if there is a Matrix Grid within a Multicast group
<b>MAC ID</b>	The MAC address of the matrix

**Table 79. Network Status Settings**

### Viewing Network Status through the OSD

→ Select **Status > Network** in the main menu.

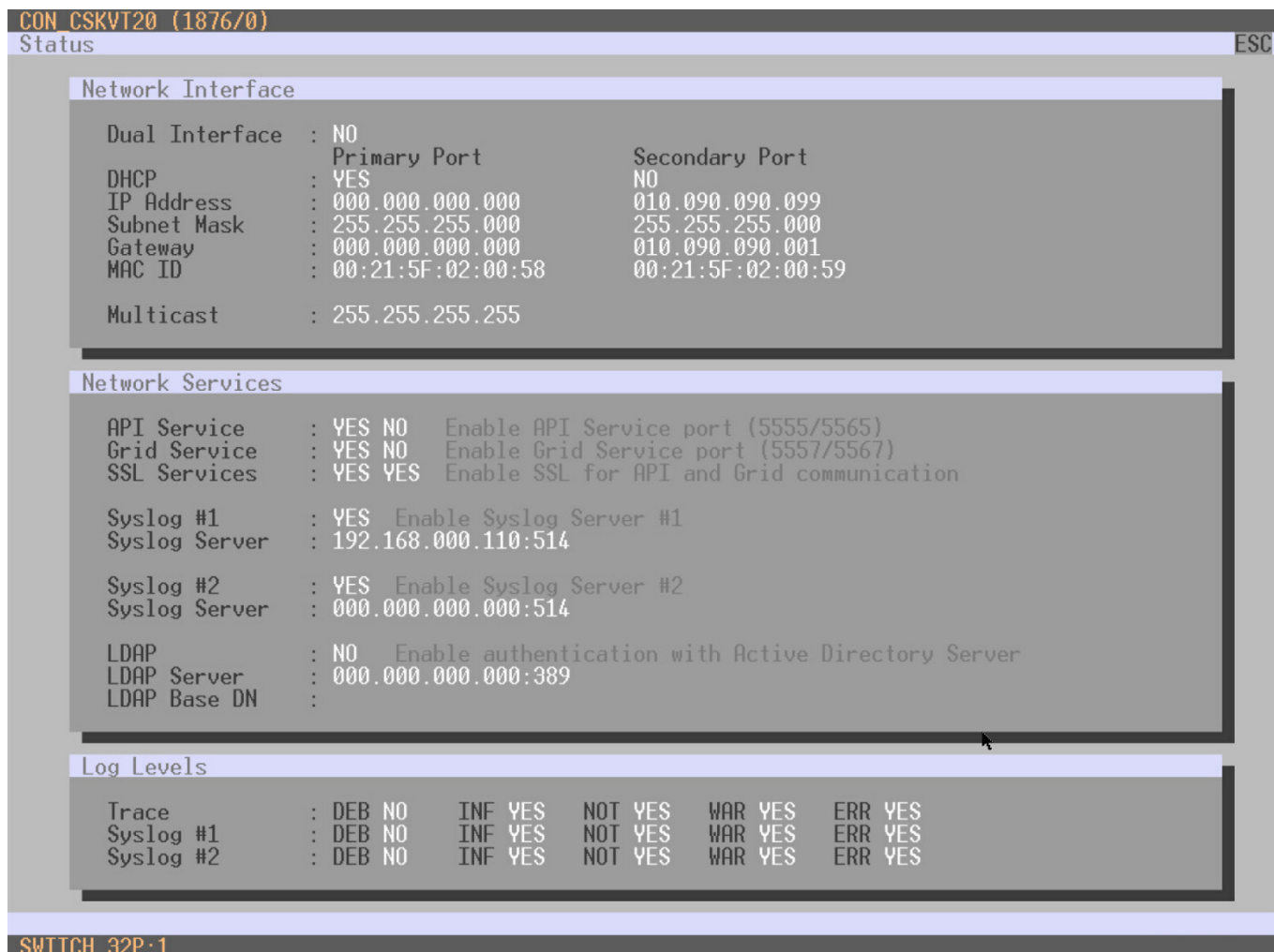

**Figure 204. Network Status in the OSD**

## Viewing Network Status with the Java Tool

➔ Select **System Settings > Network** in the Main Menu task area.

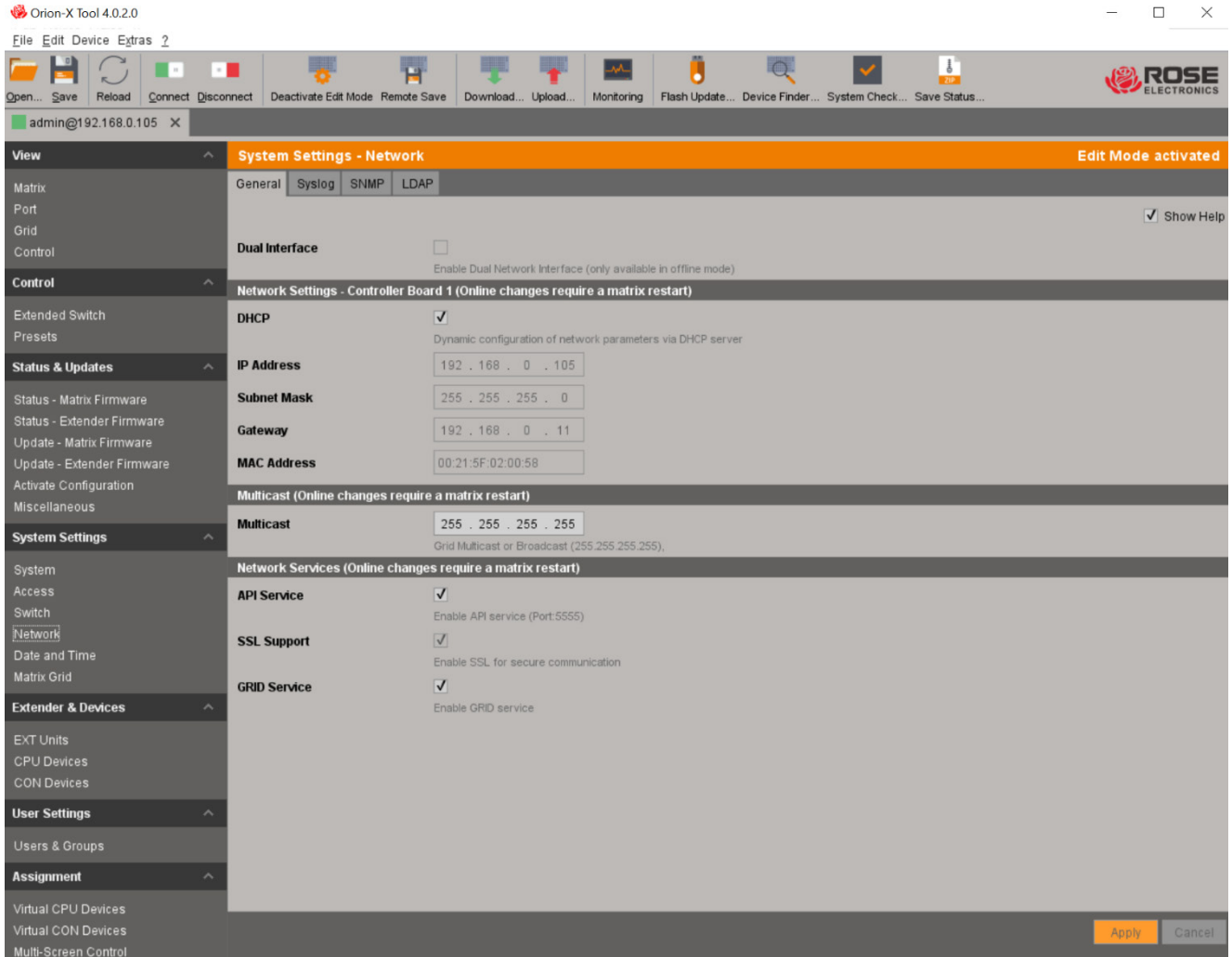

Figure 205. Viewing Network Status through the Java Tool

## Matrix Firmware Status

The current firmware status of the installed boards is shown in this menu. It can be accessed through the OSD and the Java Tool.

The following information is shown in this screen:

Field	Description
<b>Name</b>	Description of the modules
<b>Type</b>	Type of the modules by functionality
<b>Ports</b>	Number of ports
<b>Version</b>	Complete description of the firmware version
<b>Date</b>	Date of the firmware version
<b>Status</b>	Module status (Java Tool only)

Table 80. Information Displayed in the Matrix Firmware Status Screen

## Firmware Status through the OSD

→ Select **Status > Firmware** in the main menu.

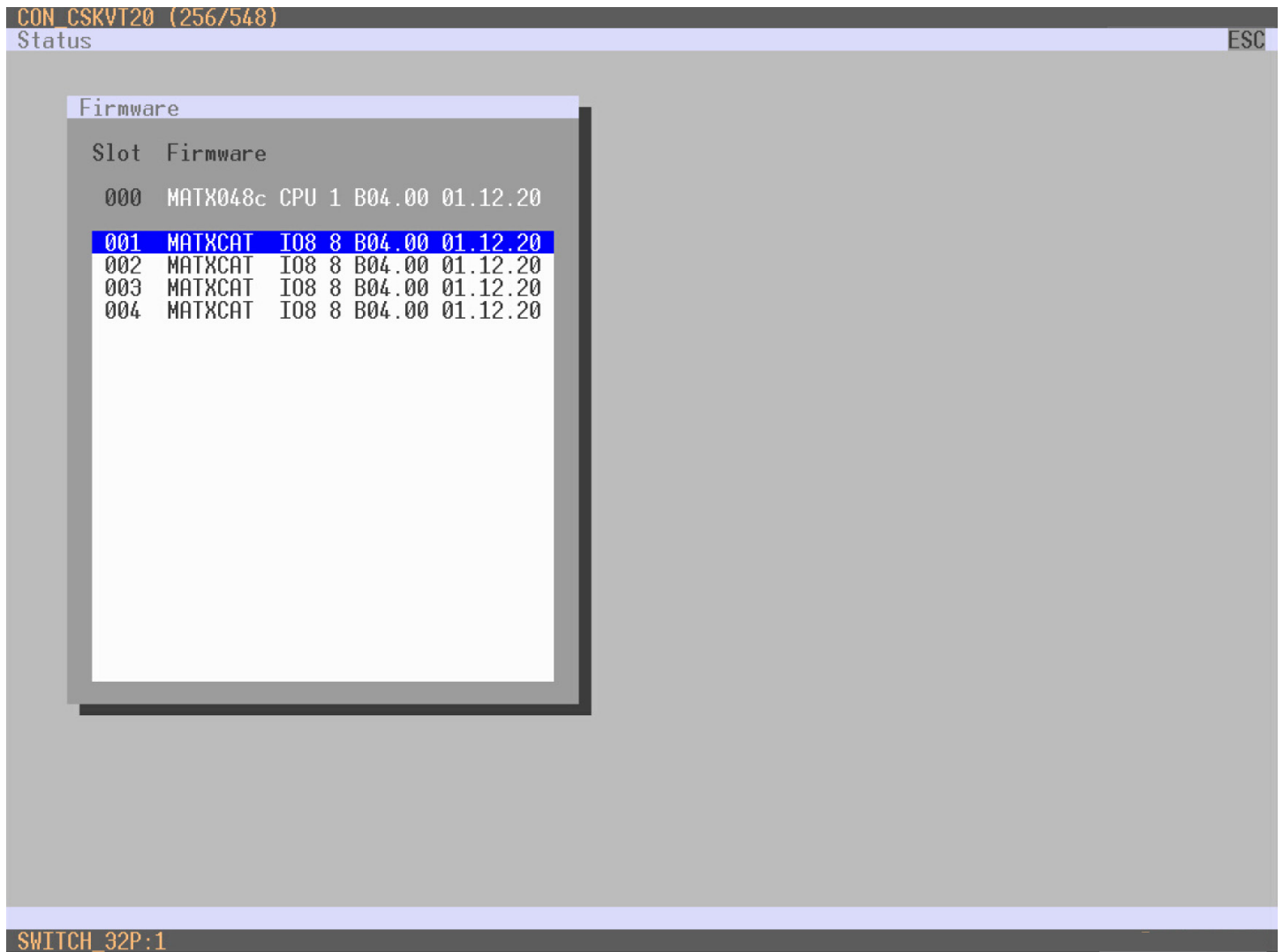

Figure 206. Firmware Status through the OSD

## Firmware Status through the Java Tool

Select **Status & Updates > Status – Matrix Firmware** in the task area.

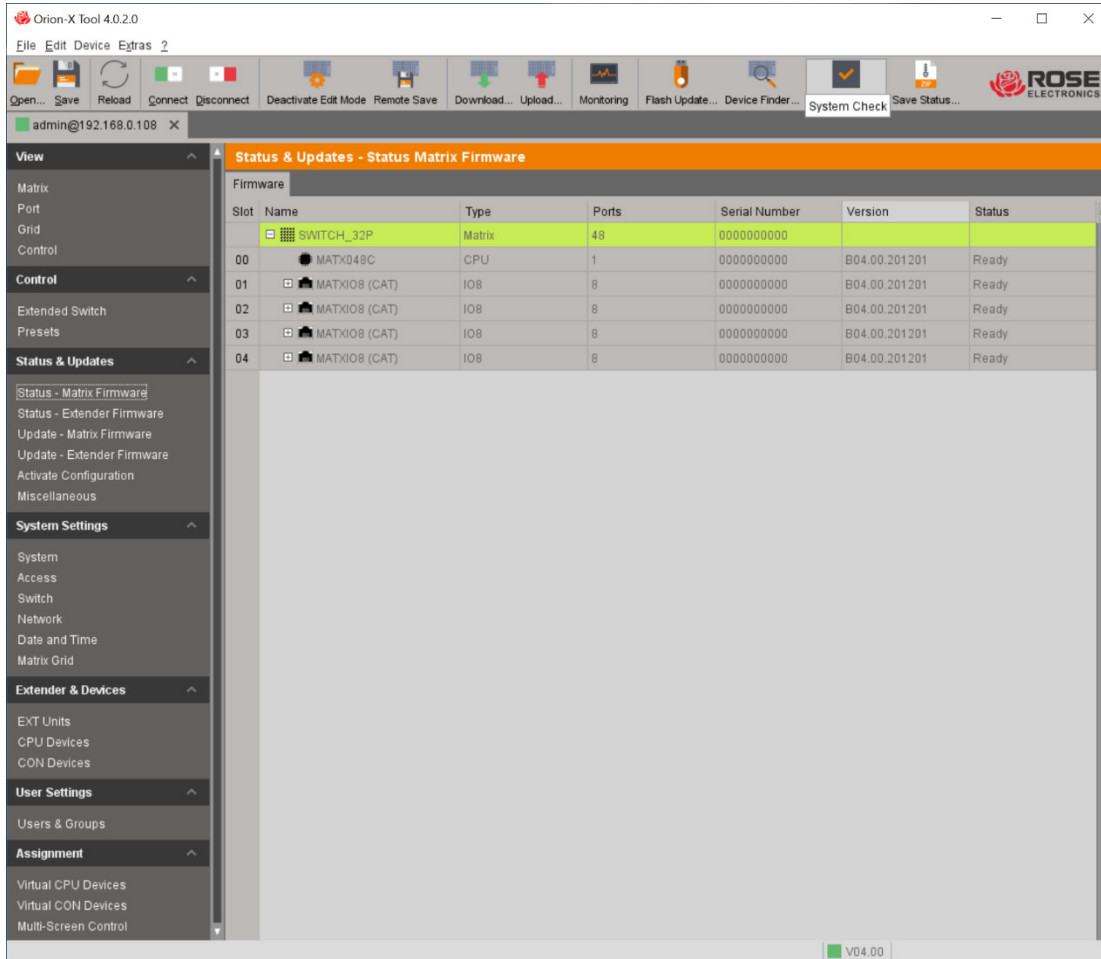

Figure 207. Viewing Firmware Status through the Java Tool

The current firmware status can be stored as a file in the computer running the Java Tool (file extension **.zip**).

1. Select **Device > Save Status** in the menu bar, or click the **Save Status** icon in the tool bar.

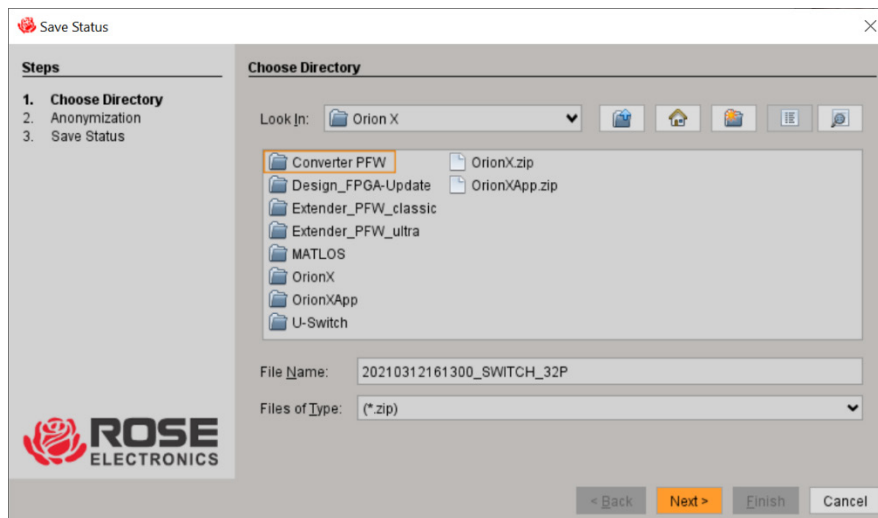

Figure 208. Save Status Location and File Name in the Java Tool

2. Select a location and name for the file and click the **Next** button.

3. To save the file with personal data rendered anonymous, click the Anonymize checkbox and click **Next**.

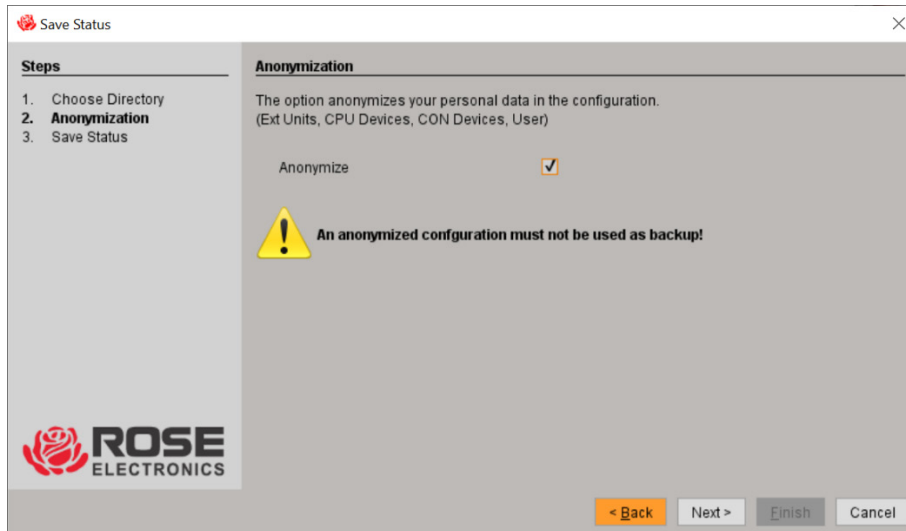

Figure 209. Save Status Anonymous Option in the Java Tool

4. Click the **Finish** button when all steps are complete.



Figure 210. Save Status Steps in the Java Tool

## Extender Firmware Status

The current firmware status of the connected extenders is shown in this menu, found in the Java Tool.

The following information is shown in this screen.

Field	Description
<b>ID</b>	Serial number of the extender
<b>Name</b>	Name assigned to the extender unit
<b>Port</b>	I/O port where the extender is connected to the matrix
<b>Type</b>	Description of the extender module and its components
<b>Device</b>	Device associated with the extender
<b>Version</b>	Current firmware version by component

Table 81. Information Displayed in the Extender Firmware Status Screen

→ Select **Status & Updates > Status - Extender Firmware** in the task area.

The screenshot shows the Orion-X Tool 4.0.2.0 interface. The main window is titled "Status & Updates - Status Extender Firmware". It features a sidebar on the left with navigation options like "View", "Control", "Status & Updates", "System Settings", "Extender & Devices", "User Settings", and "Assignment". The main area displays a table of extender components. The table has columns for "#", "ID", "Name", "Port", "Type", "Device", and "Version". The first row, "SWITCH\_32P", is highlighted in green. Below the table, a legend explains the color coding: yellow for "Extender firmware version conflict", orange for "Manual update of EXTMSD / EXTIMSD recommended", red for "Wrong module type (CPU/CON mismatch)", and blue for "Undefined type". The bottom right corner shows the version "V04.00".

#	ID	Name	Port	Type	Device	Version
	SWITCH_32P	SWITCH_32P		Matrix		
01	10173373	EXT_CPU02	1	CPU UNIT	CPU_Computer-02	
02	10173372	EXT_CPU01	3	CPU UNIT	CPU_Computer-01	
03	10216759	EXT_CPU04	5	CPU UNIT	CPU_Computer-04	
04	10173392	EXT_CPU03	7	CPU UNIT	CPU_Computer-03	
05	10173401	EXT_CPU06	9	CPU UNIT	CPU_Computer-06	
06	10157706	EXT_CPU05	11	CPU UNIT	CPU_Computer-05	
07	10157576	EXT_PanelMount	13	CON UNIT	CON_PanelMount	
08	10173315	EXT_QV Input1	15	CON UNIT	CON_QV input1	
09	10173352	EXT_QV Input2	17	CON UNIT	CON_QV input2	
10	10173347	EXT_QV Input3	19	CON UNIT	CON_QV input3	
11	10173266	EXT_QV Input4	21	CON UNIT	CON_QV input4	
12	10173282	EXT_CSKVT20	23	CON UNIT	CON_CSKVT20	
13	10173269	EXT_LCD20	25	CON UNIT	CON_LCD20	
14	10154890	EXT_QVOUTPUT	27	CPU UNIT	CPU_QV-Output	

Figure 211. Extender Firmware Status in the Java Tool

To view the version of each type of firmware in an extender, click the plus box in front of an extender's ID to expand the entry.

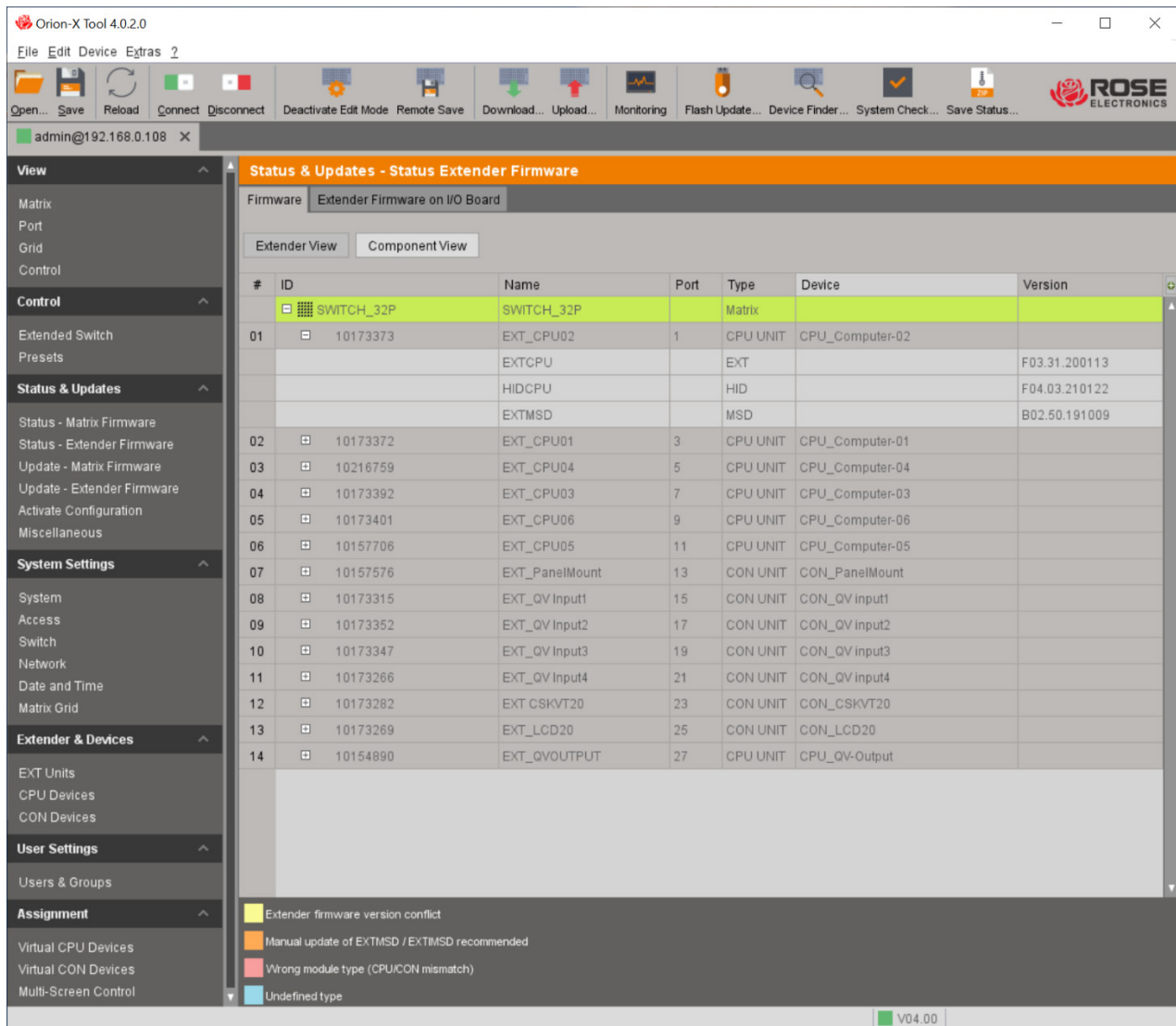

Figure 212. Expanded Firmware Status of Extender with the Java Tool

Firmware types to be updated, or firmware conflicts are highlighted in color.





Color	Description
	Extender firmware version conflict
	Manual update of EXTMSD / EXTMSD recommended*
	Wrong module (CPU/CON mismatch)
	Undefined type

Table 82. Extender Firmware Update Indicators in the Java Tool

\*Updating EXTMSD firmware is only required when it is specifically advised by Technical Support. EXTMSD firmware must be manually updated via the mini-USB service port of the extender modules.

## Extender Firmware on I/O Board Status

The Extender firmware currently stored in the memory of the I/O boards can be viewed in this menu. The firmware name, type, and version are displayed in this menu, along with the I/O board memory usage.

1. Select **Status & Updates > Status - Extender Firmware** in the task area.
2. Select **Extender Firmware Status on I/O Board** tab in the working area.

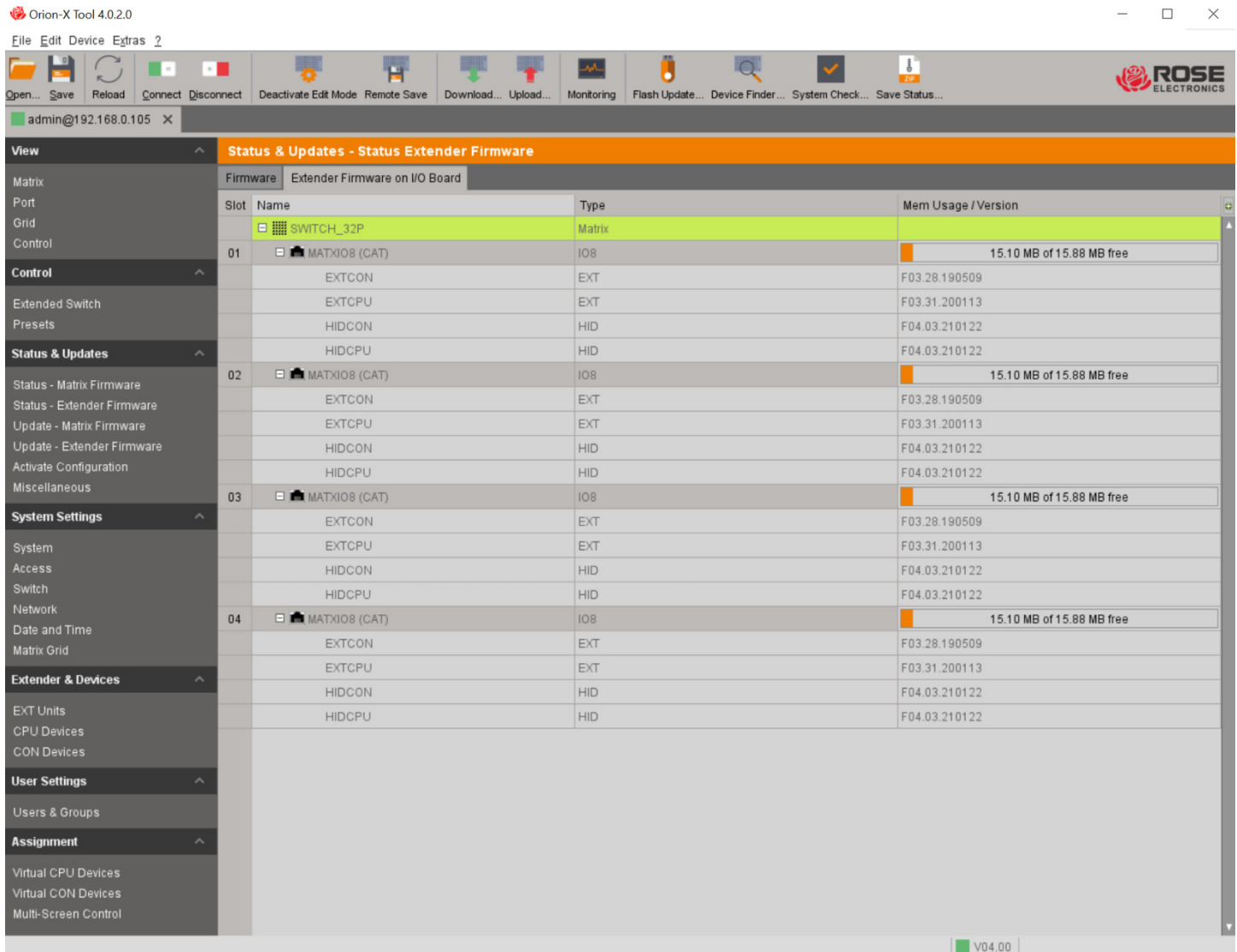

Figure 213. Extender Firmware on I/O Board Status

The following information is displayed in the working area:

Column	Description
Slot	Slot number of the I/O Board
Name	Name of the I/O Board and the extender module firmware
Type	Type of the I/O board and the extender module firmware
Mem Usage / Version	<ul style="list-style-type: none"> <li>Memory used on the I/O board</li> <li>Extender Firmware versions stored on the I/O Board</li> </ul>

Table 83. Information Displayed in the Extender Firmware on I/O Board Status Screen

## Trace Function

This function is used for diagnostic purposes. All events in the Orion FX matrix are logged and displayed in this screen. This screen can be accessed from the OSD.

The following information is shown in this menu:

Field	Description
Date	Event date stamp
Time	Event time stamp
Message	Detailed description of the event

Table 84. Information Displayed in Trace Function

→ Select **Status > Trace** in the OSD menu.

```

CON 010191923 (256/0)
Status
Trace
Date      Time      Message
2020/08/15 14:31:59.00 NOT scrHandleOpen(): PORT=1
2020/08/15 14:31:56.00 NOT scrHandleTimeout(): PORT=1 SETHOSTID
2020/08/15 14:31:56.00 WAR picRetVersion(): PORT=1 ID=5 empty
2020/08/15 14:31:56.00 WAR picRetVersion(): PORT=1 ID=4 empty
2020/08/15 14:31:51.00 NOT scrUpdateRX(): PORT=1 RX=ON
2020/08/15 14:31:51.00 NOT catUpdatePortStatus(): PORT=1 REQ=RXON
2020/08/15 14:31:51.00 NOT catUpdatePortStatus(): PORT=1 SYNC=1
2020/08/15 14:26:17.00 NOT catUpdatePortStatus(): PORT=1 CAT=1
2020/08/15 14:26:16.00 NOT scrUpdateRX(): PORT=1 RX=OFF
2020/08/15 14:26:16.00 ERR catErrorHandler(): PORT=1 stopped
2020/08/15 14:26:16.00 WAR catErrorHandler(): PORT=1 restart
2020/08/15 14:26:10.00 NOT scrUpdateRX(): PORT=1 RX=ON
2020/08/15 14:26:10.00 NOT catUpdatePortStatus(): PORT=1 REQ=RXON
2020/08/15 14:26:10.00 NOT catUpdatePortStatus(): PORT=1 SYNC=1
2020/08/15 14:26:08.00 NOT scrUpdateRX(): PORT=1 RX=OFF
2020/08/15 14:26:07.00 WAR catUpdatePortStatus(): PORT=1 REQ=RXOFF
2020/08/15 14:26:07.00 NOT scrUpdateRX(): PORT=1 RX=ON
2020/08/15 14:26:07.00 NOT catUpdatePortStatus(): PORT=1 REQ=RXON
2020/08/15 14:26:07.00 NOT catUpdatePortStatus(): PORT=1 SYNC=1
2020/08/15 14:26:07.00 NOT catUpdatePortStatus(): PORT=1 CAT=1
2020/08/15 14:26:07.00 NOT scrUpdateRX(): PORT=1 RX=OFF
2020/08/15 14:26:06.00 WAR catErrorHandler(): PORT=1 restart
2020/08/15 14:26:00.00 NOT scrUpdateRX(): PORT=1 RX=ON
2020/08/15 14:26:00.00 NOT catUpdatePortStatus(): PORT=1 REQ=RXON
2020/08/15 14:26:00.00 NOT catUpdatePortStatus(): PORT=1 SYNC=1
2020/08/15 14:25:57.00 NOT scrUpdateRX(): PORT=1 RX=OFF
2020/08/15 14:25:57.00 WAR catUpdatePortStatus(): PORT=1 REQ=RXOFF
2020/08/15 14:25:57.00 NOT scrUpdateRX(): PORT=1 RX=ON
2020/08/15 14:25:57.00 NOT catUpdatePortStatus(): PORT=1 REQ=RXON
2020/08/15 14:25:57.00 NOT catUpdatePortStatus(): PORT=1 SYNC=1
2020/08/15 14:25:57.00 NOT catUpdatePortStatus(): PORT=1 CAT=1
2020/08/15 14:25:57.00 NOT scrUpdateRX(): PORT=1 RX=OFF
SWITCH 01:1

```

Figure 214. Trace Log Monitoring in the OSD

## Syslog Monitoring

The Syslog function offers complete logging of matrix activities and switching operations. During logging, the activities are written continuously into log files and stored locally. This function is found in the Java Tool. To set up and activate and the Syslog function, see [Activating Syslog](#).

**Note:** Syslog messages are transmitted via UDP. Network port 514 should not be blocked by a firewall. To start Syslog Monitoring proceed as follows.

➔ Select **Device > Monitoring** in the menu bar, or click the **Monitoring** icon in the tool bar.

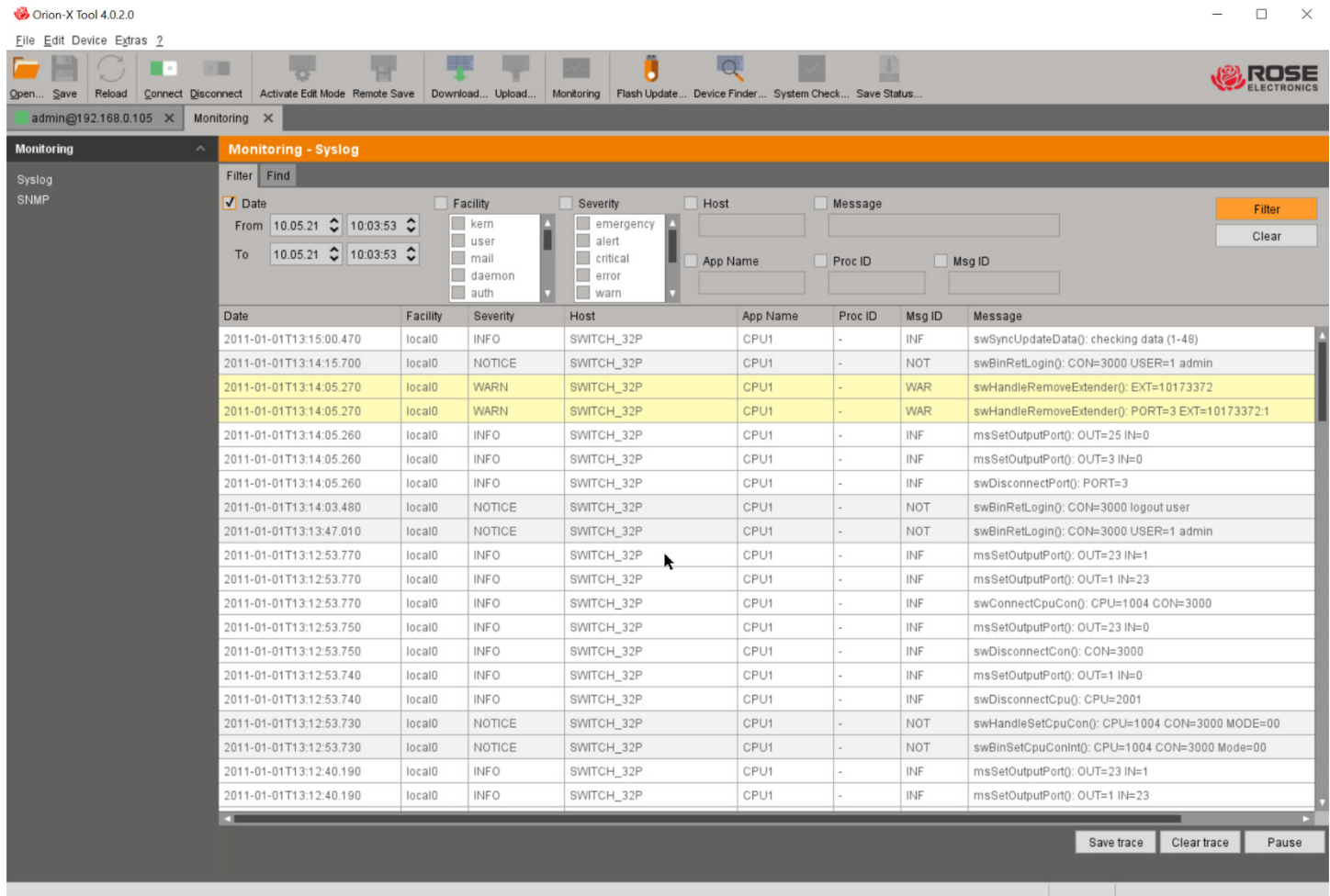

Figure 215. Syslog Monitoring with the Java Tool

The logging of system activities starts when the **Monitoring** menu is opened, and remains active until the tab is closed.

During logging, the activities are written continuously into logging files and stored locally. This logging process includes a number of options as described below.

## Filter Function

To filter relevant messages out of a number of logged activities of the Orion FX, Syslog Monitoring offers various filter options. These are set up using the fields at the top of the Syslog screen.

To set and activate a filter, proceed as follows:

1. Set the desired filter option(s) by clicking the appropriate checkbox(es).
2. Activate the filter settings by pressing the **Filter** button.

To deactivate an activated filter setting, press the **Clear** button.

The following filter options are available:

Option	Description
<b>Date</b>	Messages of a defined date range will be displayed
<b>Facility</b>	Messages of a defined facility will be displayed
<b>Severity</b>	Messages of a specified severity will be displayed
<b>Host</b>	Messages of a named Orion FX will be displayed
<b>Message</b>	Messages containing specified text will be displayed

**Table 85. Filter Options for Syslog Monitoring**

**Note:** Filter options are not valid in stored log files.

## Recording Function

Syslog messages shown in the Monitoring window can be saved or deleted.

- ➔ To store the messages shown in the Syslog (filtered or unfiltered), click the **Save trace** button. The messages will be stored in a text file with the .csv extension.
- ➔ To remove the messages shown in the Syslog, click the **Clear trace** button.
- ➔ To stop recording the messages, click the **Pause** button. To continue, click the button again.

## Syslog Find Function

The find function can be used to find specific Syslog messages in a variety of logged activities from the matrix, extender modules, and chassis.

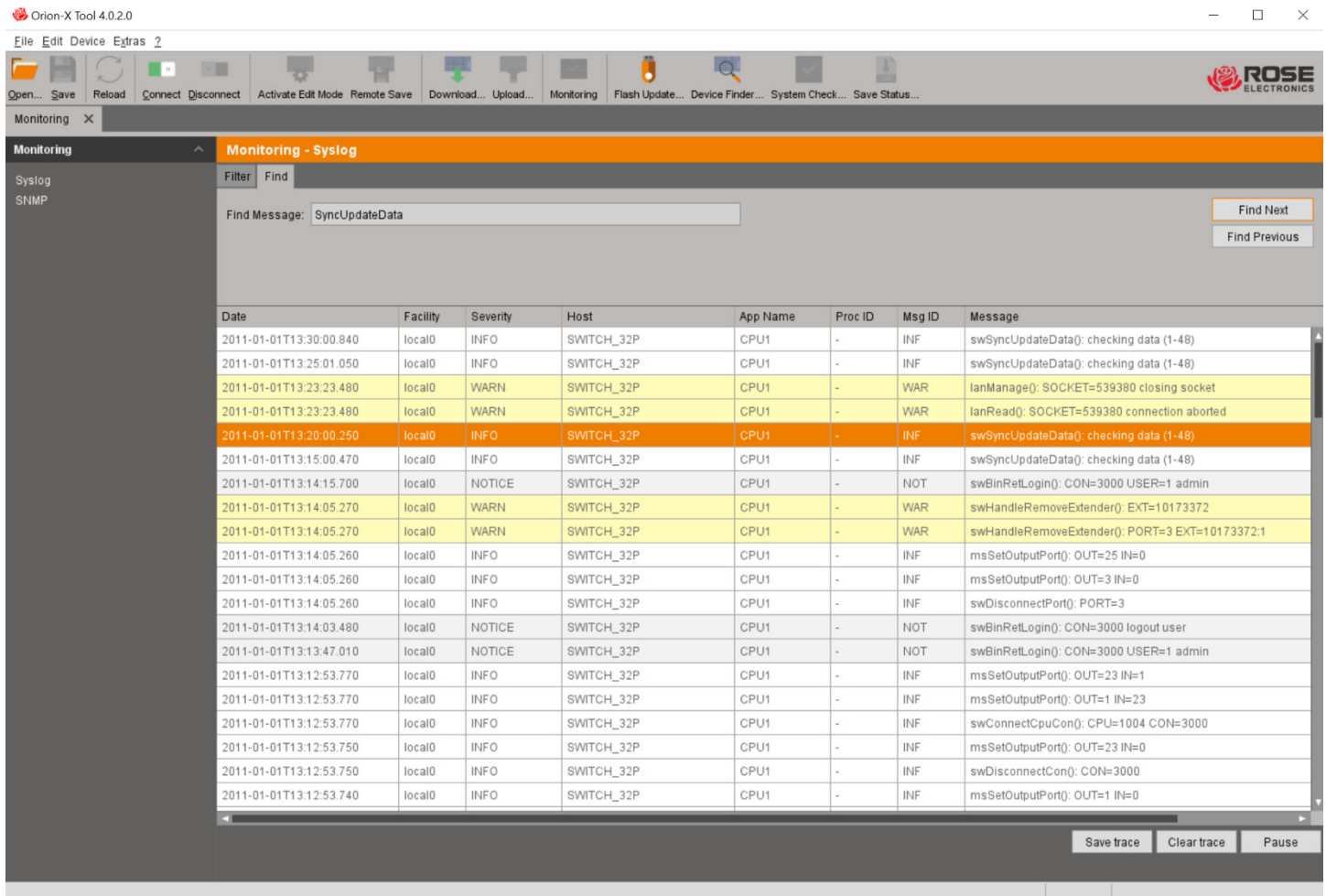

The screenshot shows the Orion-X Tool 4.0.2.0 interface. The 'Monitoring - Syslog' window is open, displaying a list of Syslog messages. The search term 'SyncUpdateData' is entered in the 'Find Message' field. The 'Find Next' button is highlighted, and the first message in the list is highlighted in orange.

Date	Facility	Severity	Host	App Name	Proc ID	Msg ID	Message
2011-01-01T13:30:00.840	local0	INFO	SWITCH_32P	CPU1	-	INF	swSyncUpdateData(): checking data (1-48)
2011-01-01T13:25:01.050	local0	INFO	SWITCH_32P	CPU1	-	INF	swSyncUpdateData(): checking data (1-48)
2011-01-01T13:23:23.480	local0	WARN	SWITCH_32P	CPU1	-	WAR	lanManage(): SOCKET=539380 closing socket
2011-01-01T13:23:23.480	local0	WARN	SWITCH_32P	CPU1	-	WAR	lanRead(): SOCKET=539380 connection aborted
2011-01-01T13:20:00.250	local0	INFO	SWITCH_32P	CPU1	-	INF	swSyncUpdateData(): checking data (1-48)
2011-01-01T13:15:00.470	local0	INFO	SWITCH_32P	CPU1	-	INF	swSyncUpdateData(): checking data (1-48)
2011-01-01T13:14:15.700	local0	NOTICE	SWITCH_32P	CPU1	-	NOT	swBinRetLogin(): CON=3000 USER=1 admin
2011-01-01T13:14:05.270	local0	WARN	SWITCH_32P	CPU1	-	WAR	swHandleRemoveExtender(): EXT=10173372
2011-01-01T13:14:05.270	local0	WARN	SWITCH_32P	CPU1	-	WAR	swHandleRemoveExtender(): PORT=3 EXT=10173372:1
2011-01-01T13:14:05.260	local0	INFO	SWITCH_32P	CPU1	-	INF	msSetOutputPort(): OUT=25 IN=0
2011-01-01T13:14:05.260	local0	INFO	SWITCH_32P	CPU1	-	INF	msSetOutputPort(): OUT=3 IN=0
2011-01-01T13:14:05.260	local0	INFO	SWITCH_32P	CPU1	-	INF	swDisconnectPort(): PORT=3
2011-01-01T13:14:03.480	local0	NOTICE	SWITCH_32P	CPU1	-	NOT	swBinRetLogin(): CON=3000 logout user
2011-01-01T13:13:47.010	local0	NOTICE	SWITCH_32P	CPU1	-	NOT	swBinRetLogin(): CON=3000 USER=1 admin
2011-01-01T13:12:53.770	local0	INFO	SWITCH_32P	CPU1	-	INF	msSetOutputPort(): OUT=23 IN=1
2011-01-01T13:12:53.770	local0	INFO	SWITCH_32P	CPU1	-	INF	msSetOutputPort(): OUT=1 IN=23
2011-01-01T13:12:53.770	local0	INFO	SWITCH_32P	CPU1	-	INF	swConnectCpuCon(): CPU=1004 CON=3000
2011-01-01T13:12:53.750	local0	INFO	SWITCH_32P	CPU1	-	INF	msSetOutputPort(): OUT=23 IN=0
2011-01-01T13:12:53.750	local0	INFO	SWITCH_32P	CPU1	-	INF	swDisconnectCon(): CON=3000
2011-01-01T13:12:53.740	local0	INFO	SWITCH_32P	CPU1	-	INF	msSetOutputPort(): OUT=1 IN=0

Figure 216. Syslog Find Function

To find specific Syslog messages, proceed as follows:

1. Click the **Find Tab** in the working area. Recorded Syslog messages are displayed in the working area.
2. Enter a search term in the **Find Message** search field.
3. Click the **Find Next** button. The first message with the search term is highlighted.
4. Click the **Find Next** again to find another message with the search term.

## System Check

System Check provides a diagnostic tool for checking the matrix configuration. This feature detects and displays suboptimal and faulty settings. It is used as a confidence check and does not make any changes in the configuration. It is accessed through the Java Tool.

The following configuration details are checked:

- Matrix Firmware
- Extender Firmware
- Macros
- System Configuration
- Ports
- Ext Units
- CPU Devices
- CON Devices
- User

→ Select **Device > System Check** in the menu bar, or click the **System Check** icon in the tool bar.

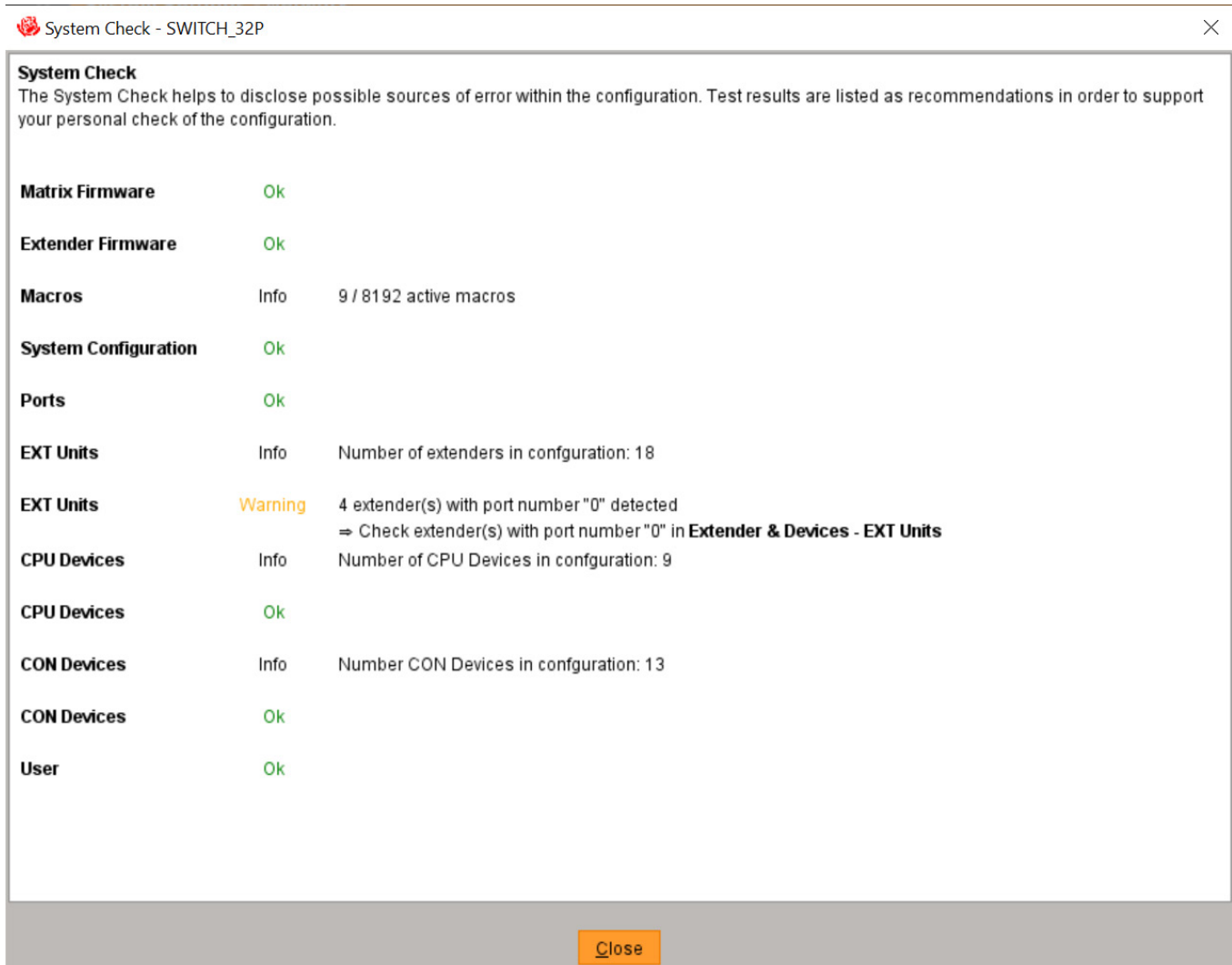

Figure 217. System Check with the Java Tool

The following notification levels are shown:

<b>Level</b>	<b>Description</b>
<b>OK (green)</b>	System Check completed without any abnormalities.
<b>WARNING (yellow)</b>	System Check found abnormalities in the configuration that are not system critical, such as incomplete parts of the configuration, firmware differences, duplications or unconnected extenders.
<b>ERROR (red)</b>	System Check found errors in the configuration that can have both functional and system critical influences on the system.

**Table 86. System Check Notification Levels**

If "WARNING" and "ERROR" messages are generated by the System Check function, the problem will be described and a basic guideline to resolve the problem will be provided.

# SERVICE AND TECHNICAL SUPPORT

---

---

## Repair

---

This Unit does not contain any internal user-serviceable parts. In the event a Unit needs repair, you must first obtain a Return Authorization (RA) number from Rose Electronics or an authorized repair center. This Return Authorization number must appear on the outside of the shipping container.

See Limited Warranty for more information.

When returning a Unit, it should be double-packed in the original container or equivalent, insured and shipped to:

Rose Electronics

Attn: RA \_\_\_\_\_

10707 Stancliff Road

Houston, Texas 77099 USA

## Technical Support

---

If you are experiencing problems, or need assistance in setting up, configuring or operating your Orion FX unit, consult the appropriate sections of this manual. If, however, you require additional information or assistance, please contact the Rose Electronics Technical Support Department at:

Phone: (281) 933-7673

E-mail: [TechSupport@rose.com](mailto:TechSupport@rose.com)

Web: [www.rose.com](http://www.rose.com)

Technical Support hours are from: 8:00 am to 6:00 pm CST (USA), Monday through Friday.

Please report any malfunctions in the operation of this Unit or any discrepancies in this manual to the Rose Electronics Technical Support Department.

# SAFETY

---

## Safety

---

The Orion FX has been tested for conformance to safety regulations and requirements, and has been certified for international use. Like all electronic equipment, the Orion FX should be used with care. To protect yourself from possible injury and to minimize the risk of damage to the Unit, read and follow these safety instructions.

- Follow all instructions and warnings marked on this Unit.
- Except where explained in this manual, do not attempt to service this unit yourself.
- Do not use this unit near water.
- Assure that the placement of this unit is on a stable surface or rack mounted.
- Provide proper ventilation and air circulation.
- Keep power cord and connection cables clear of obstructions that might cause damage to them.
- Use only power cords, power adapter and connection cables designed for this Unit.
- Use only a grounded (three-wire) electrical outlet.
- Use only the power adapter provided with the unit.
- Keep objects that might damage this Unit and liquids that may spill, clear from this Unit. Liquids and foreign objects might come in contact with voltage points that could create a risk of fire or electrical shock.
- Operate this Unit only when the cover is in place.
- Do not use liquid or aerosol cleaners to clean this Unit. Always unplug this Unit from its electrical outlet before cleaning.

Unplug this Unit from the electrical outlet and refer servicing to a qualified service center if any of the following conditions occur:

- The power cord or connection cables are damaged or frayed.
- The Unit has been exposed to any liquids.
- The Unit does not operate normally when all operating instructions have been followed.
- The Unit has been dropped or the case has been damaged.
- The Unit exhibits a distinct change in performance, indicating a need for service.

# MAINTENANCE

---

---

## Safety and EMC Regulatory Statements

Safety information



Documentation reference symbol. If the product is marked with this symbol, refer to the product documentation to get more information about the product.

**WARNING** A WARNING in the manual denotes a hazard that can cause injury or death.

**CAUTION** A CAUTION in the manual denotes a hazard that can damage equipment.

Do not proceed beyond a WARNING or CAUTION notice until you have understood the hazardous conditions and have taken appropriate steps.

### Grounding

There must be an un-interruptible safety earth ground from the main power source to the product's input wiring terminals, power cord, or supplied power cord set. Whenever it is likely that the protection has been impaired, disconnect the power cord until the ground has been restored.

### Service

The Orion FX contains no user serviceable parts. Only service-trained personnel must perform any servicing, maintenance, or repair of all other parts.

# TROUBLESHOOTING

## Troubleshooting

This section provides solutions for problems with the Orion FX matrix. It is assumed that fully operational CPU and CON Devices are available, which can be tested over a peer-to-peer connection using CATx or fiber cables. Please refer to the Orion Xtender manuals, if necessary.

### External Failure

Problem	Possible Reason	Solution
Matrix will not power up	Fuse at the standard appliance outlet	→ Check the fuse

Table 87. Troubleshooting an External Failure

### Video Interference

Problem	Possible Reason	Solution
Unable to open OSD	OSD Jumper not set on user's extender unit	→ Set jumper 11 on user's extender unit
Incorrect video display	Cable connection faulty	→ Check the connections, length and quality of the interconnect cables to the units

Table 88. Troubleshooting Video Interference

### Fan Malfunction

Problem	Possible Reason	Solution
Fans do not run, <b>OK</b> LED on	Fans defective	→ Contact Rose Electronics

Table 89. Troubleshooting a Fan Malfunction

### Power Supply Unit Malfunction

Problem	Possible Reason	Solution
Matrix cannot be started	No power available	→ Check that the power supply cables are connected properly
	Power Supply Units are not switched on	→ Check switch position of the Power Supply Units

Table 90. Troubleshooting a Power Supply Unit Malfunction

## Network Error

Problem	Possible Reason	Solution
Network settings are not in use after editing	Restart of the matrix not yet completed	→ Restart the matrix

**Table 91. Troubleshooting a Network Error**

## Failure at the matrix

Problem	Possible Reason	Solution
USB 2.0 Port definitions invalid	Restart of the matrix not yet completed	→ Restart the matrix
No OSD access	Wrong Hot Key	→ Reset Hot Key if necessary

**Table 92. Troubleshooting a Failure at the Matrix**

## Port Interconnect Failure

*Error Indication at the 1G CATx port*

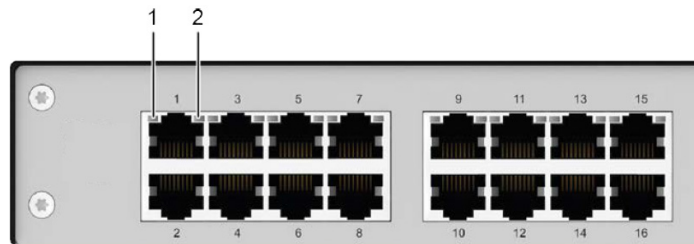

**Figure 218. Troubleshooting a 1G CATx Port Error**

Problem	Possible Reason	Solution
LED 1 or LED 2 flashing orange	Connections between CON Unit, matrix, and CPU Unit	<ul style="list-style-type: none"> <li>→ Check connecting cables and connectors (cable break, CPU/CON Unit offline)</li> <li>→ Connect a 1G extender to a 1G port</li> <li>→ Contact Rose Electronics if necessary</li> </ul>

**Table 93. Troubleshooting a 1G CATx Port Error**

## Error Indication at the 3G CATx Port

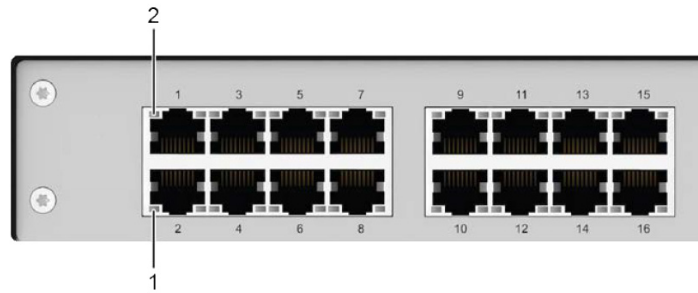

Figure 219. Troubleshooting a 3G CATx Port Error

Problem	Possible Reason	Solution
LED 1 or LED 2 flashing orange	Connections between CON Unit, matrix, and CPU Unit	<ul style="list-style-type: none"> <li>➔ Check connecting cables and connectors (cable break, CPU/CON Unit offline)</li> <li>➔ Connect a 3G extender to a 3G port</li> <li>➔ Contact Rose Electronics if necessary</li> </ul>

Table 94. Troubleshooting a 3G CATx Port Error

## Error Indication at the Fiber Port

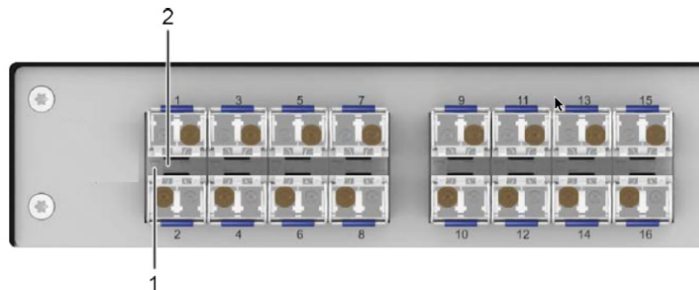

Figure 220. Troubleshooting a Fiber Port Error

Problem	Possible Reason	Solution
LED 1 or LED 2 flashing red	Connections between CON Unit, matrix, and CPU Unit	<ul style="list-style-type: none"> <li>➔ Check connecting cables and connectors (cable break, CPU/CON Unit offline)</li> <li>➔ Connect a 3G extender to a 3G port</li> <li>➔ Contact Rose Electronics if necessary</li> </ul>

Table 95. Troubleshooting a Fiber Port Error

# Blank Screen

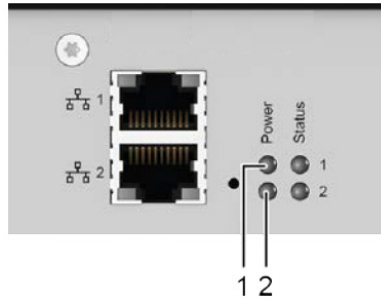

Figure 221. Troubleshooting Blank Screen

Problem	Possible Reason	Solution
LED 1 and LED 2 off	Power supply	→ Check the connection to the power source
Monitor remains dark after switching operation	Switching to a port with no connected source	→ Switch to a port with a connected source
	Connections between CON Unit, matrix, and CPU Unit	→ Check connecting cables and connectors (Cable missing or broken, CPU/CON unit offline, CPU/CON unit connected to the wrong port).

Table 96. Troubleshooting a Blank Screen

## Appendix A – General Specifications

This section gives the general specifications for the Orion FX connectors, pinouts, cables and dimensions.

### Link Bandwidth and Distance

Port Type	Bandwidth
CATx 1G / Fiber 1G	1.25 Gbit/s CATx 3G / Fiber 3G (1000BASE-T)
CATx 3G / Fiber 3G	3.125 Gbit/s (2.5GBASE-T)
Port Type	Distance
CATx 1G <sup>1,2</sup>	460 ft (140 m)
CATx 3G <sup>1,2</sup>	328 ft (100 m)
Fiber 1G SM module <sup>3</sup>	SM OS1/OS2: 32,808 ft (10 km) MM OM3: 984 ft (300 m) Estimated
Fiber 1G MM module <sup>4</sup>	MM OM1: 721 ft (220 m) MM OM3: 1804 ft (550 m)
Fiber 3G SM module	SM OS1/OS2: 16,404 ft (5 km)
<p><i>Notes:</i></p> <p>(1) CAT5e cabling is rated for 1000BASE-T and can also handle 2.5GBASE-T over shorter runs. Consider using CAT6 cable for longer runs..</p> <p>(2) When using AWG26/28 CATx stranded wire patch cables, the maximum extension distance is decreased by an estimated 50%.</p> <p>(3) Fiber 1G single-mode SFP module supplied is type LX 310nm, which supports both single-mode and multi-mode OM3 or higher. Increased multi-mode distance can be achieved with a mode conditioning cable. Test with multi-mode before installation.</p> <p>(4) Fiber 1G multi-mode SFP module supplied is type SX 850nm, which supports legacy OM1 cable and longer distance with OM3 than single-mode SFP module. No mode conditioning cable is required.</p> <p>(5) There are further unspecified options for the fiber SFP modules such as long haul, bidirectional, or CWDM. Please contact the Rose sales department for more information.</p>	

**Table 97. Link Bandwidth and Distance**

## Connector Pinouts

This section shows the pinouts for the connectors on the Orion FX.

### RJ45 Connector (Network)

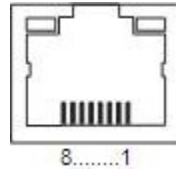

Figure 222. RJ45 Network Connector

Pin	Signal	Pin	Signal
1	D1+	5	D3-
2	D1-	6	D2-
3	D2+	7	D4+
4	D3+	8	D4-

Table 98. RJ45 Network Connector Pinouts

### RJ45 Connector (Interconnect)

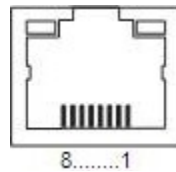

Figure 223. I/O Board RJ45 Connector

Pin	Signal	Pin	Signal
1	D1+	5	D3-
2	D1-	6	D2-
3	D2+	7	D4+
4	D3+	8	D4-

Table 99. I/O Board RJ45 Connector Pinouts

### Fiber SFP Type LC Connector

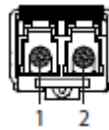

Figure 224. I/O Port Fiber Type LC Connector

Diode	Signal
1	Data OUT
2	Data IN

Table 100. I/O Port Fiber Type LC Connector Pinouts

## Maximum Current, Voltage, and Power Consumption

### Orion FX, CATx 1G

<b>Orion FX 8-port model</b>	AC Power:0,7 A, 100-240 Vac, 50/60 Hz	13 W
	Redundant DC Power: 5A, 5V	13 W
<b>Orion FX 16-port model</b>	3.9 A, 100-240 VAC, 50/60 Hz	53.7 W
<b>Orion FX 24-port model</b>	5.1 A, 100-240 VAC, 50/60 Hz	69.3 W
<b>Orion FX 32-port model</b>	6.2 A, 100-240 VAC, 50/60 Hz	85.0 W
<b>Orion FX 40-port model</b>	7.3 A, 100-240 VAC, 50/60 Hz	100.6 W
<b>Orion FX 48-port model</b>	9.6 A, 100-240 VAC, 50/60 Hz	126.6 W
<b>Orion FX 64-port model</b>	11.9 A, 100-240 VAC, 50/60 Hz	157.4 W
<b>Orion FX 80-port model</b>	14.3 A, 100-240 VAC, 50/60 Hz	188.1 W
<b>Orion FX 120-port model</b>	21.9 A, 100-240 VAC, 50/60 Hz	279.6 W
<b>Orion FX 128-port model</b>	23.1 A, 100-240 VAC, 50/60 Hz	294.5 W
<b>Orion FX 144-port model</b>	25.4 A, 100-240 VAC, 50/60 Hz	324.3 W
<b>Orion FX 160-port model</b>	27.8 A, 100-240 VAC, 50/60 Hz	354.0 W

Table 101. Current and Voltage and Power Requirements for the Orion FX CATx 1G

### Orion FX, CATx 3G

<b>Orion FX 16-port model</b>	5.3 A, 100-240 VAC, 50/60 Hz	72.9 W
<b>Orion FX 24-port model</b>	7.2 A, 100-240 VAC, 50/60 Hz	98.1 W
<b>Orion FX 32-port model</b>	9.0 A, 100-240 VAC, 50/60 Hz	123.4 W
<b>Orion FX 40-port model</b>	10.8 A, 100-240 VAC, 50/60 Hz	148.6 W
<b>Orion FX 48-port model</b>	13.8 A, 100-240 VAC, 50/60 Hz	182.0 W
<b>Orion FX 64-port model</b>	17.5 A, 100-240 VAC, 50/60 Hz	231.2 W
<b>Orion FX 80-port model</b>	21.3 A, 100-240 VAC, 50/60 Hz	280.4 W
<b>Orion FX 120-port model</b>	32.4 A, 100-240 VAC, 50/60 Hz	413.6 W
<b>Orion FX 128-port model</b>	34.3 A, 100-240 VAC, 50/60 Hz	437.4 W
<b>Orion FX 144-port model</b>	38.0 A, 100-240 VAC, 50/60 Hz	485.1 W
<b>Orion FX 160-port model</b>	41.8 A, 100-240 VAC, 50/60 Hz	532.8 W

Table 102. Current and Voltage and Power Requirements for the Orion FX CATx 3G

## Orion FX, Fiber 1G and 3G

<b>Orion FX 8-port model</b>	AC Power:0,7 A, 100-240 Vac, 50/60 Hz	13 W
	Redundant DC Power: 5A, 5V	13 W
<b>Orion FX 16-port model</b>	3.9 A, 100-240 VAC, 50/60 Hz	53.7 W
<b>Orion FX 24-port model</b>	5.1 A, 100-240 VAC, 50/60 Hz	69.3 W
<b>Orion FX 32-port model</b>	6.2 A, 100-240 VAC, 50/60 Hz	85.0 W
<b>Orion FX 40-port model</b>	7.4 A, 100-240 VAC, 50/60 Hz	100.6 W
<b>Orion FX 48-port model</b>	9.6 A, 100-240 VAC, 50/60 Hz	126.6 W
<b>Orion FX 64-port model</b>	11.9 A, 100-240 VAC, 50/60 Hz	157.4 W
<b>Orion FX 80-port model</b>	14.3 A, 100-240 VAC, 50/60 Hz	188.1 W
<b>Orion FX 120-port model</b>	21.9 A, 100-240 VAC, 50/60 Hz	279.6 W
<b>Orion FX 128-port model</b>	23.1 A, 100-240 VAC, 50/60 Hz	294.5 W
<b>Orion FX 144-port model</b>	25.4 A, 100-240 VAC, 50/60 Hz	324.3 W
<b>Orion FX 160-port model</b>	27.7 A, 100-240 VAC, 50/60 Hz	354.0 W

Table 103. Current and Voltage and Power Requirements for the Orion FX CATx 3G

## Orion FX Mixed Port Models 1G

<b>Orion FX 24 CATx 16 Fiber port model</b>	7.3 A, 100-240 Vac, 50/60 Hz	100.6 W
<b>Orion FX 24 CATx 40 Fiber port model</b>	11.9 A, 100-240 VAC, 50/60 Hz	157.4 W
<b>Orion FX 40 CATx 24 Fiber port model</b>	11.9 A, 100-240 VAC, 50/60 Hz	157.4 W
<b>Orion FX 40 CATx 40 Fiber port model</b>	14.3 A, 100-240 VAC, 50/60 Hz	188.1 W
<b>Orion FX 80 CATx 40 Fiber port model</b>	21.9 A, 100-240 VAC, 50/60 Hz	279.6 W
<b>Orion FX 80 CATx 80 Fiber port model</b>	27.7 A, 100-240 VAC, 50/60 Hz	354.0 W
<b>Orion 120 CATx 40 Fiber port model</b>	27.7 A, 100-240 VAC, 50/60 Hz	354.0 W

Table 104. Current and Voltage and Power Requirements for the Orion FX Mixed Port Models 1G

## Orion FX Mixed Port Models 3G

<b>Orion FX 24 CATx 16 Fiber port model</b>	9.4 A, 100-240 Vac, 50/60 Hz	129.4 W
<b>Orion FX 24 CATx 40 Fiber port model</b>	14.0 A, 100-240 VAC, 50/60 Hz	185.1 W
<b>Orion FX 40 CATx 24 Fiber port model</b>	17.4 A, 100-240 VAC, 50/60 Hz	229.9 W
<b>Orion FX 40 CATx 40 Fiber port model</b>	17.8 A, 100-240 VAC, 50/60 Hz	234.3 W
<b>Orion FX 80 CATx 40 Fiber port model</b>	28.1 A, 100-240 VAC, 50/60 Hz	358.3 W
<b>Orion FX 80 CATx 80 Fiber port model</b>	33.1 A, 100-240 VAC, 50/60 Hz	422.1 W
<b>Orion 120 CATx 40 Fiber port model</b>	37.4 A, 100-240 VAC, 50/60 Hz	477.4 W

Table 105. Current and Voltage and Power Requirements for the Orion FX Mixed Port Models 3G

## Environmental Conditions

<b>Operating Temperature</b>	41 °F to 113 °F (5 °C to 45 °C)
<b>Storage Temperature</b>	-13 °F to 140 °F (-25 °C to 60 °C)
<b>Relative Humidity</b>	Max. 80% non-condensing
<b>Operating Altitude</b>	Max. 8200 ft (2. 5km)
<b>Heat Dissipation</b>	Corresponds to power consumption in Watts

Table 106. Environmental Conditions Requirements for the Orion X

## MTBF

The following table contains the mean time between failure (MTBF) in power-on hours (POH). The estimate is based on the FIT rates of the parts included. FIT rates are based on normalized environmental conditions of T = 140 °F and activation energy (Ea.) of 0.7 eV. Calculations are based on 90% confidence limit.

It is estimated that temperature inside the housing will be 59°F higher than the ambient temperature. Therefore, the MTBF calculation refers to an ambient temperature of 113 °F. The humidity is limited to 60%.

<b>Model</b>	<b>MTBF, POH</b>
<b>Orion FX 1U models (16-, 24-, 32-, and 40-port)</b>	71,900
<b>Orion FX 2U models (48-, 64-, and 80-port)</b>	74,300
<b>Orion FX 4U models (120-, 128-, 144-, and 160-port)</b>	65,400
<b>CATx 1G I/O modules</b>	899,200
<b>CATx 3G I/O modules</b>	474,800
<b>Fiber 1G and 3G modules (without SFP)</b>	878,700

Table 107. MTBF Values for the Orion FX

## Dimensions

### *Orion FX 120-port, 128-port, 144-port, and 160-port (4U)*

<b>Matrix</b>	17.4 in x 17.7 in x 7.0 in (442 x 449 x 177 mm)
<b>Shipping Box</b>	25.2 in x 22.4 in x 14.2 in (640 x 570 x 360 mm)

**Table 108. Size of the 4U Orion FX model and its Shipping Box**

### *Orion FX 48-port, 64-port, and 80-port models (2U)*

<b>Matrix</b>	17.4 in x 17.7 in x 3.5 in (442 x 449 x 90 mm)
<b>Shipping Box</b>	23.7 in x 20.7 in x 7.9 in (602 x 526 x 208 mm)

**Table 109. Size of the 2U Orion FX model and its Shipping Box**

### *Orion FX 16-port, 24-port, 32-port, and 40-port models (1U)*

<b>Matrix</b>	17.4 in x 17.7 in x 1.7 in (442 x 449 x 44 mm)
<b>Shipping Box</b>	23.7 in x 20.7 in x 6.1 in (602 x 526 x 154 mm)

**Table 110. Size of the 1U Orion FX model and its Shipping Box**

### *Orion FX 8-port models (1U Half-Width)*

<b>Matrix</b>	8.7 in x 5.7 in x 1.7 in (220 x 146 x 44 mm)
<b>Shipping Box</b>	21.7 in x 14.4 in x 4.5 in (550 x 365 x 115 mm)

**Table 111. Size of the 8-Port Orion FX model and its Shipping Box**

## Weight

### *Orion FX 120-port, 128-port, 144-port, and 160-port (4U)*

<b>Matrix</b>	41.9 lb. (19.6 kg)
---------------	--------------------

**Table 112. Shipping Weight of the 4U Orion FX**

### *Orion FX 48-port, 64-port, and 80-port models (2U)*

<b>Matrix</b>	24.3 lb. (11 kg)
---------------	------------------

**Table 113. Shipping Weight of the 2U Orion FX**

### *Orion FX 16-port, 24-port, 32-port, and 40-port models (1U)*

<b>Matrix</b>	17 lb. (7.7 kg)
---------------	-----------------

**Table 114. Shipping Weight of the 1U Orion FX**

### *Orion FX 8-port models (1U Half-Width)*

<b>Matrix</b>	17 lb. (7.7 kg)
---------------	-----------------

**Table 115. Shipping Weight of the 8-Port Orion FX**

## Appendix B – Part numbers

Orion FX switch – CATx ports 1G	
OXS-FX008-TP	Orion FX, 8 port matrix switch, redundant DC power, CATx, 1G, 1U
OXS-FX016-TP	Orion FX, 16 port matrix switch, redundant PSU, CATx, 1G, 1U
OXS-FX024-TP	Orion FX, 24 port matrix switch, redundant PSU, CATx, 1G, 1U
OXS-FX032-TP	Orion FX, 32 port matrix switch, redundant PSU, CATx, 1G, 1U
OXS-FX040-TP	Orion FX, 40 port matrix switch, redundant PSU, CATx, 1G, 1U
OXS-FX048-TP	Orion FX, 48 port matrix switch, redundant PSU, CATx, 1G, 2U
OXS-FX064-TP	Orion FX, 64 port matrix switch, redundant PSU, CATx, 1G, 2U
OXS-FX080-TP	Orion FX, 80 port matrix switch, redundant PSU, CATx, 1G, 2U
OXS-FX0120-TP	Orion FX, 120 port matrix switch, redundant PSU, CATx, 1G, 4U
OXS-FX0128-TP	Orion FX, 128 port matrix switch, redundant PSU, CATx, 1G, 4U
OXS-FX0144-TP	Orion FX, 144 port matrix switch, redundant PSU, CATx, 1G, 4U
OXS-FX0160-TP	Orion FX, 160 port matrix switch, redundant PSU, CATx, 1G, 4U

**Table 116. Part Numbers for Orion FX Units with CATx 1G Ports**

Orion FX switch – CATx ports 3G	
OXS-FX016-T3	Orion FX, 16 port matrix switch, redundant PSU, CATx, 3G, 1U
OXS-FX024-T3	Orion FX, 24 port matrix switch, redundant PSU, CATx, 3G, 1U
OXS-FX032-T3	Orion FX, 32 port matrix switch, redundant PSU, CATx, 3G, 1U
OXS-FX040-T3	Orion FX, 40 port matrix switch, redundant PSU, CATx, 3G, 1U
OXS-FX048-T3	Orion FX, 48 port matrix switch, redundant PSU, CATx, 3G, 2U
OXS-FX064-T3	Orion FX, 64 port matrix switch, redundant PSU, CATx, 3G, 2U
OXS-FX080-T3	Orion FX, 80 port matrix switch, redundant PSU, CATx, 3G, 2U
OXS-FX0120-T3	Orion FX, 120 port matrix switch, redundant PSU, CATx, 3G, 4U
OXS-FX0128-T3	Orion FX, 128 port matrix switch, redundant PSU, CATx, 3G, 4U
OXS-FX0144-T3	Orion FX, 144 port matrix switch, redundant PSU, CATx, 3G, 4U
OXS-FX0160-T3	Orion FX, 160 port matrix switch, redundant PSU, CATx, 3G, 4U

**Table 117. Part Numbers for Orion FX Units with CATx 3GPorts**

<b>Orion FX switch – Fiber single mode ports 1G</b>	
OXS-FX008-FS	Orion FX, 8 port matrix switch, redundant DC Power, Fiber SM, 1G, 1U
OXS-FX016-FS	Orion FX, 16 port matrix switch, redundant PSU, Fiber SM, 1G, 1U
OXS-FX024-FS	Orion FX, 24 port matrix switch, redundant PSU, Fiber SM, 1G, 1U
OXS-FX032-FS	Orion FX, 32 port matrix switch, redundant PSU, Fiber SM, 1G, 1U
OXS-FX040-FS	Orion FX, 40 port matrix switch, redundant PSU, Fiber SM, 1G, 1U
OXS-FX048-FS	Orion FX, 48 port matrix switch, redundant PSU, Fiber SM, 1G, 2U
OXS-FX064-FS	Orion FX, 64 port matrix switch, redundant PSU, Fiber SM, 1G, 2U
OXS-FX080-FS	Orion FX, 80 port matrix switch, redundant PSU, Fiber SM, 1G, 2U
OXS-FX0120-FS	Orion FX, 120 port matrix switch, redundant PSU, Fiber SM, 1G, 4U
OXS-FX0128-FS	Orion FX, 128 port matrix switch, redundant PSU, Fiber SM, 1G, 4U
OXS-FX0144-FS	Orion FX, 144 port matrix switch, redundant PSU, Fiber SM, 1G, 4U
OXS-FX0160-FS	Orion FX, 160 port matrix switch, redundant PSU, Fiber SM, 1G, 4U

**Table 118. Part Numbers for Orion FX Units with Fiber Single Mode 1G Ports**

<b>Orion FX switch – Fiber multi mode ports 1G</b>	
OXS-FX008-FM	Orion FX, 8 port matrix switch, redundant DC Power, Fiber MM, 1G, 1U
OXS-FX016-FM	Orion FX, 16 port matrix switch, redundant PSU, Fiber MM, 1G, 1U
OXS-FX024-FM	Orion FX, 24 port matrix switch, redundant PSU, Fiber MM, 1G, 1U
OXS-FX032-FM	Orion FX, 32 port matrix switch, redundant PSU, Fiber MM, 1G, 1U
OXS-FX040-FM	Orion FX, 40 port matrix switch, redundant PSU, Fiber MM, 1G, 1U
OXS-FX048-FM	Orion FX, 48 port matrix switch, redundant PSU, Fiber MM, 1G, 2U
OXS-FX064-FM	Orion FX, 64 port matrix switch, redundant PSU, Fiber MM, 1G, 2U
OXS-FX080-FM	Orion FX, 80 port matrix switch, redundant PSU, Fiber MM, 1G, 2U
OXS-FX0120-FM	Orion FX, 120 port matrix switch, redundant PSU, Fiber MM, 1G, 4U
OXS-FX0128-FM	Orion FX, 128 port matrix switch, redundant PSU, Fiber MM, 1G, 4U
OXS-FX0144-FM	Orion FX, 144 port matrix switch, redundant PSU, Fiber MM, 1G, 4U
OXS-FX0160-FM	Orion FX, 160 port matrix switch, redundant PSU, Fiber MM, 1G, 4U

**Table 119. Part Numbers for Orion FX Units with Fiber Multi Mode 1G Ports**

<b>Orion FX switch - Fiber single mode ports 3G</b>	
OXS-FX008-F3	8 port matrix switch, redundant DC Power, Fiber SM, 3G, 1U
OXS-FX016-F3	Orion FX, 16 port matrix switch, redundant PSU, Fiber SM, 3G, 1U
OXS-FX024-F3	Orion FX, 24 port matrix switch, redundant PSU, Fiber SM, 3G, 1U
OXS-FX032-F3	Orion FX, 32 port matrix switch, redundant PSU, Fiber SM, 3G, 1U
OXS-FX040-F3	Orion FX, 40 port matrix switch, redundant PSU, Fiber SM, 3G, 1U
OXS-FX048-F3	Orion FX, 48 port matrix switch, redundant PSU, Fiber SM, 3G, 2U
OXS-FX064-F3	Orion FX, 64 port matrix switch, redundant PSU, Fiber SM, 3G, 2U
OXS-FX080-F3	Orion FX, 80 port matrix switch, redundant PSU, Fiber SM, 3G, 2U
OXS-FX0120-F3	Orion FX, 120 port matrix switch, redundant PSU, Fiber SM, 3G, 4U
OXS-FX0128-F3	Orion FX, 128 port matrix switch, redundant PSU, Fiber SM, 3G, 4U
OXS-FX0144-F3	Orion FX, 144 port matrix switch, redundant PSU, Fiber SM, 3G, 4U
OXS-FX0160-F3	Orion FX, 160 port matrix switch, redundant PSU, Fiber SM, 3G, 4U

**Table 120. Part Numbers for Orion FX Units with Fiber Single Mode 3G Ports**

Note: The Orion FX CATx and fiber singlemode switches (1G) are externally identical to the CATx and fiber singlemode switches (3G)

<b>Orion FX switch - Hybrid ports - mixed CATx and fiber 1G</b>	
OXS-FX24TP16FS	Orion FX, 40 port hybrid matrix switch, redundant PSU, 24×CATx, 16×FS, 1G, 1U
OXS-FX24TP40FS	Orion FX, 64 port hybrid matrix switch, redundant PSU, 24×CATx, 40×FS, 1G, 2U
OXS-FX40TP24FS	Orion FX, 64 port hybrid matrix switch, redundant PSU, 40×CATx, 24×FS, 1G, 2U
OXS-FX40TP40FS	Orion FX, 80 port hybrid matrix switch, redundant PSU, 40×CATx, 40×FS, 1G, 2U
OXS-FX80TP40FS	Orion FX, 120 port hybrid matrix switch, redundant PSU, 80×CATx, 40×FS, 1G, 4U
OXS-FX80TP80FS	Orion FX, 160 port hybrid matrix switch, redundant PSU, 80×CATx, 80×FS, 1G, 4U
OXS-FX120TP40FS	Orion FX, 160 port hybrid matrix switch, redundant PSU, 120×CATx, 40×FS, 1G, 4U

**Table 121. Part Numbers for Orion FX Units with Mixed CATx and Fiber 1G Ports**

<b>Orion FX switch - Hybrid ports - mixed CATx and fiber 3G</b>	
OXS-FX24T316F3	Orion FX, 40 port hybrid matrix switch, redundant PSU, 24×CATx, 16×FS, 3G, 1U
OXS-FX24T340F3	Orion FX, 64 port hybrid matrix switch, redundant PSU, 24×CATx, 40×FS, 3G, 2U
OXS-FX40T324F3	Orion FX, 64 port hybrid matrix switch, redundant PSU, 40×CATx, 24×FS, 3G, 2U
OXS-FX40T340F3	Orion FX, 80 port hybrid matrix switch, redundant PSU, 40×CATx, 40×FS, 3G, 2U
OXS-FX80T340F3	Orion FX, 120 port hybrid matrix switch, redundant PSU, 80×CATx, 40×FS, 3G, 4U
OXS-FX80T380F3	Orion FX, 160 port hybrid matrix switch, redundant PSU, 80×CATx, 80×FS, 3G, 4U
OXS-FX120T340F3	Orion FX, 160 port hybrid matrix switch, redundant PSU, 120×CATx, 40×FS, 3G, 4U

**Table 122. Part Numbers for Orion FX Units with Mixed CATx and Fiber 3G Ports**

<b>Orion FX switch - Matrix-Grid version - 1G</b>	
OXS-FX032G-TP	Orion FX, 32 port matrix switch, redundant PSU, 32×CATx + Matrix-Grid, 1G, 1U
OXS-FX032G-FS	Orion FX, 32 port matrix switch, redundant PSU, 32×Fiber + Matrix-Grid, 1G, 1U

**Table 123. Part Numbers for Orion FX Units Matrix Grid Version with 1G Ports**

<b>Orion FX switch – Custom design version – with expansion capability in a 2U chassis, 1G and 3G</b>	
OXS-FX040-TP-2U	Orion FX, 40 port matrix switch, redundant PSU, 40×CATx in a 2U chassis, 1G
OXS-FX040-FS-2U	Orion FX, 40 port matrix switch, redundant PSU, 40×Fiber in a 2U chassis, 1G
OXS-FX040-T3-2U	Orion FX, 40 port matrix switch, redundant PSU, 40×CATx in a 2U chassis, 3G
OXS-FX040-F3-2U	Orion FX, 40 port matrix switch, redundant PSU, 40×Fiber in a 2U chassis, 3G
OXS-FX24TP16FS-2U	Orion FX, 40 port matrix switch, redundant PSU, 40×CATx, 16×FS in a 2U chassis, 1G
OXS-FX24T316F3-2U	Orion FX, 40 port matrix switch, redundant PSU, 40×CATx, 16×FS in a 2U chassis, 3G
OXS-FX032G-TP-2U	Orion FX, 32 port matrix switch, redundant PSU, 32×CATx + Matrix-Grid in a 2U chassis, 1G
OXS-FX032G-FS-2U	Orion FX, 32 port matrix switch, redundant PSU, 32×Fiber + Matrix-Grid in a 2U chassis, 1G

**Table 124. Part Numbers for Orion FX Units with Expansion Capability in a 2U Chassis**

<b>Orion FX switch – Custom design version – with expansion capability in a 4U chassis, 1G and 3G</b>	
OXS-FX040-TP-4U	Orion FX, 40 port matrix switch, redundant PSU, 40×CATx in a 4U chassis, 1G
OXS-FX040-FS-4U	Orion FX, 40 port matrix switch, redundant PSU, 40×Fiber in a 4U chassis, 1G
OXS-FX040-T3-4U	Orion FX, 40 port matrix switch, redundant PSU, 40×CATx in a 4U chassis, 3G
OXS-FX040-F3-4U	Orion FX, 40 port matrix switch, redundant PSU, 40×Fiber in a 4U chassis, 3G
OXS-FX24TP16FS-4U	Orion FX, 40 port matrix switch, redundant PSU, 40×CATx, 16×FS in a 4U chassis, 1G
OXS-FX24T316F3-4U	Orion FX, 40 port matrix switch, redundant PSU, 40×CATx, 16×FS in a 4U chassis, 3G
OXS-FX032G-TP-4U	Orion FX, 32 port matrix switch, redundant PSU, 32×CATx + Matrix-Grid in a 4U chassis, 1G
OXS-FX032G-FS-4U	Orion FX, 32 port matrix switch, redundant PSU, 32×Fiber + Matrix-Grid in a 4U chassis, 1G

**Table 125. Part Numbers for Orion FX Units with Expansion Capability in a 4U Chassis**

<b>Transformer for 8-port Orion FX switch</b>	
TFR-05D500FSUB/2.5F	5A, 5V Transformer for redundant power on Orion FX 8-port switches, ordered separately

ROSE.COM

---

**WWW.ROSE.COM** ▪ **sales@rose.com** ▪ **(281) 933-7673**

Rose Electronics ▪ 10707 Stancliff Road ▪ Houston, Texas 77099  
Rose USA (281) 933-7673 ▪ Rose Europe +49 (0) 1762 6730896  
Rose Asia +65 9632 6616 ▪ Rose Australia +61 (0) 421 247083



**WWW.ROSE.COM**